

Hyperbaric Oxygen Chamber

(Capsule Style)

Model: TimeCapsule C900M



About Hyperbaric Oxygen Therapy (HBOT):

Hyperbaric oxygen therapy (HBOT) is well known for treating scuba and deep-sea divers affected by the rapid change in pressure around them. But did you know that HBOT is also used to treat a variety of other health problems, including carbon monoxide poisoning and diabetic foot ulcers.

Hyperbaric oxygen therapy treats chronic wounds and other medical conditions. Room air contains 21% oxygen, while hyperbaric oxygen therapy provides you with air that contains 100% oxygen. A pressurized chamber delivers oxygen that's two to three times higher than normal air pressure, which helps your lungs gather and absorb more oxygen. Oxygen helps the tissues in your body heal and withstand infections.

Healthcare providers use hyperbaric oxygen therapy alone or with other medical treatments, such as medications or surgery. Most people receive hyperbaric oxygen therapy on an outpatient basis for one to two hours each session. Depending on the type of treatment, you may sit or lie down during the procedure.

Other names for hyperbaric oxygen therapy include HBO therapy or HBOT

Features:

1. Chamber body Made by 304 stainless steel:
 - Strong weight bearing capacity, up to 300kg;
 - Durable and wear-resistant.
 - non-deformable and long lifespan.
2. With environmental spray paint, Support for color customization.
3. Intelligent oxygen supply system:
 - display parameters(temperature, humidity, oxygen purity and pressure) in real time;
 - adjust the chamber pressure in real time and display it through a curve;
 - with timing functions and maintenance information prompts
 - Interphone system for two-way communication



- Automatic air pressure control system, the door is sealed by pressure.

4. Double operation system:

- Inside and outside control panels, easy to operate.

- Automatic digital display real-time parameters

- Rotary timer system, use of time can be presetted in advance

5. Big windows in front of chamber, Good line of sight and easy to observe the situation inside. The interior space is spacious without feeling oppressive, suitable for claustrophobic users.

6. Security measures: With Manual safety valve and automatic safety valve,

7. ODM & OEM: Customize color for different request.

Specification:

About chamber:

Index	Content
Model Name	uDR C900M
Control System	In-cabin touch screen UI(support multi-langue)
Chamber Material	304 stainless steel + interior soft decoration+ environmental spray paint
Color	White/Grey/Customize
Door Material	Polycarbonate(PC)
Chamber size	Φ900*2160cm
Chamber configuration	As the list below
Diffuse oxygen concentration	≤30%
Working pressure in the chamber	100-130KPa adjustable
Working noise	<30db
Temperature in the chamber	Ambient temperature +3°C (without air conditioner)
Safety Facilities	Manual safety valve, automatic safety valve

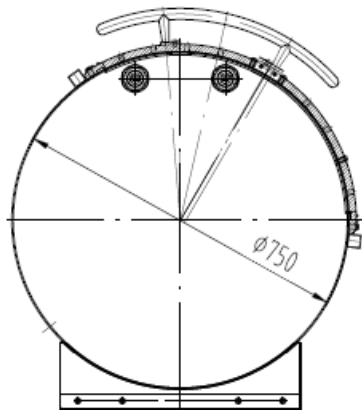
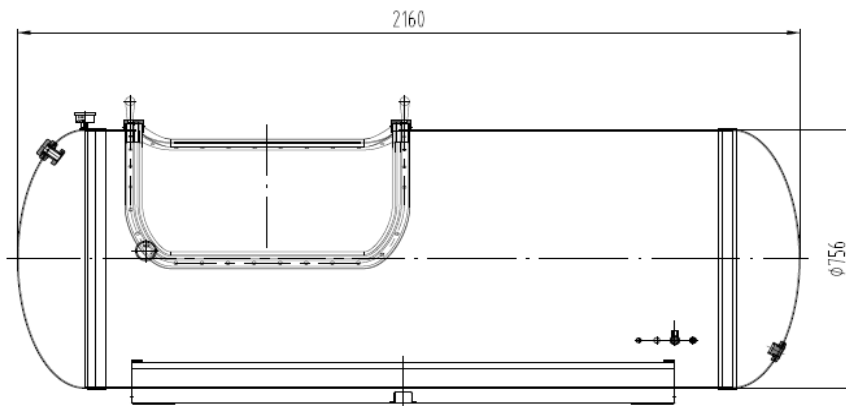

About Oxygen Supply System:

Model	uMR 07+
Size	H902*L520*W570mm
Control System	Touch screen control(10 inch)
Power Supply	AC 100V-240V 50/60Hz
Power	800W
Oxygen Pipe Diameter	8 mm
Air Pipe Diameter	12 mm
Oxygen flow	10L/min
Max airflow	220 L/min
Max Outlet pressure	150KPA(1.5ATA)
Oxygen Purity	96%±3%
Oxygen system	air filter (PSA)
Compressor	Oil-free compressor air delivery system
Noise	≤45db



Appearance:



UI:

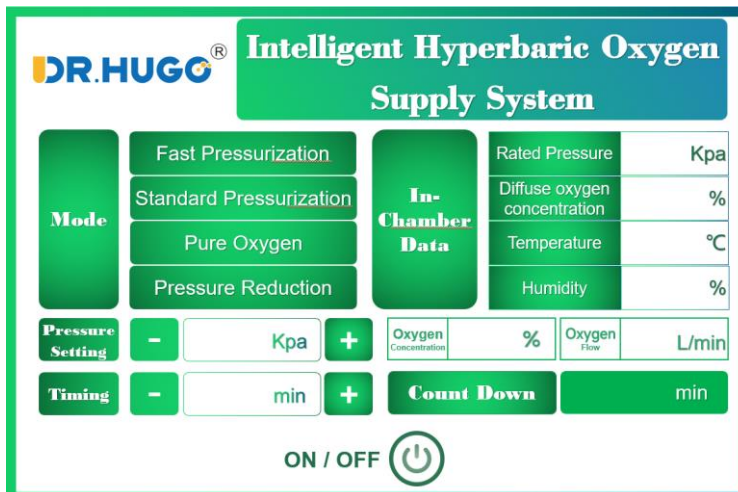

Real-time pressure display:



In-chamber control panel:



Configuration List:

Index	Specification	Unit	QTY
Capsule Style Chamber	Φ900*2160cm	set	1
Oxygen Supply System	Model: uMR O7+	set	1
In-chamber controller (touch screen version)	Standard: integrated pressure, oxygen concentration, temperature, Humidity and can be customize	set	1
Communication System	Internal and external, Dual wireless, Chargeable	set	1
Oxygen Terminal Connector	Medical grade self-locking (national standard)	set	1
Humidification Bottle	Medical grade with regulating valve (national standard)	set	1
Automatic Safety Relief Valve	3.5Psi/4.5Psi/Customize	set	2
Emergency Relief Valve	customize	set	1
Interior Decoration	Bamboo wood fiber, PU leather	set	1
In-cabin Power Supply System	Optional: 12/24V(double voltage) 600W	set	1
Air conditioner for oxygen chamber	Optional : Water-cool air conditioner /500W	set	1



DR.HUGO

Your Oxygen Therapy Expert

POWER BY:



LANNX Bio&Med Co.,Ltd

Website: www.lannx.net/hbot/

E-Mail: sale@lannx.net

-Search our channel in YouTube to view operation video:

<https://www.youtube.com/@oxygensupplycenter>