

Thanks for choosing our products, in order to protect your consumption right and personal safety, please read this instruction carefully before uses and keep this as the future reference.

Attention:

- Before installing the luminaire, please check whether the rated voltage of the luminaire is consistent with the voltage of the wiring power supply to avoid damage to the luminaire due to voltage inconsistency.
- Touching these parts without disconnecting the power supply may cause an electric shock. So, installation must be done by professional electrician.
- Please ensure the power has been cut off before installation, in order to prevent the electric shock, make sure the power supply that can't be resumed by anybody before the job done.
- Keep the surface of the lamp housing and transparent parts clean to ensure good light transmission.
- Plastic materials are used in some parts of the spotlight. Applying organic solvents (such as benzene), or other chemicals for cleaning may cause deformation or discolouration. Clean the device gently, using a soft dry cloth.
- Each fixing screw must be tightened when installing.
- The cable entry line should be fixed and prevented from pulling the wire and damaging the lamp.
- Avoid collision with hard objects to avoid scratches.
- Do not spray or pour water on the unit, this may cause an electric shock.
- Do not install the unit in locations subject to high and/or low temperatures (this may damage the LED lamp).
- The maintenance should be done by the professional. The luminaire must be grounded reliably and non-professionals must not disassemble the luminaire.
- The front-end power supply must be cut off during installation. The power supply must be cut off when repairing or replacing parts.
- The defective ballast could not be treated as the normal rubbish and should be returned and make use of the normal parts.
- Regarding the repair of the equipment contact Technical Support.

Dongguan Fitlight Lighting Co.,Ltd.

Add: 10th floor, building C1, Songhu Zhigu building, No. 9, Yanhe South Road, Liaobu Town, Dongguan City, Guangdong Province, China.

Email : liu@fitlight-tech.com URL: www.fitlight-tech.com / <https://fitlight.en.alibaba.com>

FEITL
 东莞市菲特莱照明有限公司
 DONGGUAN FITLIGHT LIGHTING CO.,LTD

OEM/ODM

Professional Lighting Product Manufacturer

1. 14+ Years of Industry Leadership
2. Full Customization (OEM/ODM)
3. Certified Excellence: Globally recognized certifications (CE, RoHS, SAA, etc.)
4. Energy-Efficient & Sustainable Solutions
5. Competitive Pricing & Fast Turnaround
6. Dedicated R&D & Continuous Innovation

14^{+years}
 Production experience

3000^{+m²}
 Factory space

50⁺
 Patent certificate

100⁺
 Projects

10000^{+pcs}
 Daily output value

100⁺
 Service country



Dongguan Fitlight Lighting Co.,Ltd.

Add: 10th floor, building C1, Songhu Zhigu building, No. 9, Yanhe South Road, Liaobu Town, Dongguan City, Guangdong Province, China.

Email : liu@fitlight-tech.com URL: www.fitlight-tech.com / <https://fitlight.en.alibaba.com>

Features and Benefits

- Light source: COB LED
- Long LED life: More than 50,000 hours
- Low heat, less than 60°C
- No UV or IR light radiation
- No mercury or other inorganic
- Homogeneous flood illumination
- Machined aluminum heat fins with excellent thermal efficiencies
- The LED down light is available in the following white color temperatures: 2700/3000/3500/4000/5000/6000K
- 3 or 5 years limited warranty(3 years for Bridgelux LED chip model and 5 years for OSRAM/CREE LED chip version)
- Works with worldwide lighting systems 110VAC/220VAC



Typical Applications

- Spot lighting
- Retail Store lighting
- Commercial lighting
- Residential lighting
- General lighting
- Energy Saving Programs
- Sustainable Energy



Multiple colors



DC connector with Lock

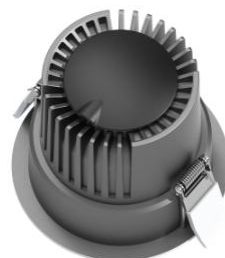

Aluminum Heatsink



Brand Driver

Dongguan Fitlight Lighting Co.,Ltd.

Add: 10th floor, building C1, Songhu Zhigu building, No. 9, Yanhe South Road, Liaobu Town, Dongguan City, Guangdong Province, China.

Email : liu@fitlight-tech.com URL: www.fitlight-tech.com / <https://fitlight.en.alibaba.com>

PRODUCT SPECIFICATIONS

LAMP TYPE	HGS17 Series Colorful Floating Beam Spotlights
LIGHT SOURCE	Cree/OSRAM or Bridgelux COB LED (Other driver brands can also choose from)
Driver	Osram / Tridonic/ LIFUD (Other driver brands can also choose from)
Input voltage (volts)	AC 110V (± 10%)/AC 220V(± 10%)
Power	5W/7W/10W/12W/15W/18W/20W
BEAM ANGLE	15° /24° /36° /50° ±3°
RENDERING INDEX (Ra)	>80Ra or 90Ra
Material Quality	Aluminum
Color Temperature	Warm White(2700K/3000K/3500K) / Natural White(4000K) / Cool white(5000K/6000K)
Efficiency	85-90lm/w±10% for non-dimmable model; 80-85lm/w±10% for dimmable model;
OPTICS	Floating Light Lens
HEATSINK	Machined pure aluminum with anodize finish
Installation	Recessed/Embedded
BASE TYPE	External Driver
DIMMABILITY	Dimmable(0-10V /Triac /Dali) and Tuya Smart Dimming/ or Non-dimmable Model
Key Feature 1	Aluminum Cob Anti-glare Floating Beam Spotlight
Key Feature 2	Hotel / Residential Living Room Led Spotlight
Certification	CE/EMC/LVD/ROHS/SAA(Whole lamp);Driver(CE/EMC/LVD/ROHS/CB/SAA/UL)

ENVIRONMENTAL SPECIFICATIONS

TEMPERATURE RANGE	Ambient: -20°C to 40°C; Surface of Lamp: 60°C to 70°C
HUMIDITY RANGE	0 to 95% non-condensing humidity

PRODUCT CODE: FT-HGS17-X₁/X₂

X1: Power

X2: LED chip(OSRAM / Cree or Epistar / bridgelux)

Dongguan Fitlight Lighting Co.,Ltd.

Add: 10th floor, building C1, Songhu Zhigu building, No. 9, Yanhe South Road, Liaobu Town, Dongguan City, Guangdong Province, China.

Email : liu@fitlight-tech.com URL: www.fitlight-tech.com / <https://fitlight.en.alibaba.com>



										
2700-6000k	0.5/0.95	>90 or >80	IP20	50000hours	IK07	Flicker Free	5 Years Warranty	CE	Dimmable (optional)	

Dongguan Fitlight Lighting Co.,Ltd.

Add: 10th floor, building C1, Songhu Zhigu building, No. 9, Yanhe South Road, Liaobu Town, Dongguan City, Guangdong Province, China.

Email : liu@fitlight-tech.com URL: www.fitlight-tech.com / <https://fitlight.en.alibaba.com>

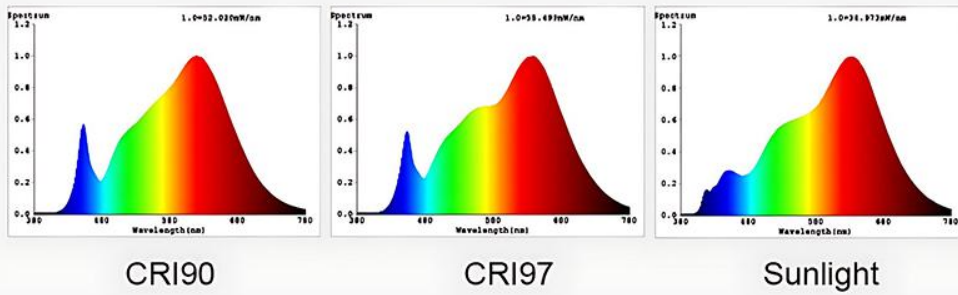

CCT option



Material Brand Cooperation

PHILIPS

CREE

OSRAM

EAGLE RISE

LIFUD

bridgelux

powered by
TRIDONIC

LUMINUS

EPISTAR

EOKE

KR
KERUI GROUP

CITILED®
The Light Engine

COB brand



Other brands are also available

Power brand



Five-year warranty, no flicker PF > 0.9

Dongguan Fitlight Lighting Co.,Ltd.

Add: 10th floor, building C1, Songhu Zhigu building, No. 9, Yanhe South Road, Liaobu Town, Dongguan City, Guangdong Province, China.

Email : liu@fitlight-tech.com URL: www.fitlight-tech.com / <https://fitlight.en.alibaba.com>



MODEL	POWER	CUTOUT	SIZE	CRI	COLOR TEMPERATURE	WORKING VOLTAGE
FT-HGS17-5W	5W	55	D65*H66	≥90	2700K	AC 200-240V
FT-HGS17-7W	7W	55	D65*H66		3000K	
FT-HGS17-10W	10W	75	D85*H76		3500K	
FT-HGS17-12W	12W	75	D85*H76		4000K	or AC 100-240V
FT-HGS17-15W	15W	75	D85*H76		5000K	
FT-HGS17-18W	18W	95	D105*H95		6000K	
FT-HGS17-20W	20W	95	D105*H95			



Dongguan Fitlight Lighting Co.,Ltd.









Add: 10th floor, building C1, Songhu Zhigu building, No. 9, Yanhe South Road, Liaobu Town, Dongguan City, Guangdong Province, China.

Email : liu@fitlight-tech.com URL: www.fitlight-tech.com / <https://fitlight.en.alibaba.com>

For a 75mm opening, you can also choose a curved front ring. The lamp body looks like a frameless design, integrating perfectly with the ceiling. In addition, the shell color offers the following options: Deep Bay Blue, Elegant Gray, Olive Green, Magenta, Dawn Gold, Lava Orange, Rock Gray, Rosy Purple, Titanium Gray, and Star Gray.



MODEL	POWER	CUTOUT	SIZE	CRI	COLOR TEMPERATURE	WORKING VOLTAGE
FT-HGS17-10W	10W	75	D85*H76	≥90	2700K	AC 200-240V or AC 100-240V
FT-HGS17-12W	12W	75	D85*H76		3000K	
FT-HGS17-15W	15W	75	D85*H76		3500K 4000K 5000K 6000K	

Dongguan Fitlight Lighting Co.,Ltd.

Add: 10th floor, building C1, Songhu Zhigu building, No. 9, Yanhe South Road, Liaobu Town, Dongguan City, Guangdong Province, China.

Email : liu@fitlight-tech.com URL: www.fitlight-tech.com / <https://fitlight.en.alibaba.com>

Two anti - glare cover styles, multiple colors Adapt to various decorative styles

[Anti - glare cover colors]

Natural White | Natural Black | Gun Black | Matte Silver

Bright Silver | Matte Black | Matte White | Rose Gold

Champagne Gold



Dongguan Fitlight Lighting Co.,Ltd.

Add: 10th floor, building C1, Songhu Zhigu building, No. 9, Yanhe South Road, Liaobu Town, Dongguan City, Guangdong Province, China.

Email : liu@fitlight-tech.com URL: www.fitlight-tech.com / <https://fitlight.en.alibaba.com>

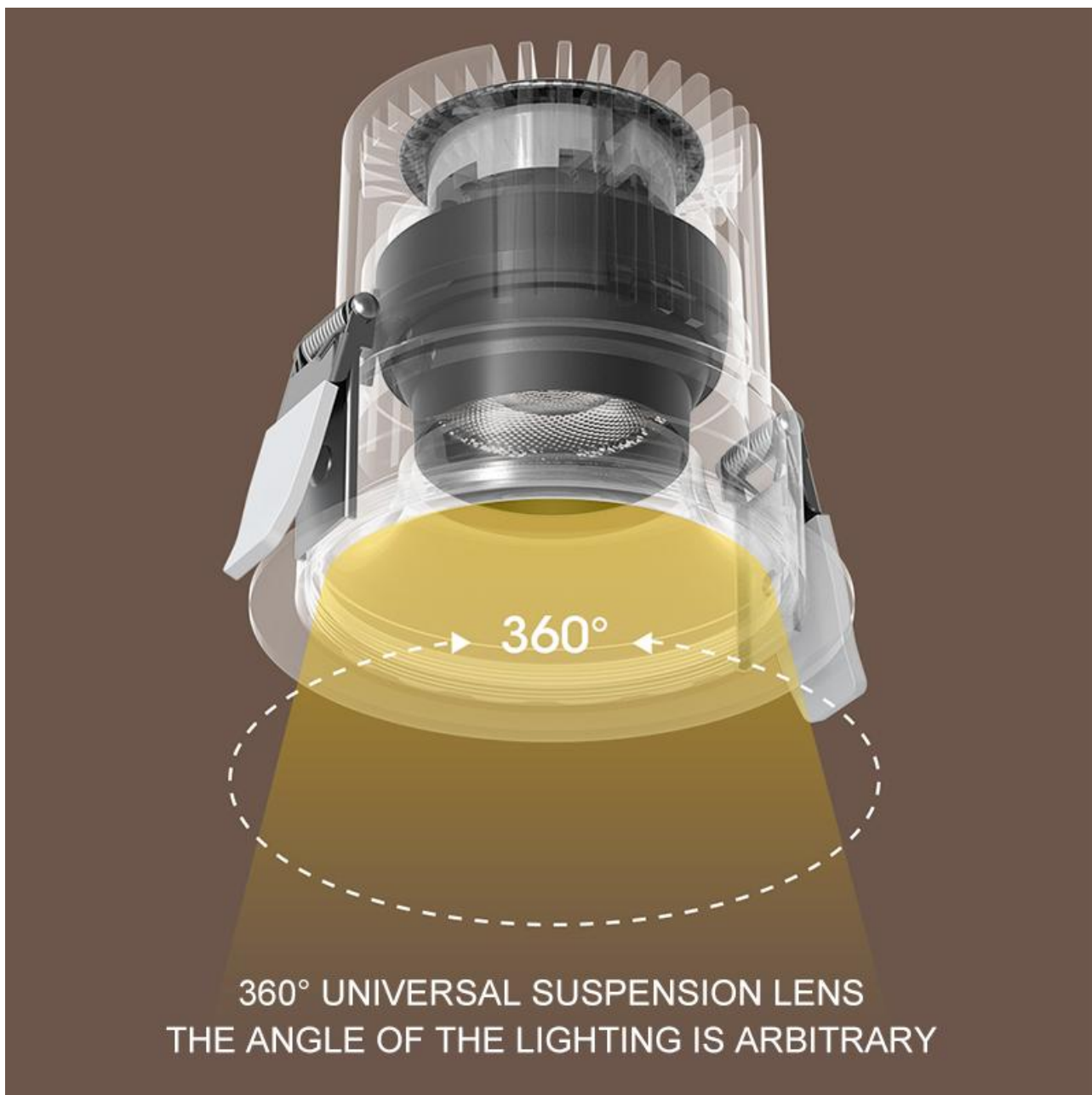

Dongguan Fitlight Lighting Co.,Ltd.

Add: 10th floor, building C1, Songhu Zhigu building, No. 9, Yanhe South Road, Liaobu Town, Dongguan City, Guangdong Province, China.

Email : liu@fitlight-tech.com URL: www.fitlight-tech.com / <https://fitlight.en.alibaba.com>



Dongguan Fitlight Lighting Co.,Ltd.

Add: 10th floor, building C1, Songhu Zhigu building, No. 9, Yanhe South Road, Liaobu Town, Dongguan City, Guangdong Province, China.

Email : liu@fitlight-tech.com URL: www.fitlight-tech.com / <https://fitlight.en.alibaba.com>



**HIGH-QUALITY ALUMINUM LAMP BODY
WITH FAST HEAT DISSIPATION AND LONG LIFESPAN**

Dongguan Fitlight Lighting Co.,Ltd.

Add: 10th floor, building C1, Songhu Zhigu building, No. 9, Yanhe South Road, Liaobu Town, Dongguan City, Guangdong Province, China.

Email : liu@fitlight-tech.com URL: www.fitlight-tech.com / <https://fitlight.en.alibaba.com>

High Color Rendering Index Realistic Presentation of Native Colors

High color rendering can fully restore the true colors of objects. Generally, a Ra (Color Rendering Index) of ≥ 85 can be considered excellent color rendering performance. The larger the Ra value, the better the color rendering performance; conversely, the smaller the Ra value, the poorer the color rendering performance.



Ra ≥ 90 performs better in color rendering: High color restoration, colors close to natural hues.

Color Rendering Index Ra ≤ 80 : Colors are obviously distorted, and color saturation is low.

Dongguan Fitlight Lighting Co.,Ltd.

Add: 10th floor, building C1, Songhu Zhigu building, No. 9, Yanhe South Road, Liaobu Town, Dongguan City, Guangdong Province, China.

Email : liu@fitlight-tech.com URL: www.fitlight-tech.com / <https://fitlight.en.alibaba.com>

Product Size

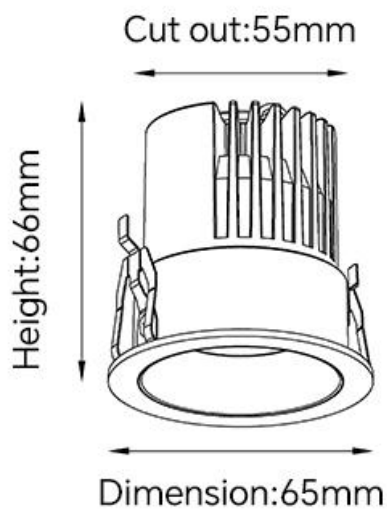

5W/7W

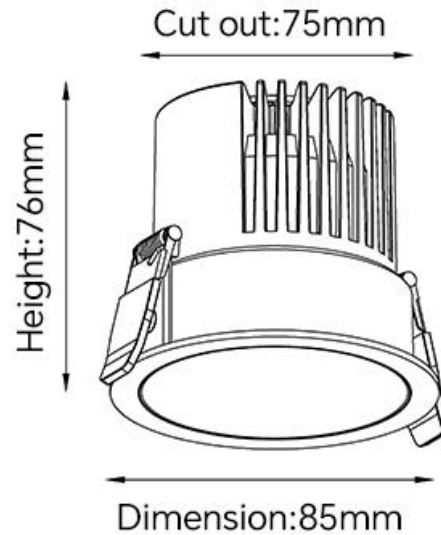

10W/12W/15W

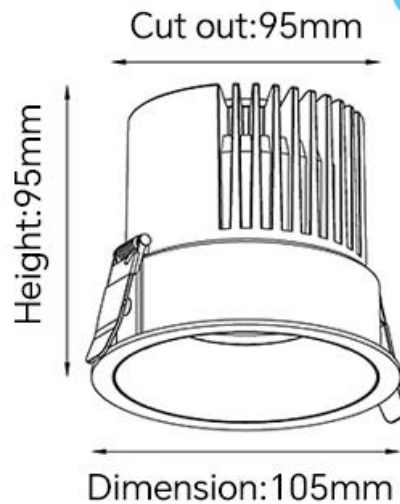

18W/20W

Dongguan Fitlight Lighting Co.,Ltd.

Add: 10th floor, building C1, Songhu Zhigu building, No. 9, Yanhe South Road, Liaobu Town, Dongguan City, Guangdong Province, China.

Email : liu@fitlight-tech.com URL: www.fitlight-tech.com / <https://fitlight.en.alibaba.com>

DIMMABLE

Single color dimmable



TRIAC



0-10V



DALI

2700-6000K tunable



2.4G

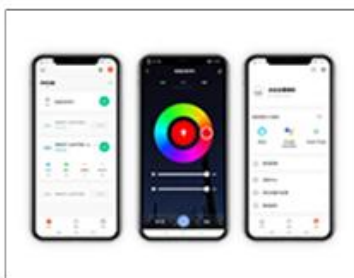

TUYA
(Bluetooth WiFi ZIGBEE)



DALI DT8

Dongguan Fitlight Lighting Co.,Ltd.

Add: 10th floor, building C1, Songhu Zhigu building, No. 9, Yanhe South Road, Liaobu Town, Dongguan City, Guangdong Province, China.

Email : liu@fitlight-tech.com URL: www.fitlight-tech.com / <https://fitlight.en.alibaba.com>

Intelligent Dimming And CCT Adjustment

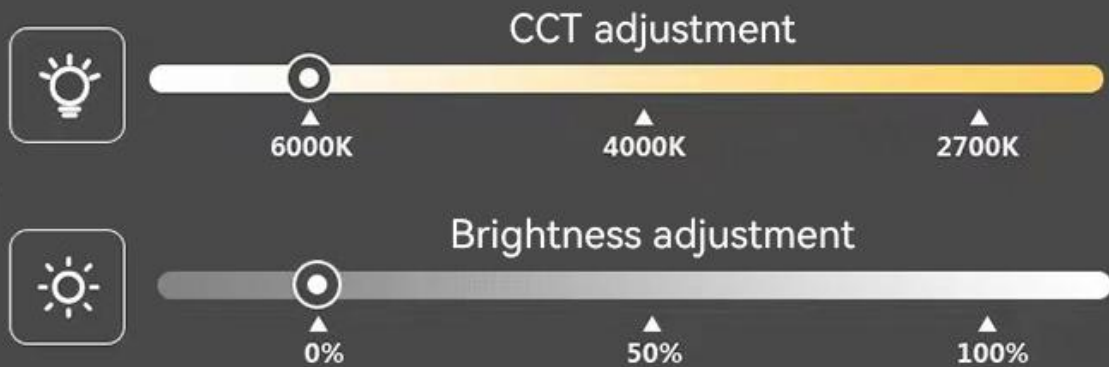

LED Down light Model at Ta=25°

Parameter	Symbol	Min	Type	Max	Unit
Input Voltage (AC)	V _{AC}	165	230	265	V
Estimated Life[*]		—	50,000	—	hours
Optimized Body Temperature	T	—	55	60	°C

Note[*] – Manufacturer projects Down Light made with COB LED to maintain an average of 70% lumens maintenance after 30,000 hours. This estimation is made based on data from LED manufacturer

Dongguan Fitlight Lighting Co.,Ltd.

Add: 10th floor, building C1, Songhu Zhigu building, No. 9, Yanhe South Road, Liaobu Town, Dongguan City, Guangdong Province, China.

Email : liu@fitlight-tech.com URL: www.fitlight-tech.com / <https://fitlight.en.alibaba.com>

Installation of Light with springs:

The installation method can be installed according to the installation diagram of the luminaire. The installation position of the luminaire is selected by the embedded installation, and the hanging parts, cables, installation tools, etc. required for installation are prepared. The luminaires are led out according to relevant specifications, and the luminaires are hanged by hanging parts, etc. The back cover is pre-selected and properly hung or embedded to the pre-selected position.

Installation Instructions

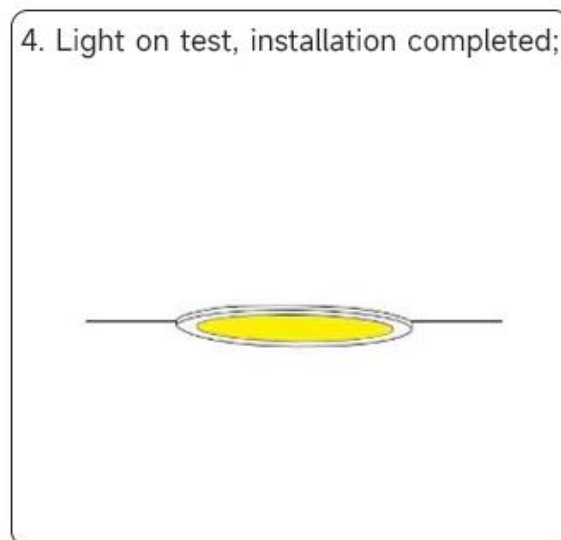
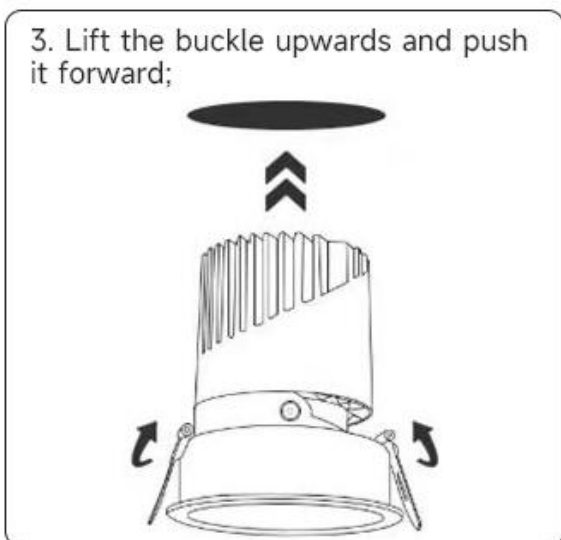

The front-end power supply must be cut off during installation. The power supply must be cut off when repairing or replacing parts.

Dongguan Fitlight Lighting Co.,Ltd.

Add: 10th floor, building C1, Songhu Zhigu building, No. 9, Yanhe South Road, Liaobu Town, Dongguan City, Guangdong Province, China.

Email : liu@fitlight-tech.com URL: www.fitlight-tech.com / <https://fitlight.en.alibaba.com>

INSTALL APPLICATION

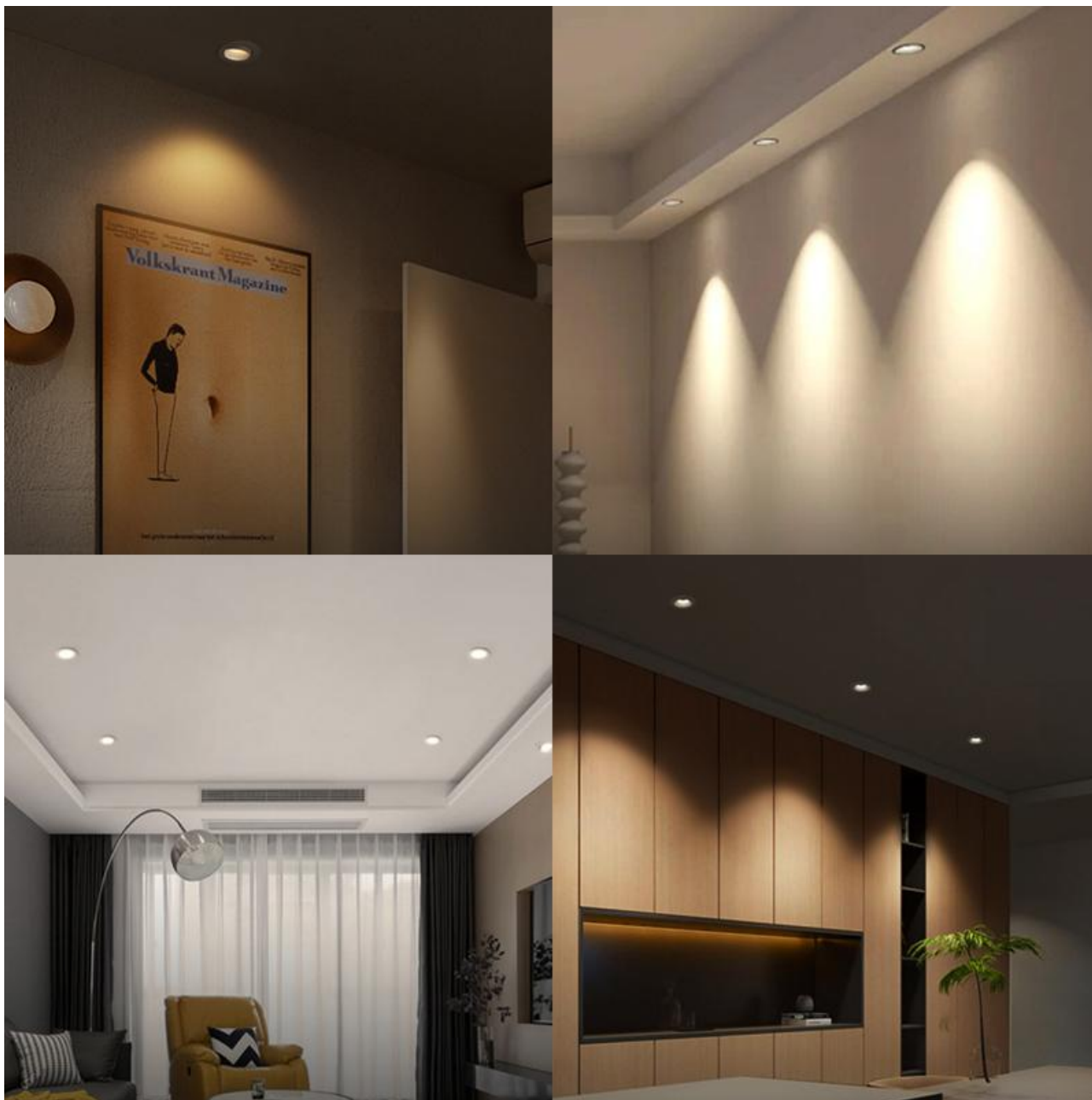

Dongguan Fitlight Lighting Co.,Ltd.

Add: 10th floor, building C1, Songhu Zhigu building, No. 9, Yanhe South Road, Liaobu Town, Dongguan City, Guangdong Province, China.

Email : liu@fitlight-tech.com URL: www.fitlight-tech.com / <https://fitlight.en.alibaba.com>

Standard Export packaging



Caution:

- WARNING-Risk of fire or electric shock. LED Down light installation requires knowledge of luminaire electrical systems.
- If not qualified, do not attempt installation. Contact a qualified electrician.
- WARNING-To prevent wiring damage or abrasion, do not expose wiring to edges of sheet ; metal or other sharp objects.

Hygiene & Safety

- Provide the illumination required in the work area for moving parts.
- We advise to use the soft cloth to clean up and do not attempt to use any chemical agent.
- In order to avoid any damages from the surface.
- Minimize the accumulation of dirt on the lamps and spotlights;
- For your safety, please cut off the power supply before changing or cleaning the lamp source.
- Facilitate maintenance.

Dongguan Fitlight Lighting Co.,Ltd.

Add: 10th floor, building C1, Songhu Zhigu building, No. 9, Yanhe South Road, Liaobu Town, Dongguan City, Guangdong Province, China.

Email : liu@fitlight-tech.com URL: www.fitlight-tech.com / <https://fitlight.en.alibaba.com>