



**OEM/ODM**  
**Professional Lighting Product Manufacturer**

1. 14+ Years of Industry Leadership
2. Full Customization (OEM/ODM)
3. Certified Excellence: Globally recognized certifications (CE, RoHS, SAA, etc.)
4. Energy-Efficient & Sustainable Solutions
5. Competitive Pricing & Fast Turnaround
6. Dedicated R&D & Continuous Innovation

**14**<sup>+years</sup>  
Production experience

**3000**<sup>+m<sup>2</sup></sup>  
Factory space

**50**<sup>+</sup>  
Patent certificate

**100**<sup>+</sup>  
Projects

**10000**<sup>+pcs</sup>  
Daily output value

**100**<sup>+</sup>  
Service country



Dongguan Fitlight Lighting Co.,Ltd.

Add: 10th floor, building C1, Songhu Zhigu building, No. 9, Yanhe South Road, Liaobu Town, Dongguan City, Guangdong Province, China.

Email : [liu@fitlight-tech.com](mailto:liu@fitlight-tech.com) URL: [www.fitlight-tech.com](http://www.fitlight-tech.com) / <https://fitlight.en.alibaba.com>

## Features and Benefits

- Light source: OSRAM COB LED
- Long LED life: More than 50,000 hours
- Low heat, less than 60°C
- No UV or IR light radiation
- No mercury or other inorganic
- Homogeneous flood illumination
- Machined aluminum heat fins with excellent thermal efficiencies
- The LED magnetic lamps are available in the following white color temperatures:  
3000/4000/6000K
- 2 years limited warranty
- 48V safety voltage, the light can be moved manual, no contact hazard



## Typical Applications

- Spot lighting
- Retail Store lighting
- Commercial lighting
- Residential lighting
- General lighting
- Energy Saving Programs
- Sustainable Energy

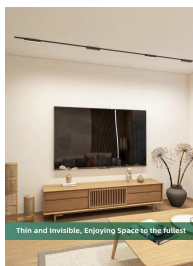

Magnetic Grill Light



Magnetic Track Light



Magnetic Folding Grille Light



Magnetic Grille Light

Dongguan Fitlight Lighting Co.,Ltd.

Add: 10th floor, building C1, Songhu Zhigu building, No. 9, Yanhe South Road, Liaobu Town, Dongguan City, Guangdong Province, China.

Email : [liu@fitlight-tech.com](mailto:liu@fitlight-tech.com) URL: [www.fitlight-tech.com](http://www.fitlight-tech.com) / <https://fitlight.en.alibaba.com>

## PRODUCT SPECIFICATIONS

<b>LAMP TYPE</b>	Magnetic Lamps Series
<b>LIGHT SOURCE</b>	OSRAM COB LED
<b>VARIOUS STYLES PROVIDED</b>	Multiple magnetic suction series lamps can be combined and matched (1) Magnetic Folding Grille Light (2) Magnetic Grille Light (3) Magnetic Track Light (4) Magnetic Flood Light (5) Magnetic Pendant Light
<b>RENDERING INDEX (Ra)</b>	>90Ra
<b>Color Temperature</b>	3000/4000/6000K
<b>Efficiency</b>	50lm/w
<b>OPTICS</b>	Aluminum coating lens
<b>HEATSINK</b>	Machined pure aluminum with anodize finish
<b>BASE TYPE</b>	Internal Driver,48V Low Safety Voltage
<b>CONTROL</b>	Tuya (Bluetooth/Zigbee )



Dongguan Fitlight Lighting Co.,Ltd.

Add: 10th floor, building C1, Songhu Zhigu building, No. 9, Yanhe South Road, Liaobu Town, Dongguan City, Guangdong Province, China.

Email : [liu@fitlight-tech.com](mailto:liu@fitlight-tech.com) URL: [www.fitlight-tech.com](http://www.fitlight-tech.com) / <https://fitlight.en.alibaba.com>

VARIOUS STYLES PROVIDED

### 48V Ultra-Thin Magnetic Track Light

No ceiling, no slotting, easy to install

Surface mounted track

iPhone

Strong magnetic sucker

High CRI 90

48V low voltage

No flicker

Dongguan Fitlight Lighting Co.,Ltd.

Add: 10th floor, building C1, Songhu Zhigu building, No. 9, Yanhe South Road, Liaobu Town, Dongguan City, Guangdong Province, China.

Email : [liu@fitlight-tech.com](mailto:liu@fitlight-tech.com) URL: [www.fitlight-tech.com](http://www.fitlight-tech.com) / <https://fitlight.en.alibaba.com>

**Breaking through thin boundaries**



**Fearless of low levels**

**High release repressed space**



Brand new exquisite and slim track design,  
say goodbye to heaviness.



Dongguan Fitlight Lighting Co.,Ltd.

Add: 10th floor, building C1, Songhu Zhigu building, No. 9, Yanhe South Road, Liaobu Town, Dongguan City, Guangdong Province, China.

Email : [liu@fitlight-tech.com](mailto:liu@fitlight-tech.com) URL: [www.fitlight-tech.com](http://www.fitlight-tech.com) / <https://fitlight.en.alibaba.com>



Dongguan Fitlight Lighting Co.,Ltd.

Add: 10th floor, building C1, Songhu Zhigu building, No. 9, Yanhe South Road, Liaobu Town, Dongguan City, Guangdong Province, China.

Email : [liu@fitlight-tech.com](mailto:liu@fitlight-tech.com) URL: [www.fitlight-tech.com](http://www.fitlight-tech.com) / <https://fitlight.en.alibaba.com>

## 48V LOW VOLTAGE

## MAGNETIC TRACK LIGHT

- Smart control, 5 years warranty
- High CRI90/97, Flicker Free
- Sleek, compact design and simple operation

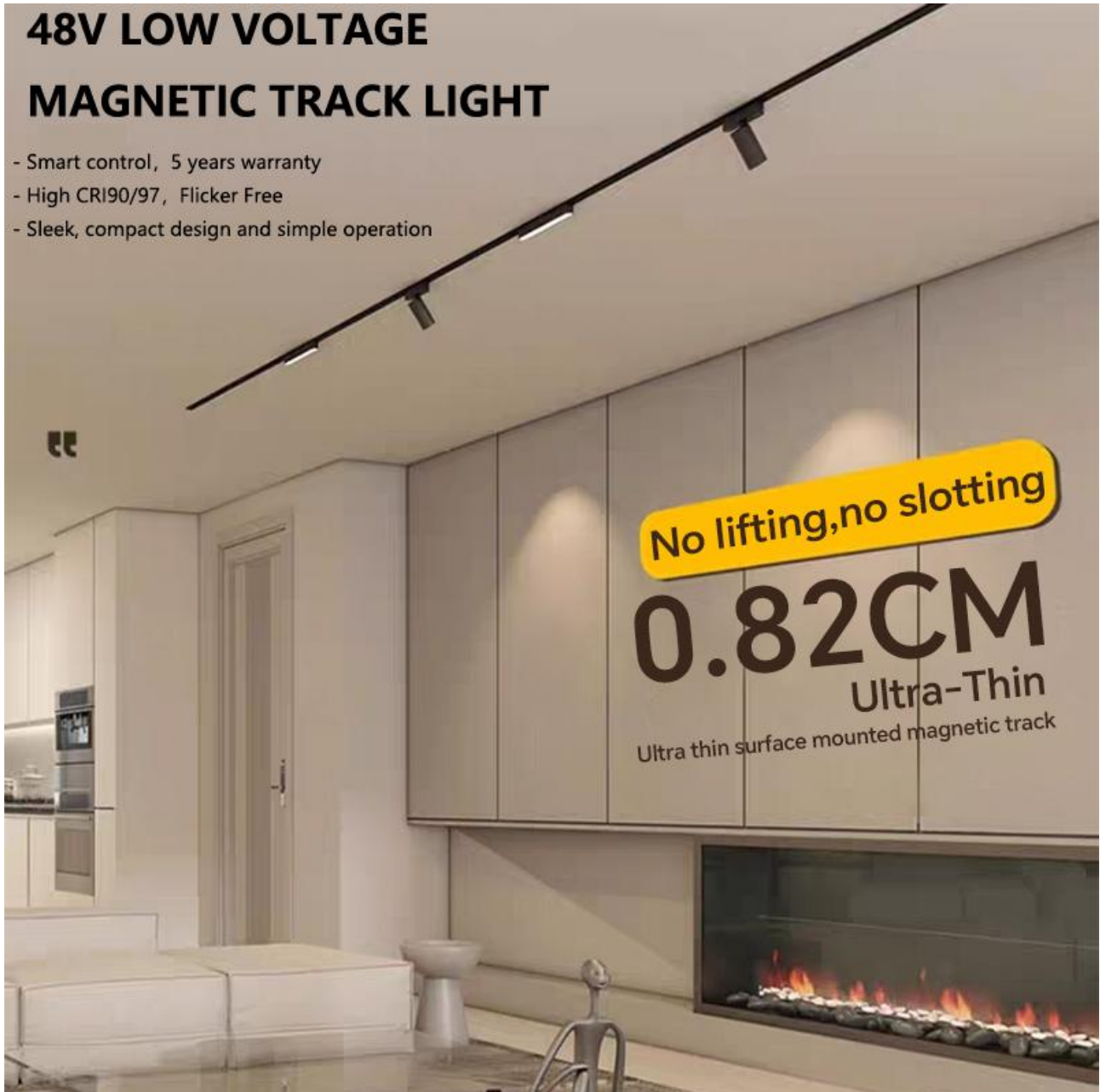

Dongguan Fitlight Lighting Co.,Ltd.

Add: 10th floor, building C1, Songhu Zhigu building, No. 9, Yanhe South Road, Liaobu Town, Dongguan City, Guangdong Province, China.

Email : [liu@fitlight-tech.com](mailto:liu@fitlight-tech.com) URL: [www.fitlight-tech.com](http://www.fitlight-tech.com) / <https://fitlight.en.alibaba.com>

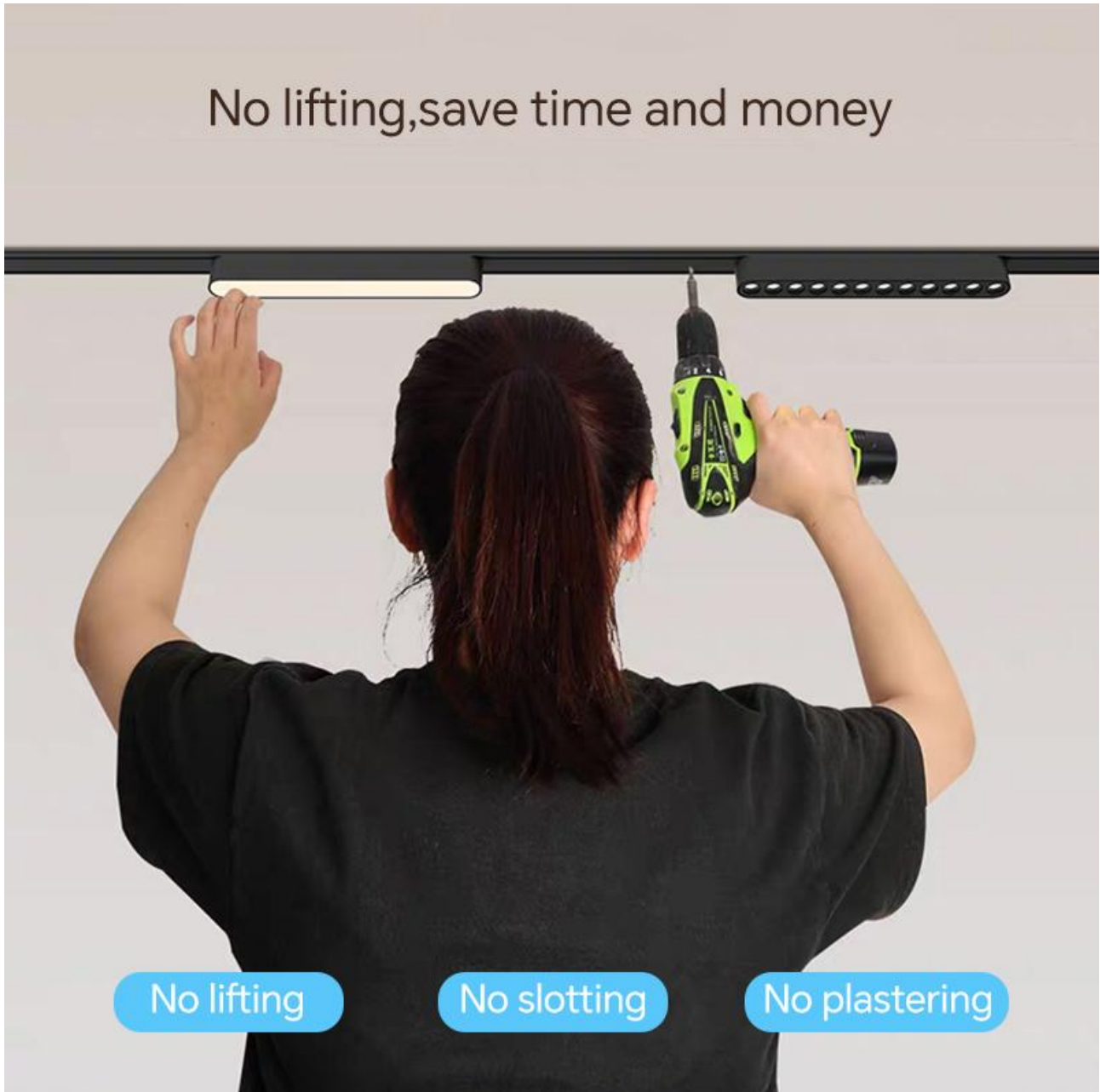

Dongguan Fitlight Lighting Co.,Ltd.

Add: 10th floor, building C1, Songhu Zhigu building, No. 9, Yanhe South Road, Liaobu Town, Dongguan City, Guangdong Province, China.

Email : [liu@fitlight-tech.com](mailto:liu@fitlight-tech.com) URL: [www.fitlight-tech.com](http://www.fitlight-tech.com) / <https://fitlight.en.alibaba.com>

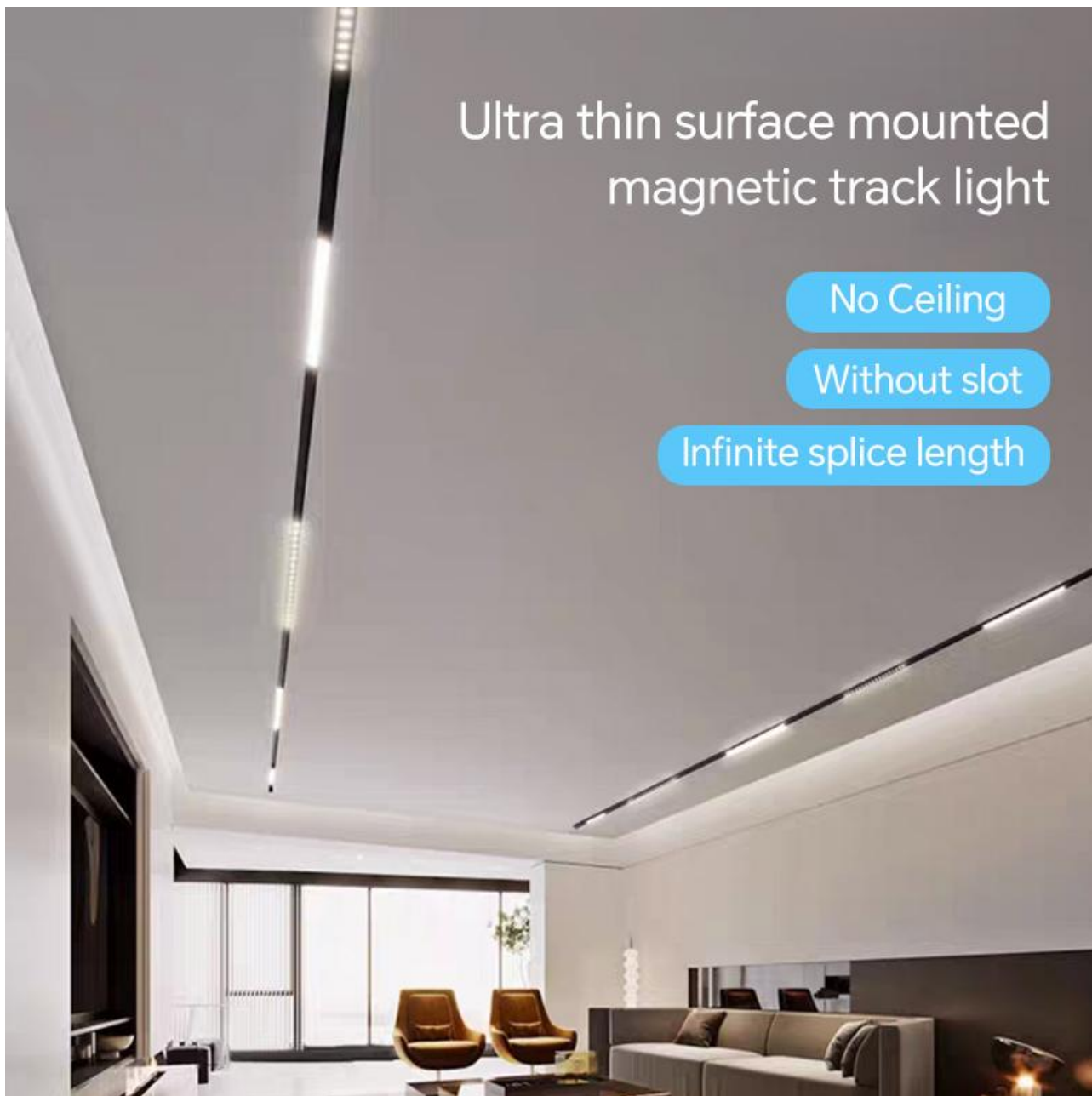

Dongguan Fitlight Lighting Co.,Ltd.

Add: 10th floor, building C1, Songhu Zhigu building, No. 9, Yanhe South Road, Liaobu Town, Dongguan City, Guangdong Province, China.

Email : [liu@fitlight-tech.com](mailto:liu@fitlight-tech.com) URL: [www.fitlight-tech.com](http://www.fitlight-tech.com) / <https://fitlight.en.alibaba.com>

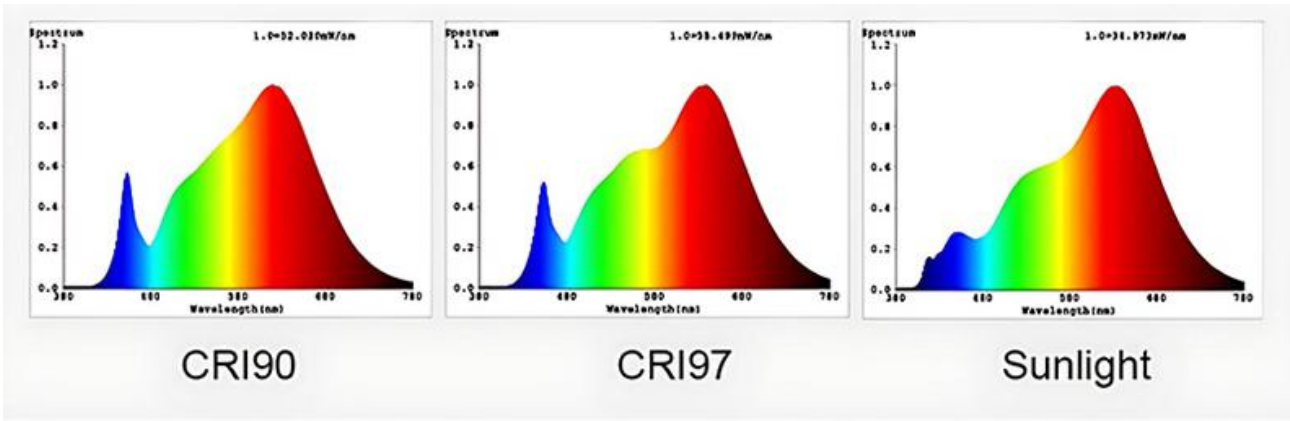

### CCT option



### Smart control

3000K-6000K tunable Zigbee/Bluetooth/Casambi



3000K-6000K

Dongguan Fitlight Lighting Co.,Ltd.

Add: 10th floor, building C1, Songhu Zhigu building, No. 9, Yanhe South Road, Liaobu Town, Dongguan City, Guangdong Province, China.

Email : [liu@fitlight-tech.com](mailto:liu@fitlight-tech.com) URL: [www.fitlight-tech.com](http://www.fitlight-tech.com) / <https://fitlight.en.alibaba.com>

### Connection application diagram

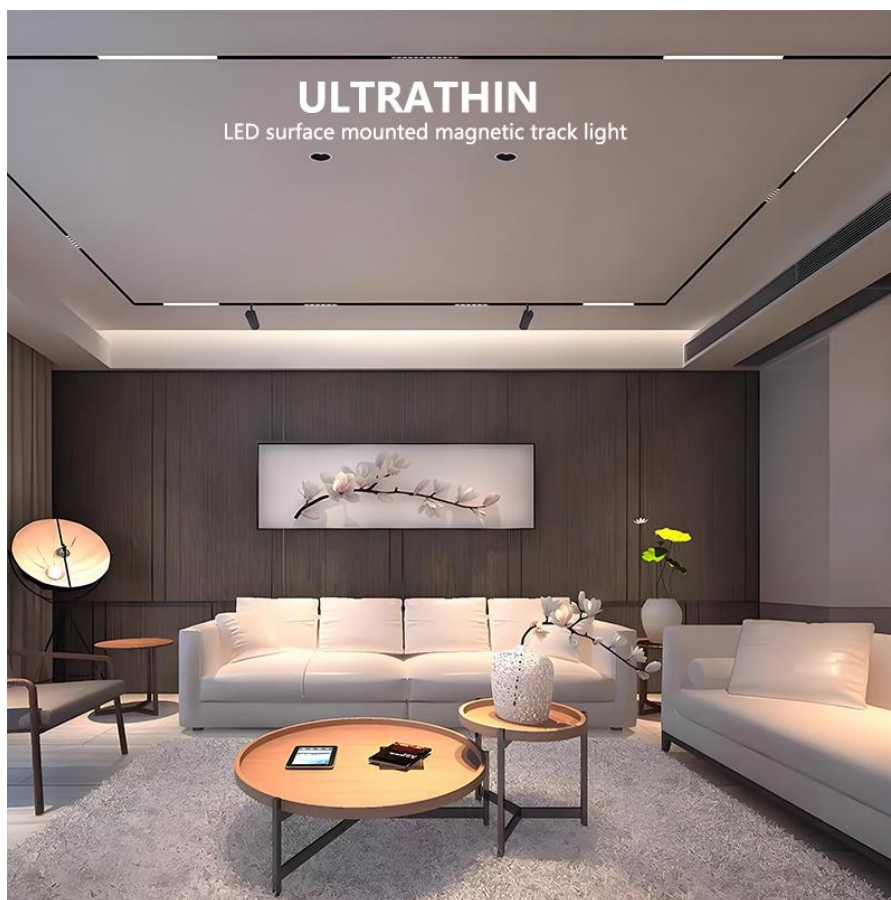

Dongguan Fitlight Lighting Co.,Ltd.

Add: 10th floor, building C1, Songhu Zhigu building, No. 9, Yanhe South Road, Liaobu Town, Dongguan City, Guangdong Province, China.

Email : [liu@fitlight-tech.com](mailto:liu@fitlight-tech.com) URL: [www.fitlight-tech.com](http://www.fitlight-tech.com) / <https://fitlight.en.alibaba.com>

ULTRA THIN

### Smart light

My Home APP switches multiple scene modes



Moonlight Mode

Soft light for good sleep

CCT3000k

Brightness10%



Activity Mode

Atmosphere Free

CCT4000k

Brightness80%



Learning Mode

Focused and Concentrated

CCT6000k

Brightness100%

Dongguan Fitlight Lighting Co.,Ltd.

Add: 10th floor, building C1, Songhu Zhigu building, No. 9, Yanhe South Road, Liaobu Town, Dongguan City, Guangdong Province, China.

Email : [liu@fitlight-tech.com](mailto:liu@fitlight-tech.com) URL: [www.fitlight-tech.com](http://www.fitlight-tech.com) / <https://fitlight.en.alibaba.com>

MAGNETIC LAMP PARAMETERS			
Product display	name	power	Product size
	Track rail		1m 2m 3m
	Magnetic Flood Light	6W 12W 18W	L121*W25.6*H30.5mm L237*W25.6*H30.5mm L353*W25.6*H30.5mm
	Magnetic Grille Light	6W 12W 18W	L121*W25.6*H30.5mm L237*W25.6*H30.5mm L353*W25.6*H30.5mm
	Magnetic Folding Grille Light	6W 12W 18W	L127*W33.6*H59.2mm L235.5*W33.6*H59.5mm L343*W33.6*H59.2mm
	Magnetic Track Light	6W 10W 18W 20W	D35*H80mm D45*H100mm D55*H109mm D65*H120mm
	Driver	100w 200w	300*25*30mm

Dongguan Fitlight Lighting Co.,Ltd.

Add: 10th floor, building C1, Songhu Zhigu building, No. 9, Yanhe South Road, Liaobu Town, Dongguan City, Guangdong Province, China.

Email : [liu@fitlight-tech.com](mailto:liu@fitlight-tech.com) URL: [www.fitlight-tech.com](http://www.fitlight-tech.com) / <https://fitlight.en.alibaba.com>

MAGNETIC LAMP PARAMETERS			
Product display	name	power	Product size
	Magnetic Pendant Light	6W 10W 12W	φ30*L300mm φ40*L300mm φ60*L300mm
	Circle Complementary Lighting	15W	96*127*128mm
	Circular Spotlight	15W	96*127*128mm
	Square Spotlight	15W	76*115*128mm
	Rectangular Spotlight	24W	220*85*128mm
	Magnetic Downlight	8W	54*64*68mm

Dongguan Fitlight Lighting Co.,Ltd.

Add: 10th floor, building C1, Songhu Zhigu building, No. 9, Yanhe South Road, Liaobu Town, Dongguan City, Guangdong Province, China.

Email : [liu@fitlight-tech.com](mailto:liu@fitlight-tech.com) URL: [www.fitlight-tech.com](http://www.fitlight-tech.com) / <https://fitlight.en.alibaba.com>

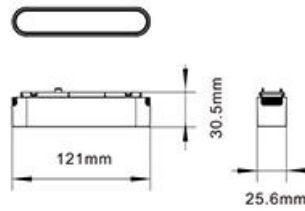

6W Magnetic Flood Light

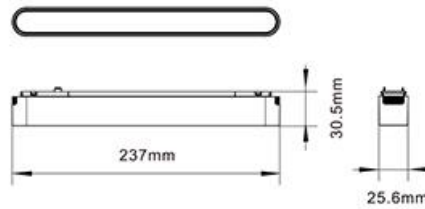

12W Magnetic Flood Light

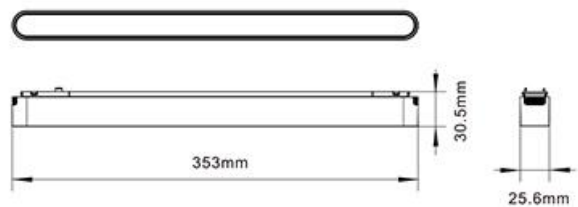

18W Magnetic Flood Light



Power: 6W/12W/18W	CCT: 3000K/4000K/6000K
Driver: 48V	LED Chip: OSRAM , CRI > 90
Beam Angle: 120°	Material: Aluminum

Dongguan Fitlight Lighting Co.,Ltd.

Add: 10th floor, building C1, Songhu Zhigu building, No. 9, Yanhe South Road, Liaobu Town, Dongguan City, Guangdong Province, China.

Email : [liu@fitlight-tech.com](mailto:liu@fitlight-tech.com) URL: [www.fitlight-tech.com](http://www.fitlight-tech.com) / <https://fitlight.en.alibaba.com>



6W Magnetic Grille Light

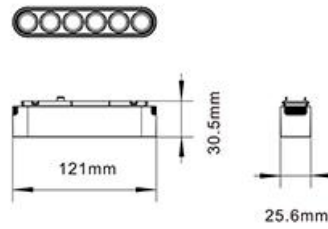

12W Magnetic Grille Light

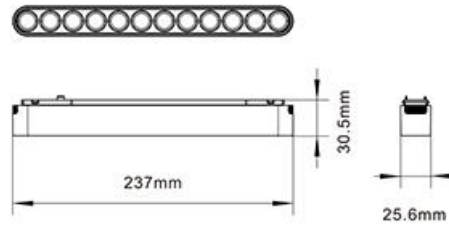

18W Magnetic Grille Light

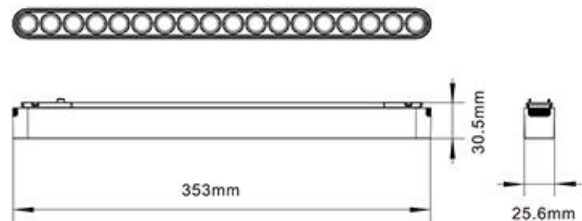

Power: 6W/12W/18W	CCT: 3000K/4000K/6000K
Driver: 48V	LED Chip: OSRAM , CRI > 90
Beam Angle: 24°	Material: Aluminum

Dongguan Fitlight Lighting Co.,Ltd.

Add: 10th floor, building C1, Songhu Zhigu building, No. 9, Yanhe South Road, Liaobu Town, Dongguan City, Guangdong Province, China.

Email : [liu@fitlight-tech.com](mailto:liu@fitlight-tech.com) URL: [www.fitlight-tech.com](http://www.fitlight-tech.com) / <https://fitlight.en.alibaba.com>

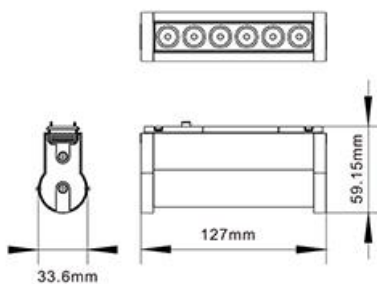

6W Magnetic Folding Grille Light

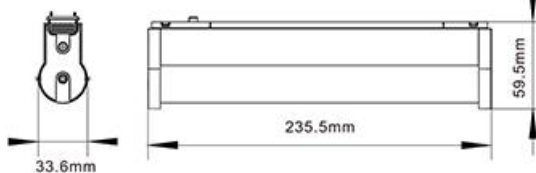

12W Magnetic Folding Grille Light

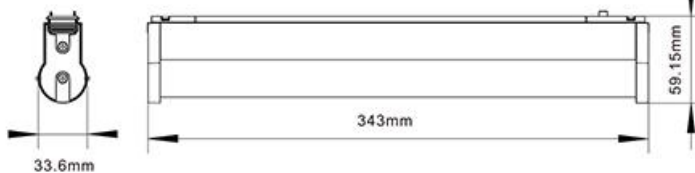

18W Magnetic Folding Grille Light



Power: 6W/12W/18W	CCT: 3000K/4000K/6000K
Driver: 48V	LED Chip: OSRAM , CRI > 90
Beam Angle: 24°	Material: Aluminum

Dongguan Fitlight Lighting Co.,Ltd.

Add: 10th floor, building C1, Songhu Zhigu building, No. 9, Yanhe South Road, Liaobu Town, Dongguan City, Guangdong Province, China.

Email : [liu@fitlight-tech.com](mailto:liu@fitlight-tech.com) URL: [www.fitlight-tech.com](http://www.fitlight-tech.com) / <https://fitlight.en.alibaba.com>



8W Magnetic downlight 24°

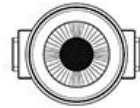
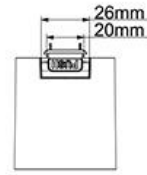
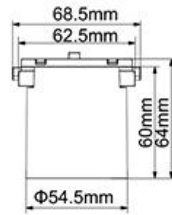

15W circle complementary lighting 120°

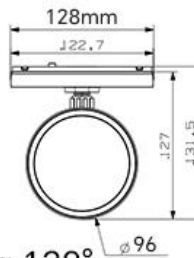

15W Square spotlight 24°

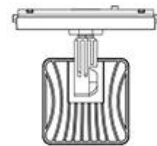
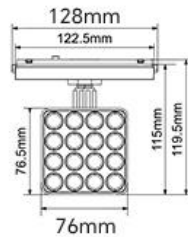

15W Circular spotlight 24°

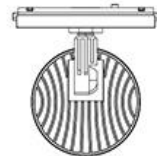
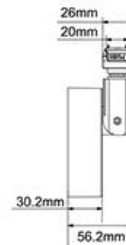
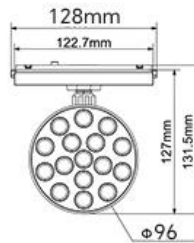

15W Rectangular spotlight 24°

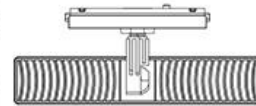
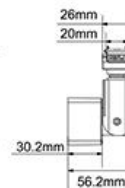
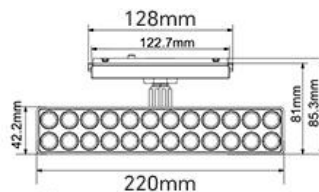

Power: 8W/15W	CCT: 3000K/4000K/6000K
Driver: 48V	LED Chip: OSRAM , CRI > 90
Beam Angle: 24°/ 120°	Material: Aluminum

Dongguan Fitlight Lighting Co.,Ltd.

Add: 10th floor, building C1, Songhu Zhigu building, No. 9, Yanhe South Road, Liaobu Town, Dongguan City, Guangdong Province, China.

Email : [liu@fitlight-tech.com](mailto:liu@fitlight-tech.com) URL: [www.fitlight-tech.com](http://www.fitlight-tech.com) / <https://fitlight.en.alibaba.com>

### Accessories



I Connector



T Connector



L Connector



X Connector



End Cap



Magnetic  
Power Supply



External power  
supply connection  
conductive module



Vertical corner  
connection  
conductive module

Dongguan Fitlight Lighting Co.,Ltd.

Add: 10th floor, building C1, Songhu Zhigu building, No. 9, Yanhe South Road, Liaobu Town, Dongguan City, Guangdong Province, China.

Email : [liu@fitlight-tech.com](mailto:liu@fitlight-tech.com) URL: [www.fitlight-tech.com](http://www.fitlight-tech.com) / <https://fitlight.en.alibaba.com>

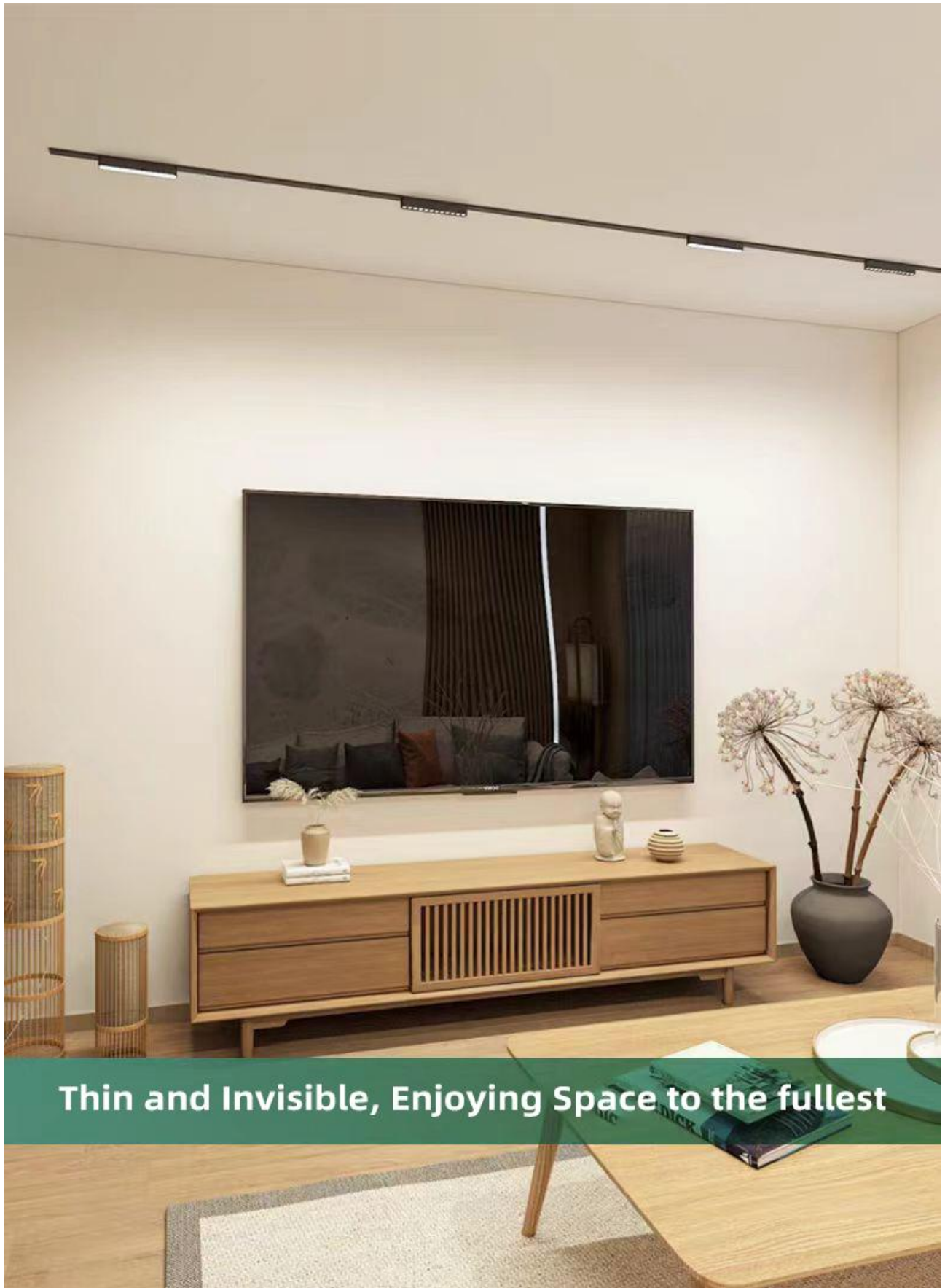

Thin and Invisible, Enjoying Space to the fullest

Dongguan Fitlight Lighting Co.,Ltd.

Add: 10th floor, building C1, Songhu Zhigu building, No. 9, Yanhe South Road, Liaobu Town, Dongguan City, Guangdong Province, China.

Email : [liu@fitlight-tech.com](mailto:liu@fitlight-tech.com) URL: [www.fitlight-tech.com](http://www.fitlight-tech.com) / <https://fitlight.en.alibaba.com>

### Specially designed for the birth of no ceiling Package matching is more worry free

The trend of the era without a main light has fewer limitations

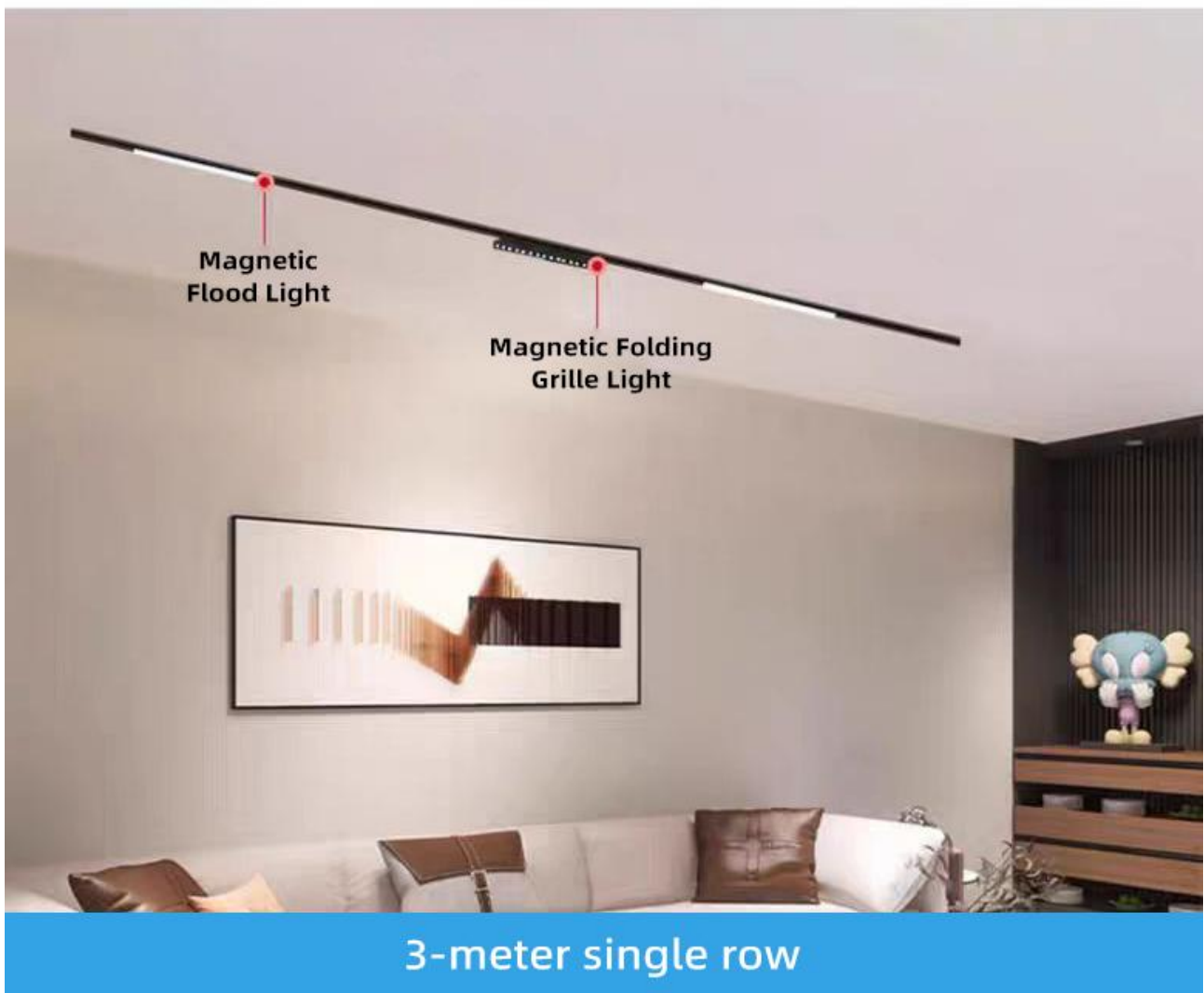

Surface mounted

1pcs

2pcs

1pcs



Track rail 3



Driver 100W



Magnetic Flood Light  
40cm 15W



Magnetic Folding Grille Light  
12W

Dongguan Fitlight Lighting Co.,Ltd.

Add: 10th floor, building C1, Songhu Zhigu building, No. 9, Yanhe South Road, Liaobu Town, Dongguan City, Guangdong Province, China.

Email : [liu@fitlight-tech.com](mailto:liu@fitlight-tech.com) URL: [www.fitlight-tech.com](http://www.fitlight-tech.com) / <https://fitlight.en.alibaba.com>



Surface mounted

2pcs

2pcs

6pcs

4pcs



Dongguan Fitlight Lighting Co.,Ltd.

Add: 10th floor, building C1, Songhu Zhigu building, No. 9, Yanhe South Road, Liaobu Town, Dongguan City, Guangdong Province, China.

Email : [liu@fitlight-tech.com](mailto:liu@fitlight-tech.com) URL: [www.fitlight-tech.com](http://www.fitlight-tech.com) / <https://fitlight.en.alibaba.com>



Surface mounted

1pcs

1pcs

4pcs

2pcs



Dongguan Fitlight Lighting Co.,Ltd.

Add: 10th floor, building C1, Songhu Zhigu building, No. 9, Yanhe South Road, Liaobu Town, Dongguan City, Guangdong Province, China.

Email : [liu@fitlight-tech.com](mailto:liu@fitlight-tech.com) URL: [www.fitlight-tech.com](http://www.fitlight-tech.com) / <https://fitlight.en.alibaba.com>

# Installation steps

## Ultra thin surface mounted track - installation steps

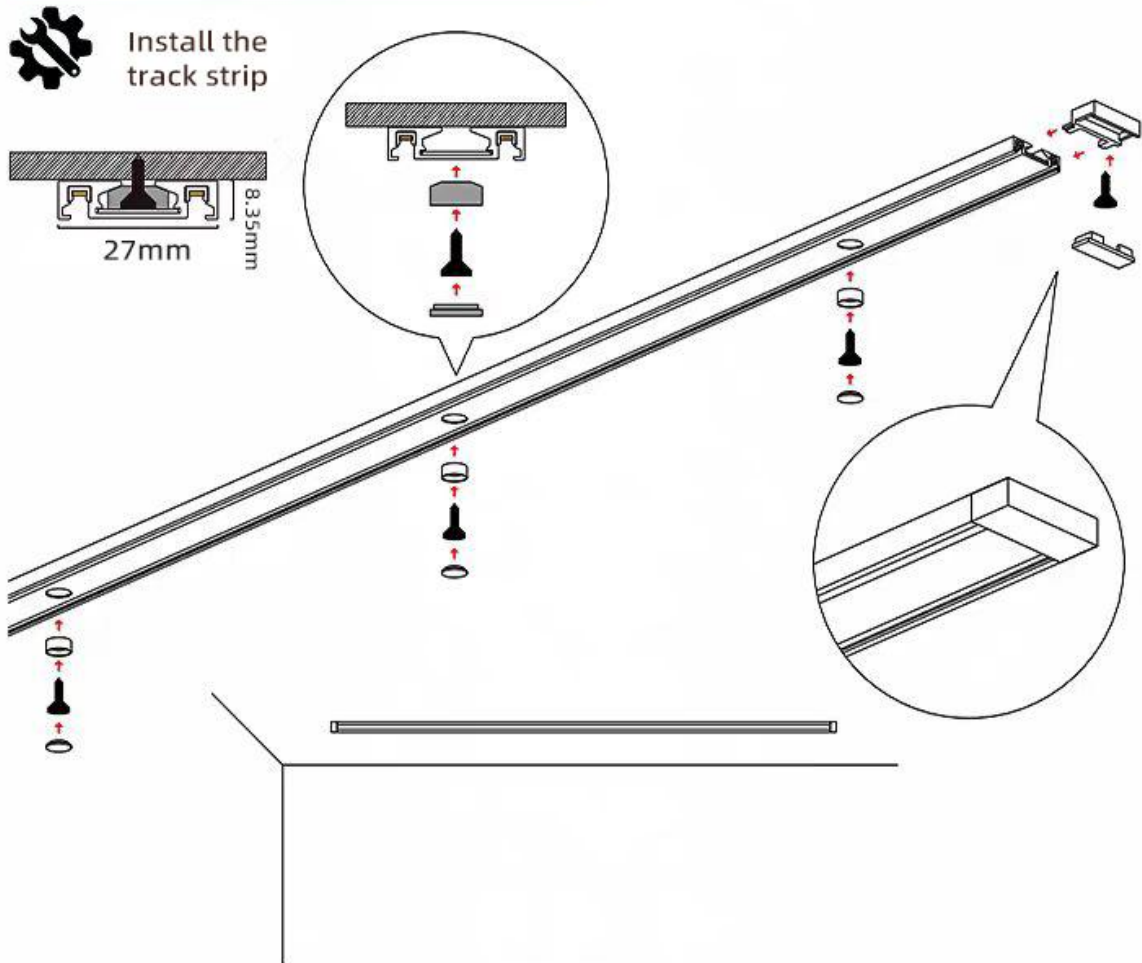

- ① Check if the accessories are complete: ultra-thin surface mounted track strip+ positioning clamp+screws+screw hole cover
- ② According to the planned decoration plan, install the track strip to the ceiling, insert the "positioning plug" into the track strip hole, screw in the screws, and install the "cover" to hide the screw holes
- ③ Screw the three holes every meter of the track until the entire track is fixed to the ceiling;
- ④ Finally, install a plug at the end of the track strip, screw it in, and attach the plug cover. At this point, the installation of the track strip is complete

Dongguan Fitlight Lighting Co.,Ltd.

Add: 10th floor, building C1, Songhu Zhigu building, No. 9, Yanhe South Road, Liaobu Town, Dongguan City, Guangdong Province, China.

Email : [liu@fitlight-tech.com](mailto:liu@fitlight-tech.com) URL: [www.fitlight-tech.com](http://www.fitlight-tech.com) / <https://fitlight.en.alibaba.com>

 Installation steps of lighting fixtures

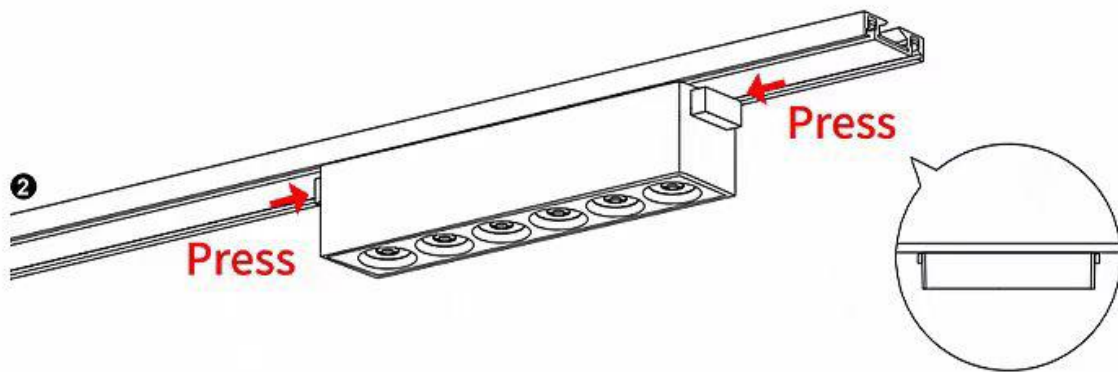
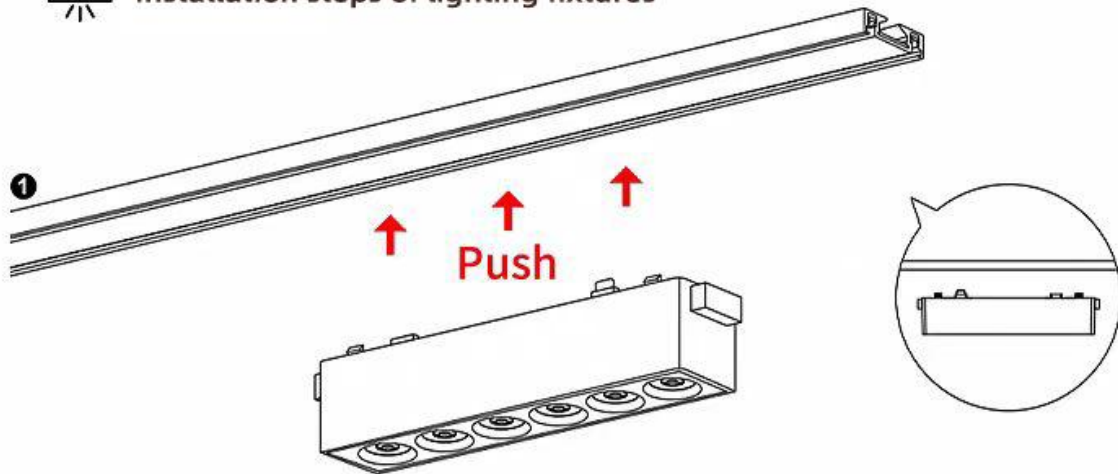

① Push the lamp onto the track bar so that the copper plate of the lamp contacts the silver bar on the track bar and is energized

② After confirming that the light fixture is powered on, press the buttons on both sides to fix the light fixture on the track and install it successfully.

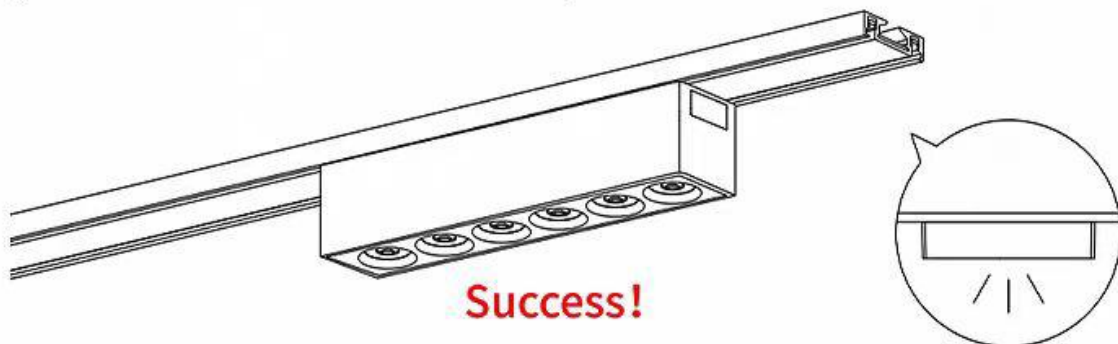

Dongguan Fitlight Lighting Co.,Ltd.

Add: 10th floor, building C1, Songhu Zhigu building, No. 9, Yanhe South Road, Liaobu Town, Dongguan City, Guangdong Province, China.

Email : [liu@fitlight-tech.com](mailto:liu@fitlight-tech.com) URL: [www.fitlight-tech.com](http://www.fitlight-tech.com) / <https://fitlight.en.alibaba.com>

### Real Feedback From Customers



Dongguan Fitlight Lighting Co.,Ltd.

Add: 10th floor, building C1, Songhu Zhigu building, No. 9, Yanhe South Road, Liaobu Town, Dongguan City, Guangdong Province, China.

Email : [liu@fitlight-tech.com](mailto:liu@fitlight-tech.com) URL: [www.fitlight-tech.com](http://www.fitlight-tech.com) / <https://fitlight.en.alibaba.com>