

**Thanks for choosing our products, in order to protect your consumption right and personal safety, please read this instruction carefully before uses and keep this as the future reference.**

## **Attention:**

- Before installing the luminaire, please check whether the rated voltage of the luminaire is consistent with the voltage of the wiring power supply to avoid damage to the luminaire due to voltage inconsistency.
- Touching these parts without disconnecting the power supply may cause an electric shock. So, installation must be done by professional electrician.
- Please ensure the power has been cut off before installation, in order to prevent the electric shock, make sure the power supply that can't be resumed by anybody before the job done.
- Keep the surface of the lamp housing and transparent parts clean to ensure good light transmission.
- Plastic materials are used in some parts of the spotlight. Applying organic solvents (such as benzene), or other chemicals for cleaning may cause deformation or discolouration. Clean the device gently, using a soft dry cloth.
- Each fixing screw must be tightened when installing.
- The cable entry line should be fixed and prevented from pulling the wire and damaging the lamp.
- Avoid collision with hard objects to avoid scratches.
- Do not spray or pour water on the unit, this may cause an electric shock.
- Do not install the unit in locations subject to high and/or low temperatures (this may damage the LED lamp).
- The maintenance should be done by the professional. The luminaire must be grounded reliably and non-professionals must not disassemble the luminaire.
- The front-end power supply must be cut off during installation. The power supply must be cut off when repairing or replacing parts.
- The defective ballast could not be treated as the normal rubbish and should be returned and make use of the normal parts.
- Regarding the repair of the equipment contact Technical Support.

Dongguan Fitlight Lighting Co.,Ltd.

Add: 10th floor, building C1, Songhu Zhigu building, No. 9, Yanhe South Road, Liaobu Town, Dongguan City, Guangdong Province, China.

Email : [liu@fitlight-tech.com](mailto:liu@fitlight-tech.com) URL: [www.fitlight-tech.com](http://www.fitlight-tech.com) / <https://fitlight.en.alibaba.com>



## OEM/ODM

### Professional Lighting Product Manufacturer

1. 14+ Years of Industry Leadership
2. Full Customization (OEM/ODM)
3. Certified Excellence: Globally recognized certifications (CE, RoHS, SAA, etc.)
4. Energy-Efficient & Sustainable Solutions
5. Competitive Pricing & Fast Turnaround
6. Dedicated R&D & Continuous Innovation



**14**<sup>+years</sup>  
Production experience

**3000**<sup>+m<sup>2</sup></sup>  
Factory space

**50**<sup>+</sup>  
Patent certificate

**100**<sup>+</sup>  
Projects

**10000**<sup>+pcs</sup>  
Daily output value

**100**<sup>+</sup>  
Service country



Dongguan Fitlight Lighting Co.,Ltd.

Add: 10th floor, building C1, Songhu Zhigu building, No. 9, Yanhe South Road, Liaobu Town, Dongguan City, Guangdong Province, China.

Email : [liu@fitlight-tech.com](mailto:liu@fitlight-tech.com) URL: [www.fitlight-tech.com](http://www.fitlight-tech.com) / <https://fitlight.en.alibaba.com>

# FEITL Anti Glare Three Heads Down Light-GL08 Series

## Features and Benefits

- Light source: COB LED
- Long LED life: More than 50,000 hours
- Low heat, less than 60°C
- No UV or IR light radiation
- No mercury or other inorganic
- Homogeneous flood illumination
- Machined aluminum heat fins with excellent thermal efficiencies
- The LED down light is available in the following white color temperatures:  
2700/3000/4000/5000/6000K
- 3 or 5 years limited warranty(3 years for Epistar LED chip model and 5 years for OSRAM LED chip version)
- Works with worldwide lighting systems  
110VAC/220VAC



## Typical Applications

- Spot lighting
- Retail Store lighting
- Commercial lighting
- Residential lighting
- General lighting
- Energy Saving Programs
- Sustainable Energy



White



DC connector with Lock



Black



Brand Driver

Dongguan Fitlight Lighting Co.,Ltd.

Add: 10th floor, building C1, Songhu Zhigu building, No. 9, Yanhe South Road, Liaobu Town, Dongguan City, Guangdong Province, China.

Email : [liu@fitlight-tech.com](mailto:liu@fitlight-tech.com) URL: [www.fitlight-tech.com](http://www.fitlight-tech.com) / <https://fitlight.en.alibaba.com>

## PRODUCT SPECIFICATIONS

<b>LAMP TYPE</b>	Surface Mounted Down light series
<b>LIGHT SOURCE</b>	Cree/OSRAM or Epistar COB LED (Other driver brands can also choose from)
<b>Driver</b>	Osram / Tridonic/ LIFUD (Other driver brands can also choose from)
<b>Input voltage (volts)</b>	AC 110V ( ± 10%)/AC 220V( ± 10%)
<b>Power</b>	3*7/ 3*10/ 3*12/ 3*15W
<b>BEAM ANGLE</b>	15°/24°/38°±3°
<b>RENDERING INDEX (Ra)</b>	>80Ra or 90Ra
<b>Material Quality</b>	Aluminum
<b>Color Temperature</b>	Warm White(2700K/3000K) / Natural White(4000K) / Cool white(5000K/6000K)
<b>Efficiency</b>	85-90lm/w±10% for non-dimmable model; 80-85lm/w±10% for dimmable model; 100/110/120lm/w Can Be Customized
<b>OPTICS</b>	Aluminum coating reflector
<b>HEATSINK</b>	Machined pure aluminum with anodize finish
<b>Installation</b>	Surface mounted
<b>BASE TYPE</b>	External Driver
<b>DIMMABILITY</b>	Dimmable(0-10V /Triac /Dali) / or Non-dimmable Model
<b>Key Feature 1</b>	Aluminum Cob Anti-glare Down Lights
<b>Key Feature 2</b>	Anti glare and flicker free surface mounted down light
<b>Certification</b>	CE/EMC/LVD/ROHS(Whole lamp);Driver(CE/EMC/LVD/ROHS/CB/SAA/UL)

## ENVIRONMENTAL SPECIFICATIONS

<b>TEMPERATURE RANGE</b>	Ambient: -20°C to 40°C; Surface of Lamp: 60°C to 70°C
<b>HUMIDITY RANGE</b>	0 to 95% non-condensing humidity

## PRODUCT CODE: FT-GL08-3\* X<sub>1</sub>/X<sub>2</sub>

X1: Power

X2: LED chip(OSRAM / Cree or Epistar / bridgelux )

Dongguan Fitlight Lighting Co.,Ltd.

Add: 10th floor, building C1, Songhu Zhigu building, No. 9, Yanhe South Road, Liaobu Town, Dongguan City, Guangdong Province, China.

Email : [liu@fitlight-tech.com](mailto:liu@fitlight-tech.com) URL: [www.fitlight-tech.com](http://www.fitlight-tech.com) / <https://fitlight.en.alibaba.com>

# FEITL Anti Glare Three Heads Down Light-GL08 Series



Surface Mounted  
Downlight

3\*7W/3\*10W/3\*12W/3\*15W Flicker Free

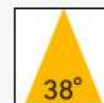
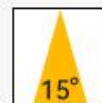

Dongguan Fitlight Lighting Co.,Ltd.

Add: 10th floor, building C1, Songhu Zhigu building, No. 9, Yanhe South Road, Liaobu Town, Dongguan City, Guangdong Province, China.

Email : [liu@fitlight-tech.com](mailto:liu@fitlight-tech.com) URL: [www.fitlight-tech.com](http://www.fitlight-tech.com) / <https://fitlight.en.alibaba.com>

# FEITL Anti Glare Three Heads Down Light-GL08 Series

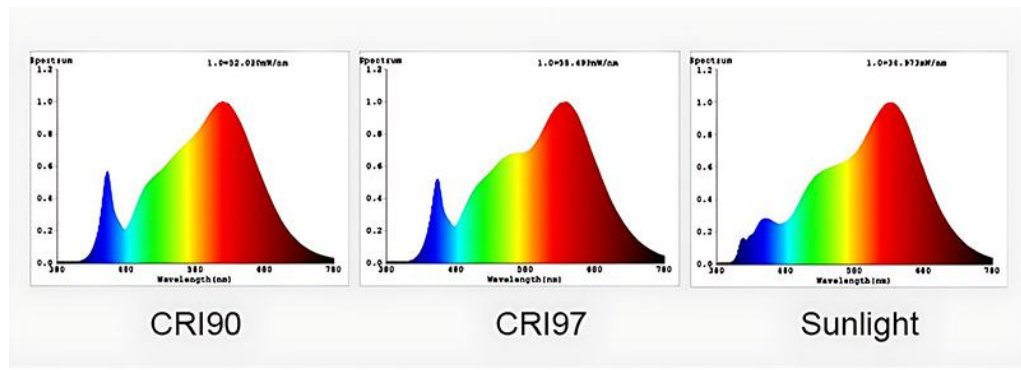

## CCT option



## Material Brand Cooperation

PHILIPS

CREE

OSRAM

EAGLERISE

LIFUD

bridgelux

powered by  
TRIDONIC

LUMINUS

EPISTAR

BOKE

KR  
KERUI GROUP

CITILED®  
The Light Engine

### COB brand



Other brands are also available

### Power brand



Five-year warranty, no flicker PF > 0.9

Dongguan Fitlight Lighting Co.,Ltd.

Add: 10th floor, building C1, Songhu Zhigu building, No. 9, Yanhe South Road, Liaobu Town, Dongguan City, Guangdong Province, China.

Email : [liu@fitlight-tech.com](mailto:liu@fitlight-tech.com)    URL: [www.fitlight-tech.com](http://www.fitlight-tech.com) / <https://fitlight.en.alibaba.com>

# FEITL Anti Glare Three Heads Down Light-GL08 Series

The inner cup has multiple colors to choose from

Matt White / Matt Black /Gun Black/Mute silver/Bright Silver/ Rose Gold /Champagne Gold

**Product parameters**

Model	Power	Cut out	Dimension	Beam Angle
One head	7W	Surface Mounted	L105*W105*H130	15° 24° 38°
	10-12W	Surface Mounted	L105*W105*H130	15° 24° 38°
	15W	Surface Mounted	L105*W105*H130	15° 24° 38°
Two head	7*2W	Surface Mounted	L200*W105*H130	15° 24° 38°
	10-12W*2	Surface Mounted	L200*W105*H130	15° 24° 38°
	15*2W	Surface Mounted	L200*W105*H130	15° 24° 38°
Three head	7*3W	Surface Mounted	L295*W105*H130	15° 24° 38°
	10-12W*3	Surface Mounted	L295*W105*H130	15° 24° 38°
	15*3W	Surface Mounted	L295*W105*H130	15° 24° 38°
Four head	7*4W	Surface Mounted	L200*W200*H130	15° 24° 38°
	10-12W*4	Surface Mounted	L200*W200*H130	15° 24° 38°
	15*4W	Surface Mounted	L200*W200*H130	15° 24° 38°

Dongguan Fitlight Lighting Co.,Ltd.

Add: 10th floor, building C1, Songhu Zhigu building, No. 9, Yanhe South Road, Liaobu Town, Dongguan City, Guangdong Province, China.

Email : [liu@fitlight-tech.com](mailto:liu@fitlight-tech.com) URL: [www.fitlight-tech.com](http://www.fitlight-tech.com) / <https://fitlight.en.alibaba.com>

# FEITL Anti Glare Three Heads Down Light-GL08 Series



**Single-head**



**Double headed**



**Three headed**

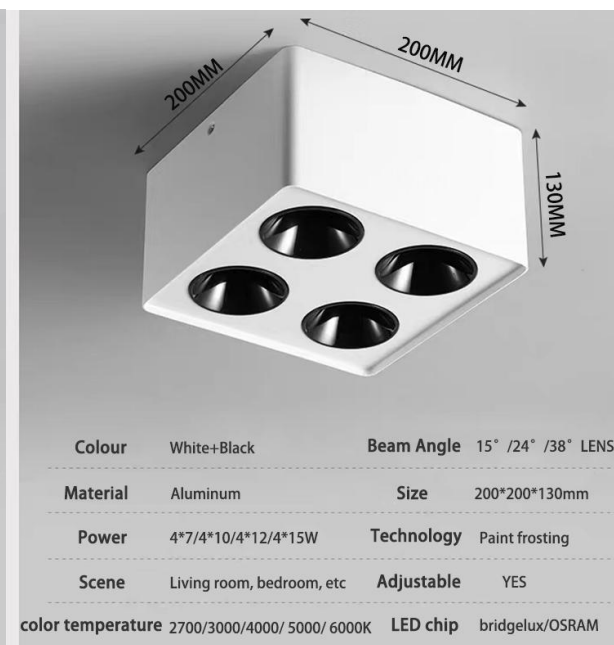

**Four headed**

Dongguan Fitlight Lighting Co.,Ltd.

Add: 10th floor, building C1, Songhu Zhigu building, No. 9, Yanhe South Road, Liaobu Town, Dongguan City, Guangdong Province, China.

Email : [liu@fitlight-tech.com](mailto:liu@fitlight-tech.com) URL: [www.fitlight-tech.com](http://www.fitlight-tech.com) / <https://fitlight.en.alibaba.com>

# FEITL Anti Glare Three Heads Down Light-GL08 Series



Dongguan Fitlight Lighting Co.,Ltd.

Add: 10th floor, building C1, Songhu Zhigu building, No. 9, Yanhe South Road, Liaobu Town, Dongguan City, Guangdong Province, China.

Email : [liu@fitlight-tech.com](mailto:liu@fitlight-tech.com) URL: [www.fitlight-tech.com](http://www.fitlight-tech.com) / <https://fitlight.en.alibaba.com>

## Anti glare flicker free

Hidden light source: increase the shading angle, filter out stray light, and make the light soft and glare free

Anti glare inner ring: Aluminum inner ring, frosted inner wall reduces light emission, and the light spot is more uniform and full

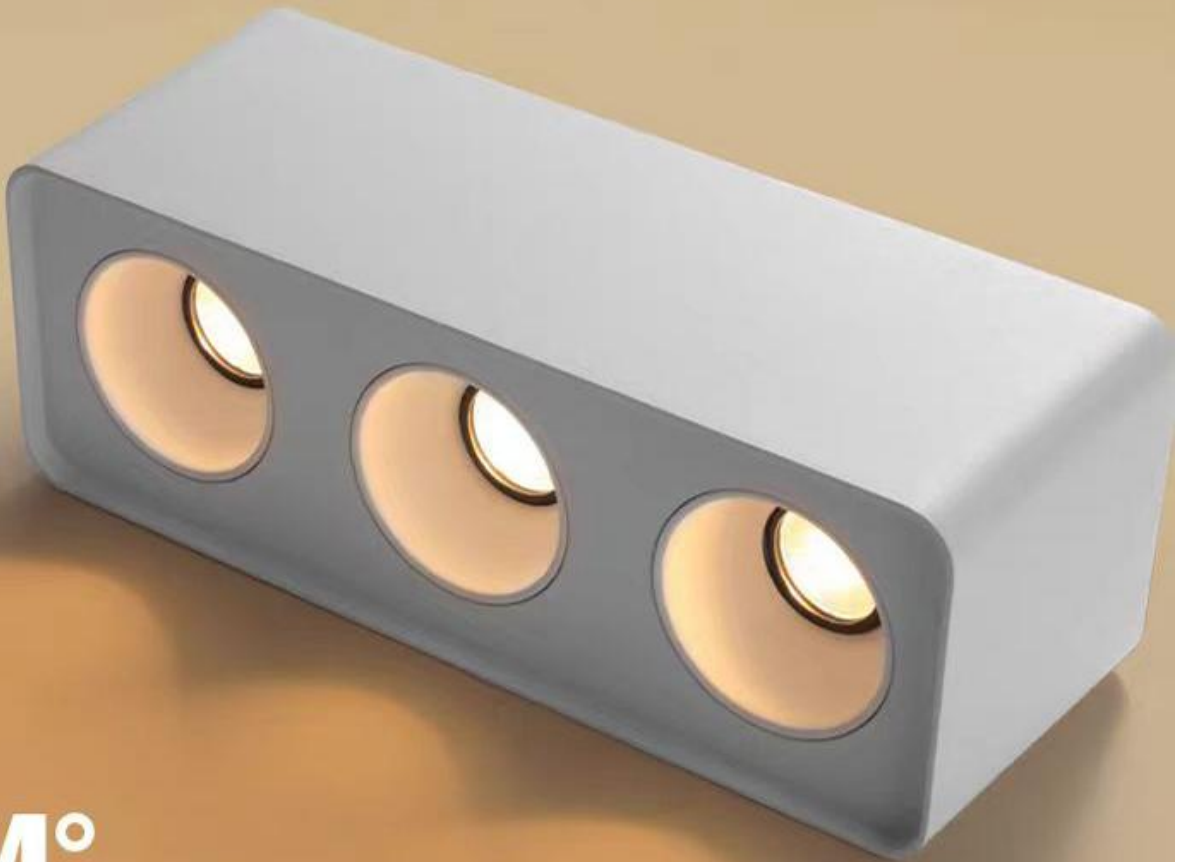

24°

Dongguan Fitlight Lighting Co.,Ltd.

Add: 10th floor, building C1, Songhu Zhigu building, No. 9, Yanhe South Road, Liaobu Town, Dongguan City, Guangdong Province, China.

Email : [liu@fitlight-tech.com](mailto:liu@fitlight-tech.com) URL: [www.fitlight-tech.com](http://www.fitlight-tech.com) / <https://fitlight.en.alibaba.com>

# FEITL Anti Glare Three Heads Down Light-GL08 Series

## Product Details



Different light cup colors can be selected



### Brand chip optional :

CREE / EPISTAR / CITELED / LUMINUS / OSRAM  
(Mainly COB series) CRI > 90, HighCRI (CRI 98)  
and high luminous efficiency can be customized  
CCT: 2700K/3000K/4000K/ 5000K/6500K

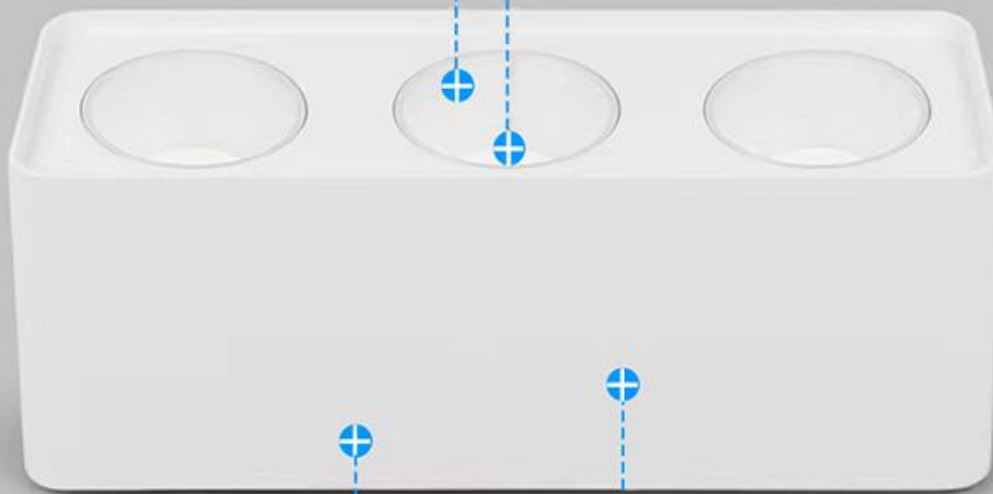

### High Efficiency Radiator

Thickened precision aluminium radiator,  
one-piece aluminium, high efficiency, fast  
heat dissipation.

### Shell color

White and Black

Dongguan Fitlight Lighting Co.,Ltd.

Add: 10th floor, building C1, Songhu Zhigu building, No. 9, Yanhe South Road, Liaobu Town, Dongguan City, Guangdong Province, China.

Email : [liu@fitlight-tech.com](mailto:liu@fitlight-tech.com) URL: [www.fitlight-tech.com](http://www.fitlight-tech.com) / <https://fitlight.en.alibaba.com>

# FEITL Anti Glare Three Heads Down Light-GL08 Series



Dongguan Fitlight Lighting Co.,Ltd.

Add: 10th floor, building C1, Songhu Zhigu building, No. 9, Yanhe South Road, Liaobu Town, Dongguan City, Guangdong Province, China.

Email : [liu@fitlight-tech.com](mailto:liu@fitlight-tech.com) URL: [www.fitlight-tech.com](http://www.fitlight-tech.com) / <https://fitlight.en.alibaba.com>

# FEITL Anti Glare Three Heads Down Light-GL08 Series



Dongguan Fitlight Lighting Co.,Ltd.

Add: 10th floor, building C1, Songhu Zhigu building, No. 9, Yanhe South Road, Liaobu Town, Dongguan City, Guangdong Province, China.

Email : [liu@fitlight-tech.com](mailto:liu@fitlight-tech.com) URL: [www.fitlight-tech.com](http://www.fitlight-tech.com) / <https://fitlight.en.alibaba.com>

# FEITL Anti Glare Three Heads Down Light-GL08 Series



Dongguan Fitlight Lighting Co.,Ltd.

Add: 10th floor, building C1, Songhu Zhigu building, No. 9, Yanhe South Road, Liaobu Town, Dongguan City, Guangdong Province, China.

Email : [liu@fitlight-tech.com](mailto:liu@fitlight-tech.com) URL: [www.fitlight-tech.com](http://www.fitlight-tech.com) / <https://fitlight.en.alibaba.com>

# FEITL Anti Glare Three Heads Down Light-GL08 Series



Dongguan Fitlight Lighting Co.,Ltd.

Add: 10th floor, building C1, Songhu Zhigu building, No. 9, Yanhe South Road, Liaobu Town, Dongguan City, Guangdong Province, China.

Email : [liu@fitlight-tech.com](mailto:liu@fitlight-tech.com) URL: [www.fitlight-tech.com](http://www.fitlight-tech.com) / <https://fitlight.en.alibaba.com>

## DIMMABLE

Single color dimmable



TRIAC



0-10V



DALI

2700-6000K tunable



2.4G

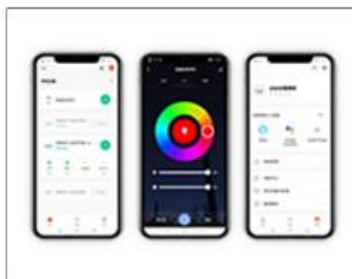

TUYA  
(Bluetooth WiFi ZIGBEE)



DALI DT8

### LED Down light Model at Ta=25°

Parameter	Symbol	Min	Type	Max	Unit
Input Voltage (AC)	V <sub>AC</sub>	165	230	265	V
Estimated Life <sup>[*]</sup>		—	50,000	—	hours
Optimized Body Temperature	T	—	55	60	°C

Note[\*] – Manufacturer projects Down Light made with COB LED to maintain an average of 70% lumens maintenance after 30,000 hours. This estimation is made based on data from LED manufacturer

Dongguan Fitlight Lighting Co.,Ltd.

Add: 10th floor, building C1, Songhu Zhigu building, No. 9, Yanhe South Road, Liaobu Town, Dongguan City, Guangdong Province, China.

Email : [liu@fitlight-tech.com](mailto:liu@fitlight-tech.com) URL: [www.fitlight-tech.com](http://www.fitlight-tech.com) / <https://fitlight.en.alibaba.com>

# FEITL Anti Glare Three Heads Down Light-GL08 Series

## Installation of lamps for surface mounted downlight:

Surface-mounted installation, the lamp head shall be rotated for 3 turns to the left first, and then tightened clockwise and fixed to the right. If it is tightened directly clockwise, the power line will be pulled off, resulting in poor contact of the lamp or the lamp is not bright.

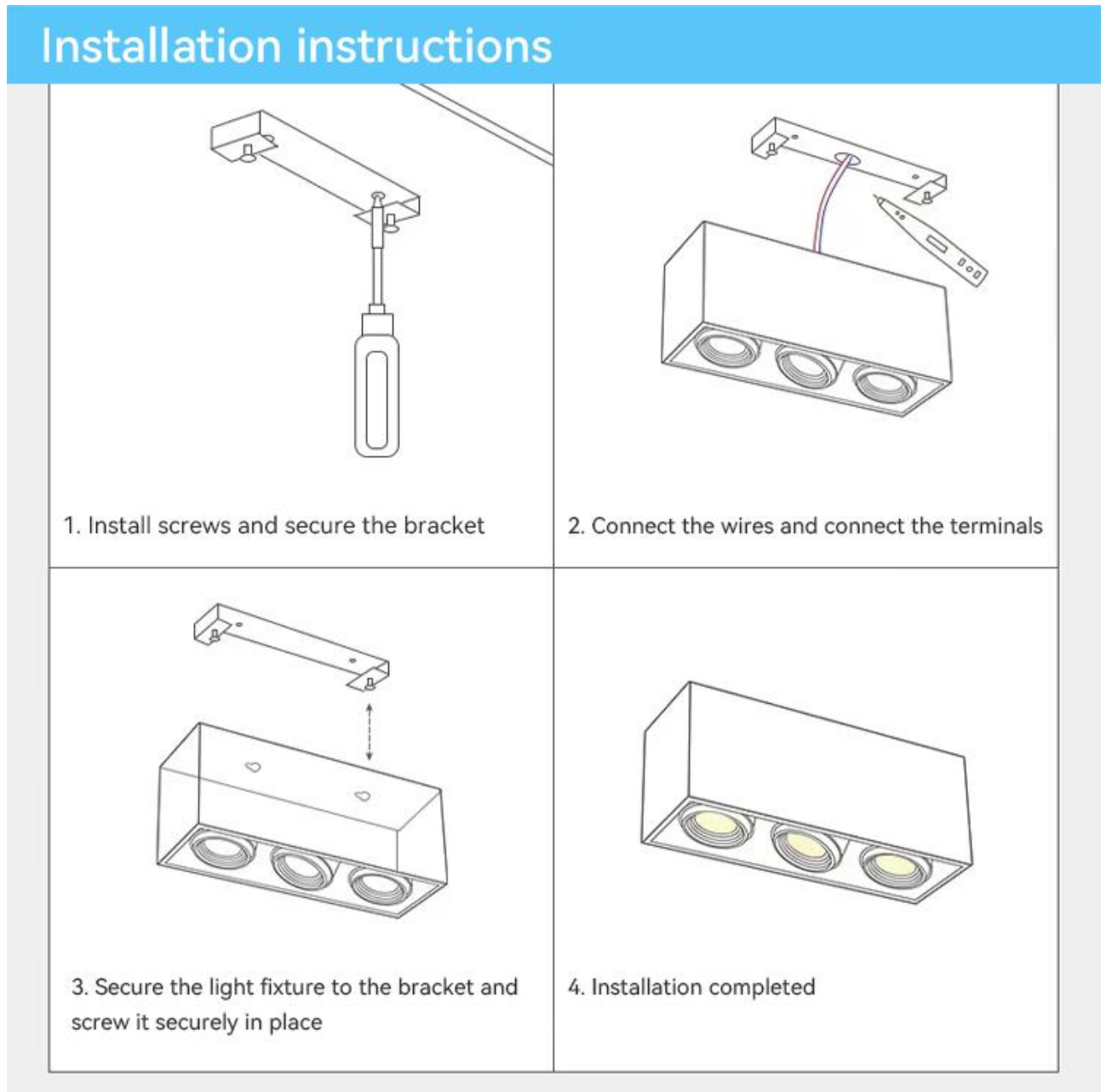

The front-end power supply must be cut off during installation. The power supply must be cut off when repairing or replacing parts.

Dongguan Fitlight Lighting Co.,Ltd.

Add: 10th floor, building C1, Songhu Zhigu building, No. 9, Yanhe South Road, Liaobu Town, Dongguan City, Guangdong Province, China.

Email : [liu@fitlight-tech.com](mailto:liu@fitlight-tech.com) URL: [www.fitlight-tech.com](http://www.fitlight-tech.com) / <https://fitlight.en.alibaba.com>

# FEITL Anti Glare Three Heads Down Light-GL08 Series

## INSTALL APPLICATION



Dongguan Fitlight Lighting Co.,Ltd.

Add: 10th floor, building C1, Songhu Zhigu building, No. 9, Yanhe South Road, Liaobu Town, Dongguan City, Guangdong Province, China.

Email : [liu@fitlight-tech.com](mailto:liu@fitlight-tech.com) URL: [www.fitlight-tech.com](http://www.fitlight-tech.com) / <https://fitlight.en.alibaba.com>

## Caution:

- WARNING-Risk of fire or electric shock. LED Down light installation requires knowledge of luminaire electrical systems.
- If not qualified, do not attempt installation. Contact a qualified electrician.
- WARNING-To prevent wiring damage or abrasion, do not expose wiring to edges of sheet ; metal or other sharp objects.

## Hygiene & Safety

- Provide the illumination required in the work area for moving parts.
- We advise to use the soft cloth to clean up and do not attempt to use any chemical agent.
- In order to avoid any damages from the surface.
- Minimize the accumulation of dirt on the lamps and spotlights;
- For your safety, please cut off the power supply before changing or cleaning the lamp source.
- Facilitate maintenance.

Dongguan Fitlight Lighting Co.,Ltd.

Add: 10th floor, building C1, Songhu Zhigu building, No. 9, Yanhe South Road, Liaobu Town, Dongguan City, Guangdong Province, China.

Email : [liu@fitlight-tech.com](mailto:liu@fitlight-tech.com) URL: [www.fitlight-tech.com](http://www.fitlight-tech.com) / <https://fitlight.en.alibaba.com>