

**Thanks for choosing our products, in order to protect your consumption right and personal safety, please read this instruction carefully before uses and keep this as the future reference.**

**Attention:**

- Before installing the luminaire, please check whether the rated voltage of the luminaire is consistent with the voltage of the wiring power supply to avoid damage to the luminaire due to voltage inconsistency.
- Touching these parts without disconnecting the power supply may cause an electric shock. So, installation must be done by professional electrician.
- Please ensure the power has been cut off before installation, in order to prevent the electric shock, make sure the power supply that can't be resumed by anybody before the job done.
- Keep the surface of the lamp housing and transparent parts clean to ensure good light transmission.
- Plastic materials are used in some parts of the spotlight. Applying organic solvents (such as benzene), or other chemicals for cleaning may cause deformation or discolouration. Clean the device gently, using a soft dry cloth.
- Each fixing screw must be tightened when installing.
- The cable entry line should be fixed and prevented from pulling the wire and damaging the lamp.
- Avoid collision with hard objects to avoid scratches.
- Do not spray or pour water on the unit, this may cause an electric shock.
- Do not install the unit in locations subject to high and/or low temperatures (this may damage the LED lamp).
- The maintenance should be done by the professional. The luminaire must be grounded reliably and non-professionals must not disassemble the luminaire.
- The front-end power supply must be cut off during installation. The power supply must be cut off when repairing or replacing parts.
- The defective ballast could not be treated as the normal rubbish and should be returned and make use of the normal parts.
- Regarding the repair of the equipment contact Technical Support.

Dongguan Fitlight Lighting Co.,Ltd.

Add: 10th floor, building C1, Songhu Zhigu building, No. 9, Yanhe South Road, Liaobu Town, Dongguan City, Guangdong Province, China.

Email : [liu@fitlight-tech.com](mailto:liu@fitlight-tech.com) URL: [www.fitlight-tech.com](http://www.fitlight-tech.com) / <https://fitlight.en.alibaba.com>

**FEITL**  
 东莞市菲特莱照明有限公司  
 DONGGUAN FITLIGHT LIGHTING CO.,LTD

## OEM/ODM

### Professional Lighting Product Manufacturer

- 1.14+ Years of Industry Leadership
- 2.Full Customization (OEM/ODM)
- 3.Certified Excellence: Globally recognized certifications (CE, RoHS, SAA, etc.)
- 4.Energy-Efficient & Sustainable Solutions
- 5.Competitive Pricing & Fast Turnaround
- 6.Dedicated R&D & Continuous Innovation

**14**<sup>+years</sup>  
 Production experience

**3000**<sup>+m<sup>2</sup></sup>  
 Factory space

**50**<sup>+</sup>  
 Patent certificate

**100**<sup>+</sup>  
 Projects

**10000**<sup>+pcs</sup>  
 Daily output value

**100**<sup>+</sup>  
 Service country



Dongguan Fitlight Lighting Co.,Ltd.

Add: 10th floor, building C1, Songhu Zhigu building, No. 9, Yanhe South Road, Liaobu Town, Dongguan City, Guangdong Province, China.

Email : [liu@fitlight-tech.com](mailto:liu@fitlight-tech.com) URL: [www.fitlight-tech.com](http://www.fitlight-tech.com) / <https://fitlight.en.alibaba.com>

### Features and Benefits

- Light source: COB LED
- Long LED life: More than 50,000 hours
- Low heat, less than 60°C
- No UV or IR light radiation
- No mercury or other inorganic
- Homogeneous flood illumination
- Machined aluminum heat fins with excellent thermal efficiencies
- The LED down light is available in the following white color temperatures: 2700/3000/3500/4000/5000/6000K
- 3 or 5 years limited warranty(3 years for Epistar LED chip model and 5 years for OSRAM/CREE LED chip version)
- Works with worldwide lighting systems 110VAC/220VAC



### Typical Applications

- Spot lighting
- Retail Store lighting
- Commercial lighting
- Residential lighting
- General lighting
- Energy Saving Programs
- Sustainable Energy
- School, university, hospital, hotel
- Conference, meeting room, show room, showcase
- Commercial complexes
- Factory, plant, warehouse, office
- Supermarket, department store



Dongguan Fitlight Lighting Co.,Ltd.

Add: 10th floor, building C1, Songhu Zhigu building, No. 9, Yanhe South Road, Liaobu Town, Dongguan City, Guangdong Province, China.

Email : [liu@fitlight-tech.com](mailto:liu@fitlight-tech.com) URL: [www.fitlight-tech.com](http://www.fitlight-tech.com) / <https://fitlight.en.alibaba.com>

## PRODUCT SPECIFICATIONS

<b>LAMP TYPE</b>	Integrated High Luminous Efficiency 160LM/W LED Track Light Series
<b>LIGHT SOURCE</b>	Cree/OSRAM or Bridgelux COB LED (Other driver brands can also choose from)
<b>Driver</b>	Osram / Tridonic/ LIFUD (Other driver brands can also choose from)
<b>Input voltage (volts)</b>	AC 110V ( ± 10%)/AC 220V( ± 10%)
<b>Power</b>	25W/30W/35W/40W/45W
<b>BEAM ANGLE</b>	38°/60° ±3°
<b>RENDERING INDEX (Ra)</b>	> 90Ra
<b>Material Quality</b>	Aluminum
<b>Color Temperature</b>	Warm White(2700K/3000K/3500K) / Natural White(4000K) / Cool white(5000K/6000K)
<b>Efficiency</b>	160lm/w± 10% High Luminous Efficiency
<b>OPTICS</b>	Reflector
<b>HEATSINK</b>	Machined pure aluminum with anodize finish
<b>BASE TYPE</b>	2/3/4-phase
<b>Installation</b>	Track Mounted
<b>DIMMABILITY</b>	Dimmable(0-10V /Triac /Dali) / or Non-dimmable Model
<b>Key Feature 1</b>	Adjustable Angle Aluminum Cob Shop Supermarket Track Lights
<b>Key Feature 2</b>	Hotel / Residential Living Room Led Track Spotlight
<b>Certification</b>	CE/EMC/LVD/ROHS/SAA(Whole lamp);Driver(CE/EMC/LVD/ROHS/CB/SAA/UL)

## ENVIRONMENTAL SPECIFICATIONS

<b>TEMPERATURE RANGE</b>	Ambient: -20°C to 40°C; Surface of Lamp: 60°C to 70°C
<b>HUMIDITY RANGE</b>	0 to 95% non-condensing humidity

## PRODUCT CODE: FT-TL06-X<sub>1</sub>/X<sub>2</sub>

X1: Power

X2: LED chip(OSRAM / Cree or Epistar / bridgelux )

Dongguan Fitlight Lighting Co.,Ltd.

Add: 10th floor, building C1, Songhu Zhigu building, No. 9, Yanhe South Road, Liaobu Town, Dongguan City, Guangdong Province, China.

Email : [liu@fitlight-tech.com](mailto:liu@fitlight-tech.com) URL: [www.fitlight-tech.com](http://www.fitlight-tech.com) / <https://fitlight.en.alibaba.com>



## LED TRACK LIGHT High Efficient 160LM/W

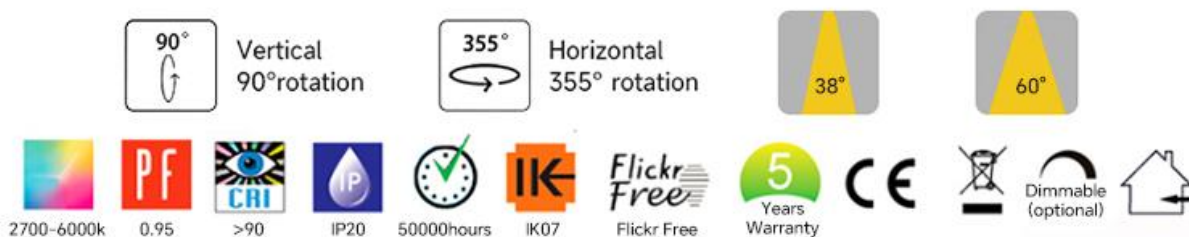

Dongguan Fitlight Lighting Co.,Ltd.

Add: 10th floor, building C1, Songhu Zhigu building, No. 9, Yanhe South Road, Liaobu Town, Dongguan City, Guangdong Province, China.

Email : [liu@fitlight-tech.com](mailto:liu@fitlight-tech.com) URL: [www.fitlight-tech.com](http://www.fitlight-tech.com) / <https://fitlight.en.alibaba.com>

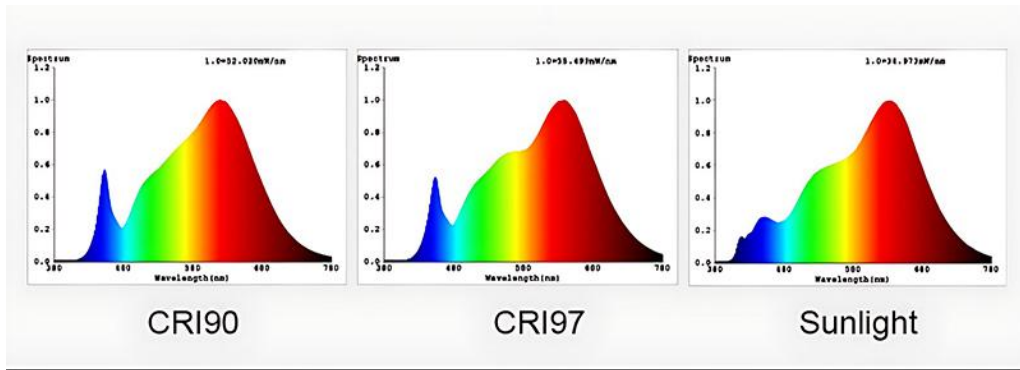

### CCT option



### Material Brand Cooperation



COB brand			Power brand			
OSRAM	CREE	Bridgelux	Lifud	Tridonic	NOVBO	Boke
Other brands are also available			Five-year warranty, no flicker PF>0.9			

Dongguan Fitlight Lighting Co.,Ltd.

Add: 10th floor, building C1, Songhu Zhigu building, No. 9, Yanhe South Road, Liaobu Town, Dongguan City, Guangdong Province, China.

Email : [liu@fitlight-tech.com](mailto:liu@fitlight-tech.com) URL: [www.fitlight-tech.com](http://www.fitlight-tech.com) / <https://fitlight.en.alibaba.com>

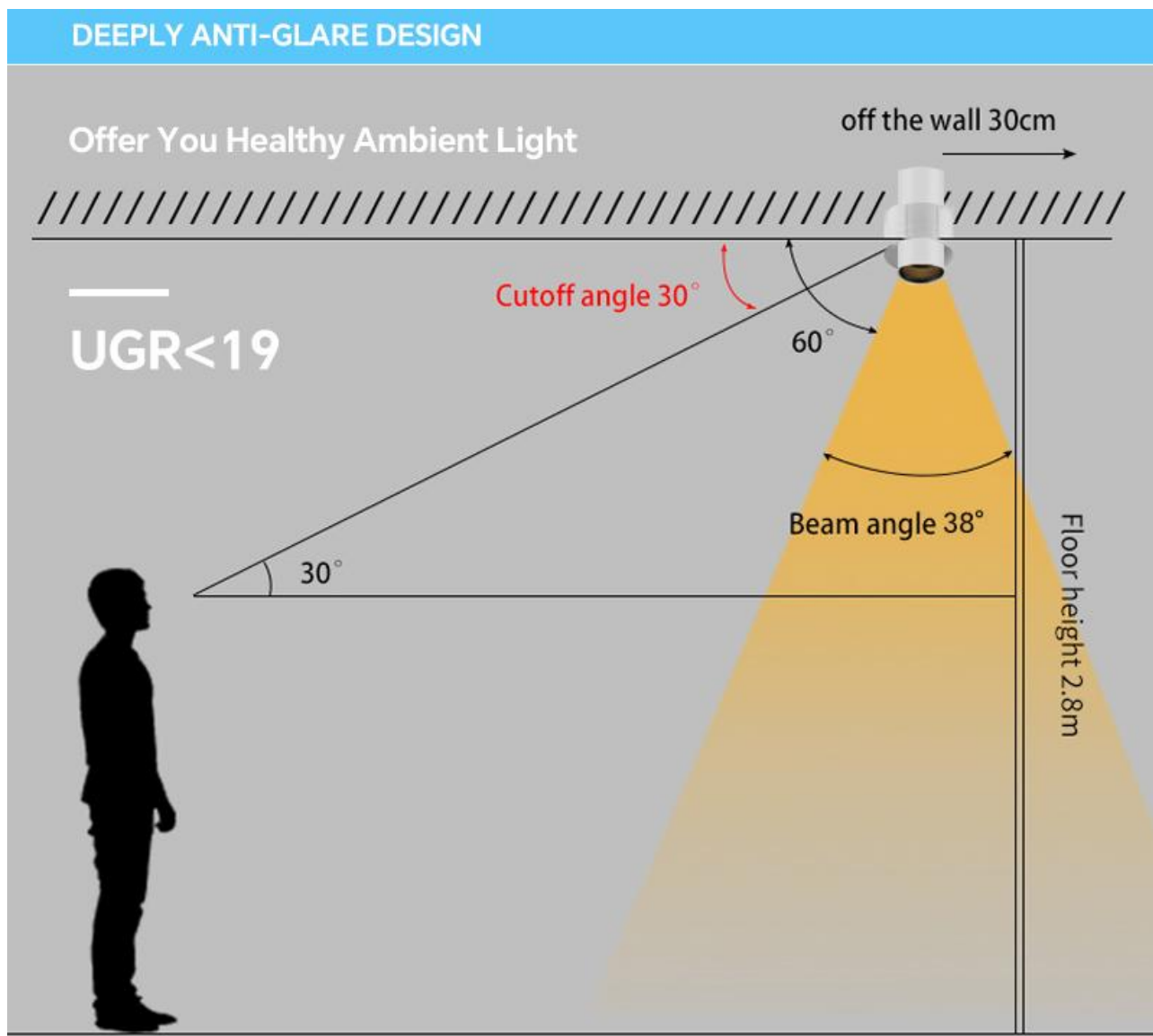

Dongguan Fitlight Lighting Co.,Ltd.

Add: 10th floor, building C1, Songhu Zhigu building, No. 9, Yanhe South Road, Liaobu Town, Dongguan City, Guangdong Province, China.

Email : [liu@fitlight-tech.com](mailto:liu@fitlight-tech.com) URL: [www.fitlight-tech.com](http://www.fitlight-tech.com) / <https://fitlight.en.alibaba.com>

The higher the CRI, the better it can express the true color of the object

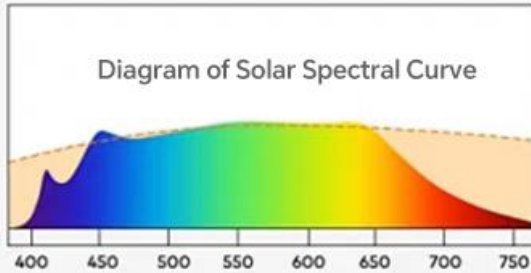

Our company's LED chips

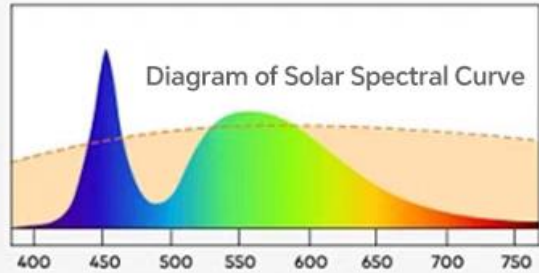

Ordinary LED chip



Ra≥90

Super high color reproduction ability  
Really restore natural colors



Ra≤80

Color rendering index is low  
Dull colors and blurry details

Dongguan Fitlight Lighting Co.,Ltd.

Add: 10th floor, building C1, Songhu Zhigu building, No. 9, Yanhe South Road, Liaobu Town, Dongguan City, Guangdong Province, China.

Email : [liu@fitlight-tech.com](mailto:liu@fitlight-tech.com) URL: [www.fitlight-tech.com](http://www.fitlight-tech.com) / <https://fitlight.en.alibaba.com>

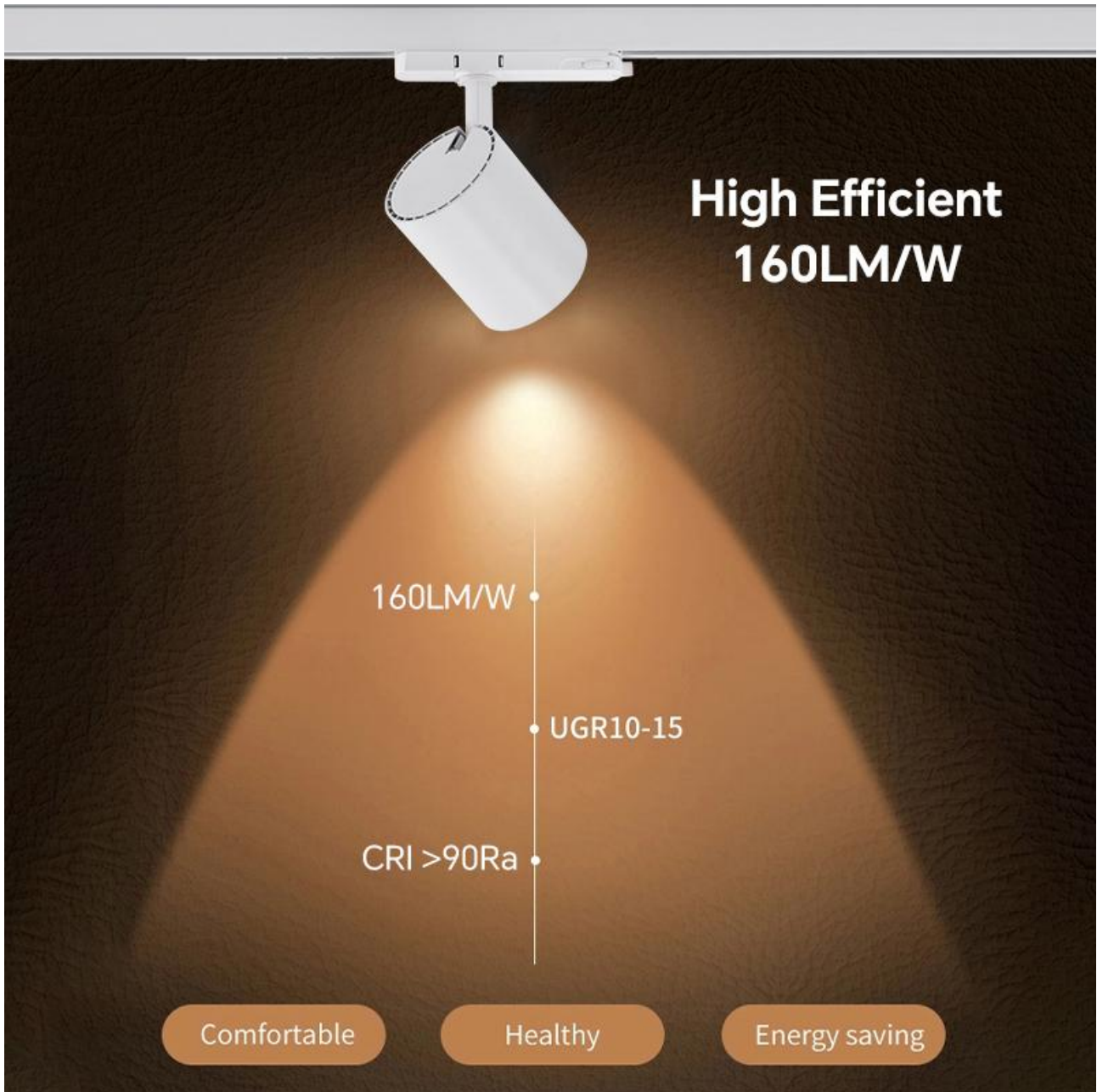

Dongguan Fitlight Lighting Co.,Ltd.

Add: 10th floor, building C1, Songhu Zhigu building, No. 9, Yanhe South Road, Liaobu Town, Dongguan City, Guangdong Province, China.

Email : [liu@fitlight-tech.com](mailto:liu@fitlight-tech.com) URL: [www.fitlight-tech.com](http://www.fitlight-tech.com) / <https://fitlight.en.alibaba.com>

## Free Rotation, Flexible Lighting

Combined with track movement, it provides precise lighting, allowing you to experience three - dimensional lighting effects in all directions. Suitable for both commercial and residential use.

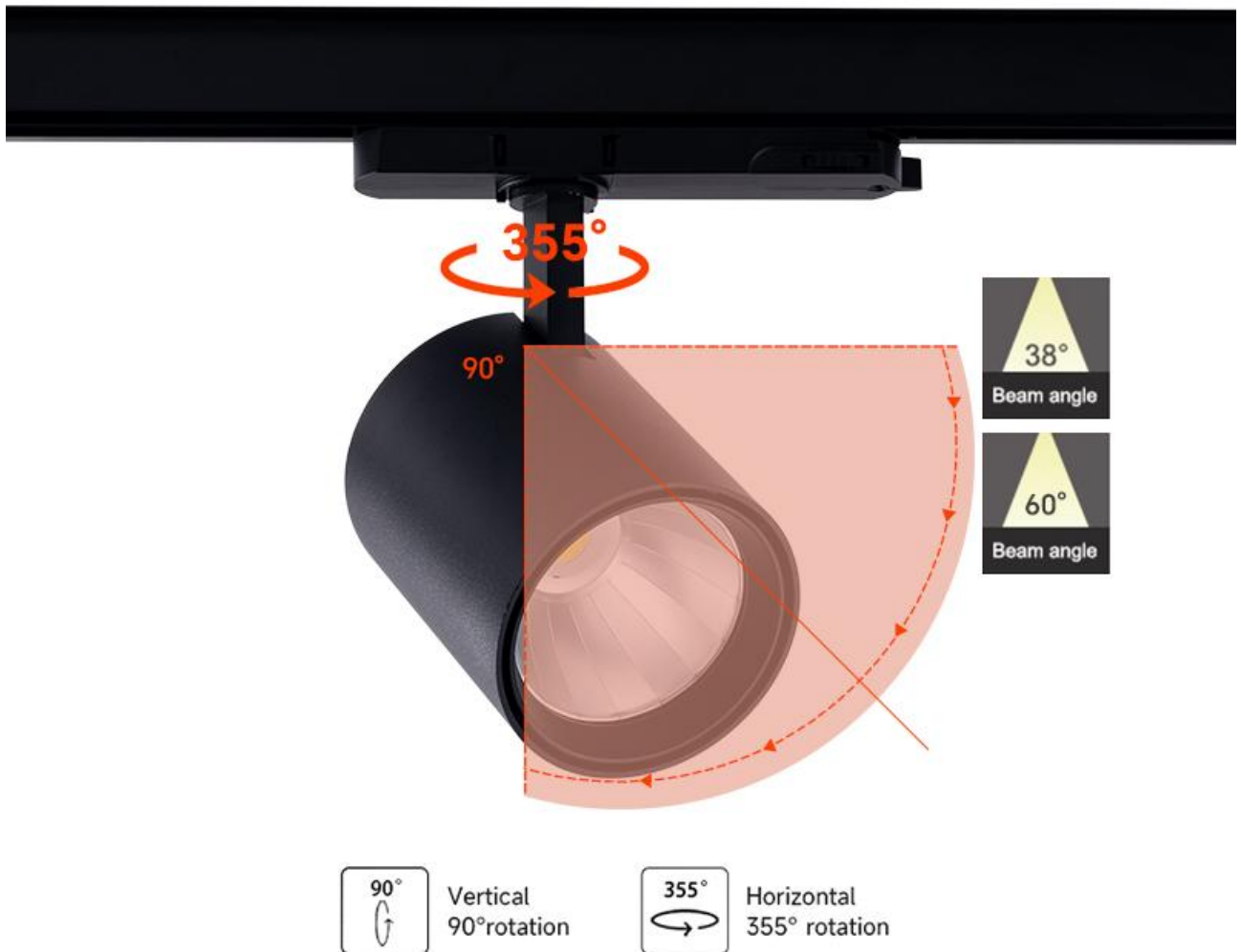

Dongguan Fitlight Lighting Co.,Ltd.

Add: 10th floor, building C1, Songhu Zhigu building, No. 9, Yanhe South Road, Liaobu Town, Dongguan City, Guangdong Province, China.

Email : [liu@fitlight-tech.com](mailto:liu@fitlight-tech.com) URL: [www.fitlight-tech.com](http://www.fitlight-tech.com) / <https://fitlight.en.alibaba.com>

## Three color temperature options Meet various lighting needs

White light has high lumen and color rendering,  
Iwarm light creates a cozy home atmosphere.



Dongguan Fitlight Lighting Co.,Ltd.

Add: 10th floor, building C1, Songhu Zhigu building, No. 9, Yanhe South Road, Liaobu Town, Dongguan City, Guangdong Province, China.

Email : [liu@fitlight-tech.com](mailto:liu@fitlight-tech.com) URL: [www.fitlight-tech.com](http://www.fitlight-tech.com) / <https://fitlight.en.alibaba.com>

## Product size



Power  
**25W 30W  
35W**

Power  
**40W  
45W**

113mm

91mm

130mm

105mm



2-way



3-way



4-way



4-way



6-way

### Single phase

### 3 phase



2-Wire 1-Circuit Track Rails

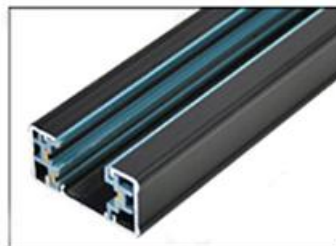

3-Wire 1-Circuit Track Rails

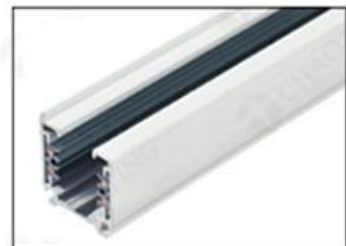

4-Wire 3-Circuit Track Rails

Dongguan Fitlight Lighting Co.,Ltd.

Add: 10th floor, building C1, Songhu Zhigu building, No. 9, Yanhe South Road, Liaobu Town, Dongguan City, Guangdong Province, China.

Email : [liu@fitlight-tech.com](mailto:liu@fitlight-tech.com) URL: [www.fitlight-tech.com](http://www.fitlight-tech.com) / <https://fitlight.en.alibaba.com>

## Product display



White Front



Black Front



Front



Back

Dongguan Fitlight Lighting Co.,Ltd.

Add: 10th floor, building C1, Songhu Zhigu building, No. 9, Yanhe South Road, Liaobu Town, Dongguan City, Guangdong Province, China.

Email : [liu@fitlight-tech.com](mailto:liu@fitlight-tech.com) URL: [www.fitlight-tech.com](http://www.fitlight-tech.com) / <https://fitlight.en.alibaba.com>

## DIMMABLE

### Adjustable Brightness



TRIAC



0-10V



DALI

### Both CCT And Brightness Adjustable



### TUYA Zigbee or TUYA Bluetooth



### LED Track Light Model at Ta=25°

Parameter	Symbol	Min	Type	Max	Unit
Input Voltage (AC)	V <sub>AC</sub>	165	230	265	V
Estimated Life[*]		—	50,000	—	hours
Optimized Body Temperature	T	—	55	60	°C

Note[\*] – Manufacturer projects Down Light made with COB LED to maintain an average of 70% lumens maintenance after 30,000 hours. This estimation is made based on data from LED manufacturer

Dongguan Fitlight Lighting Co.,Ltd.

Add: 10th floor, building C1, Songhu Zhigu building, No. 9, Yanhe South Road, Liaobu Town, Dongguan City, Guangdong Province, China.

Email : [liu@fitlight-tech.com](mailto:liu@fitlight-tech.com) URL: [www.fitlight-tech.com](http://www.fitlight-tech.com) / <https://fitlight.en.alibaba.com>

## Diagram Of Track Rail



### Length

1000mm  
1500mm  
2000mm  
3000mm

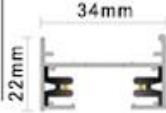

### Two Line Track system

1. Can be compatible with all major brands.
2. The contact area of flat copper is larger than round copper.
3. Conductive 16A
4. CE ROHS certification
5. Fire prevention.V2



### Length

1000mm  
1500mm  
2000mm  
3000mm

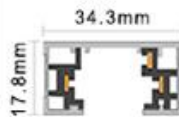

### Three Line Track system

1. Can be compatible with all major brands.
2. The contact area of flat copper is larger than round copper.
3. Conductive 16A
4. CE ROHS certification
5. Fire prevention.V2

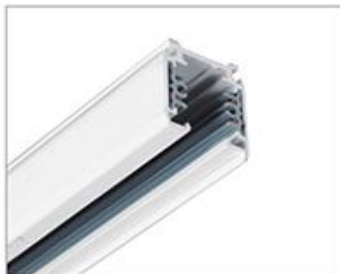

### Length

1000mm  
1500mm  
2000mm  
3000mm

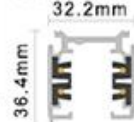

### Four-Wire Guide

1. Can be compatible with all major brands.
2. The contact area of flat copper is larger than round copper.
3. Conductive 16A
4. TUV CE ROHS certification
5. Fire prevention.V2



Dongguan Fitlight Lighting Co.,Ltd.

Add: 10th floor, building C1, Songhu Zhigu building, No. 9, Yanhe South Road, Liaobu Town, Dongguan City, Guangdong Province, China.

Email : [liu@fitlight-tech.com](mailto:liu@fitlight-tech.com) URL: [www.fitlight-tech.com](http://www.fitlight-tech.com) / <https://fitlight.en.alibaba.com>

## TRACK RAIL CONNECTION ACCESSORIES



I - Coupler



L - Coupler



T - Coupler



X - Coupler



Flexible Connector

Dongguan Fitlight Lighting Co.,Ltd.

Add: 10th floor, building C1, Songhu Zhigu building, No. 9, Yanhe South Road, Liaobu Town, Dongguan City, Guangdong Province, China.

Email : [liu@fitlight-tech.com](mailto:liu@fitlight-tech.com) URL: [www.fitlight-tech.com](http://www.fitlight-tech.com) / <https://fitlight.en.alibaba.com>



Dongguan Fitlight Lighting Co.,Ltd.

Add: 10th floor, building C1, Songhu Zhigu building, No. 9, Yanhe South Road, Liaobu Town, Dongguan City, Guangdong Province, China.

Email : [liu@fitlight-tech.com](mailto:liu@fitlight-tech.com) URL: [www.fitlight-tech.com](http://www.fitlight-tech.com) / <https://fitlight.en.alibaba.com>

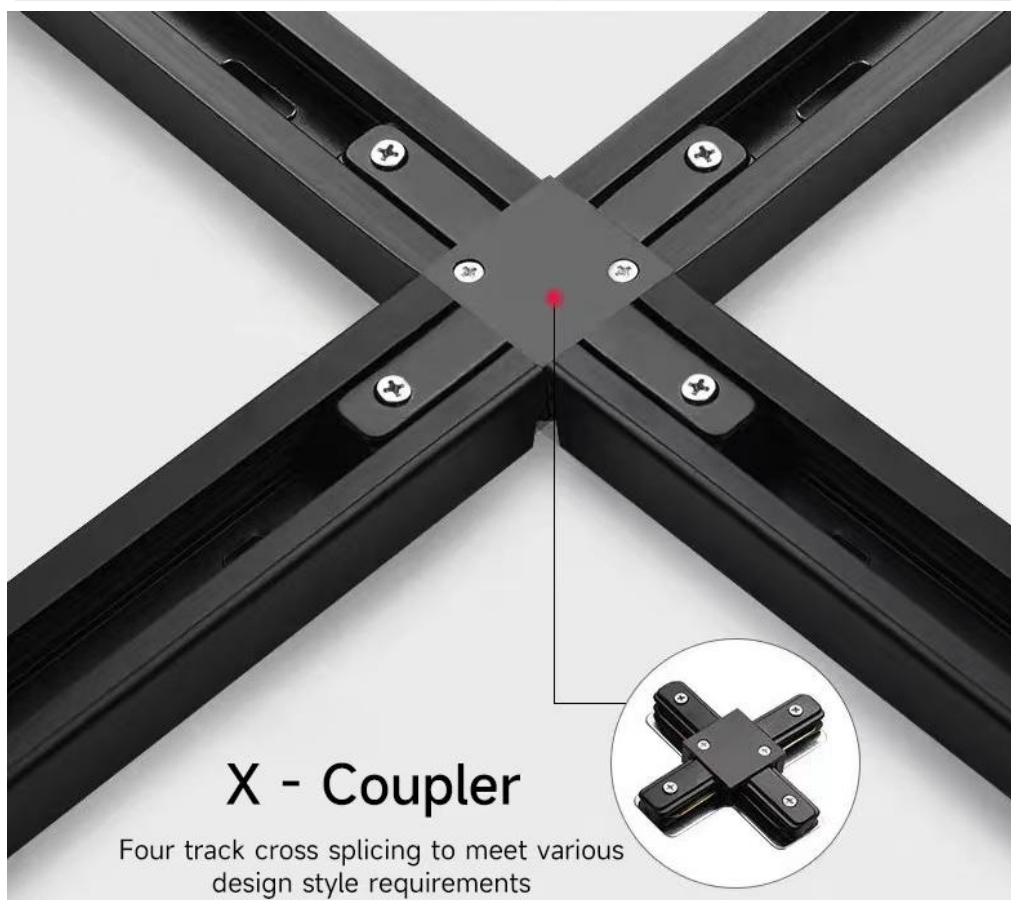
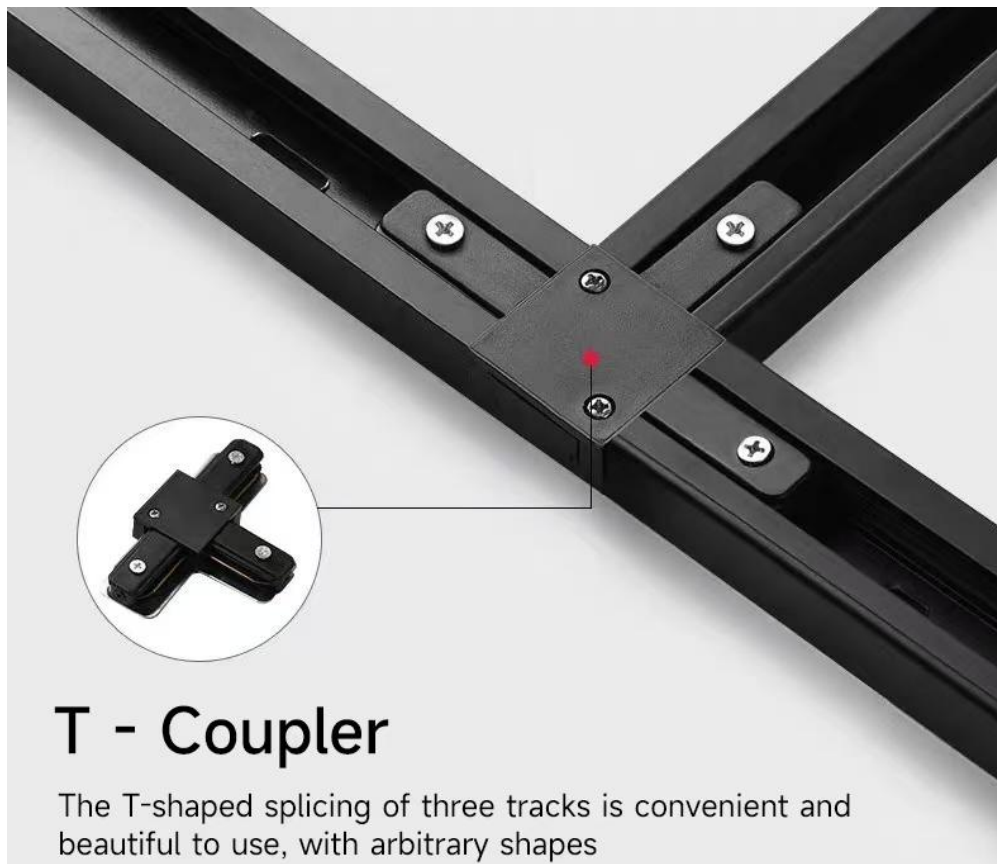

Dongguan Fitlight Lighting Co.,Ltd.

Add: 10th floor, building C1, Songhu Zhigu building, No. 9, Yanhe South Road, Liaobu Town, Dongguan City, Guangdong Province, China.

Email : [liu@fitlight-tech.com](mailto:liu@fitlight-tech.com) URL: [www.fitlight-tech.com](http://www.fitlight-tech.com) / <https://fitlight.en.alibaba.com>



Dongguan Fitlight Lighting Co.,Ltd.

Add: 10th floor, building C1, Songhu Zhigu building, No. 9, Yanhe South Road, Liaobu Town, Dongguan City, Guangdong Province, China.

Email : [liu@fitlight-tech.com](mailto:liu@fitlight-tech.com) URL: [www.fitlight-tech.com](http://www.fitlight-tech.com) / <https://fitlight.en.alibaba.com>

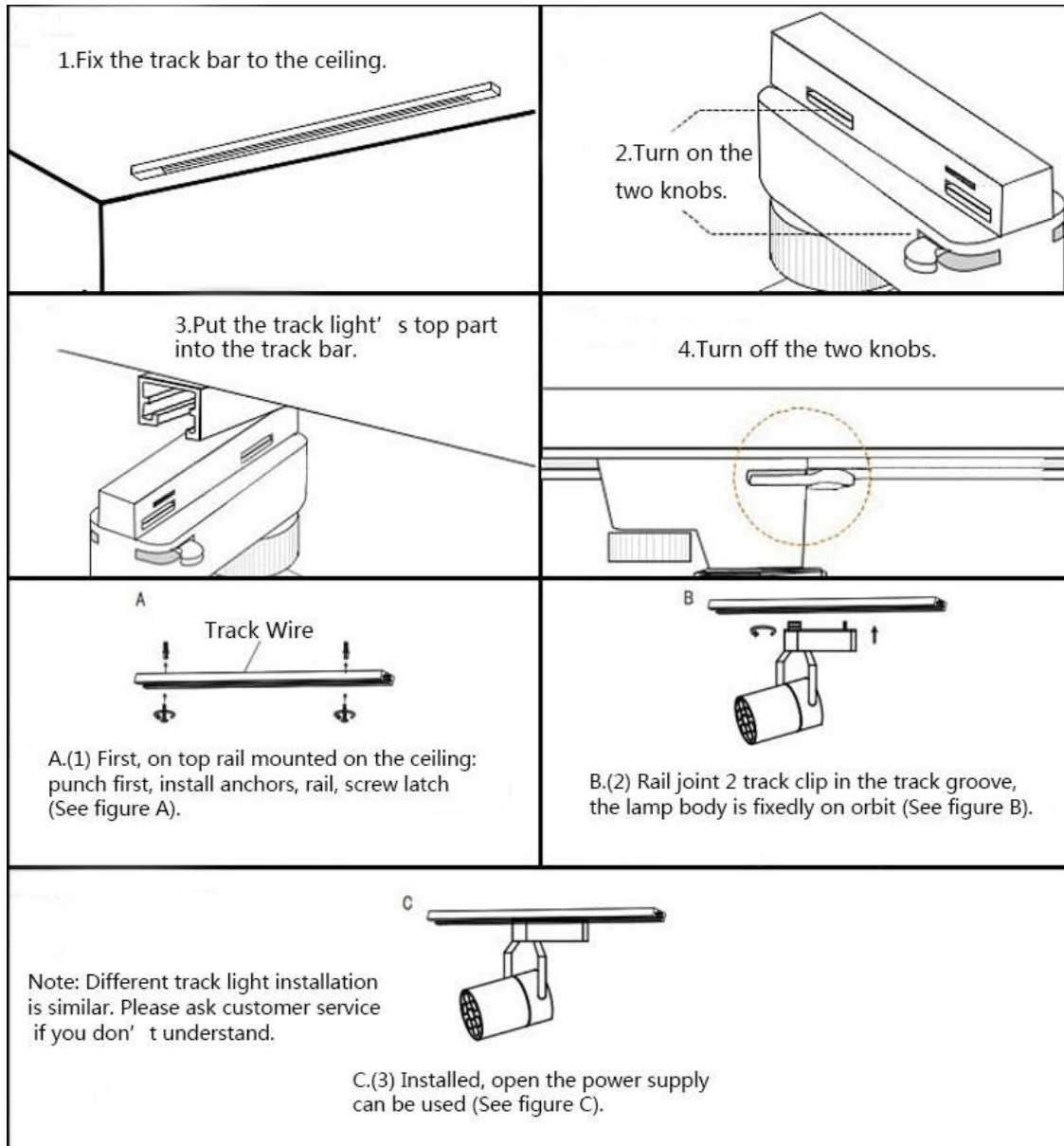

Dongguan Fitlight Lighting Co.,Ltd.

Add: 10th floor, building C1, Songhu Zhigu building, No. 9, Yanhe South Road, Liaobu Town, Dongguan City, Guangdong Province, China.

Email : [liu@fitlight-tech.com](mailto:liu@fitlight-tech.com) URL: [www.fitlight-tech.com](http://www.fitlight-tech.com) / <https://fitlight.en.alibaba.com>

## INSTALL APPLICATION

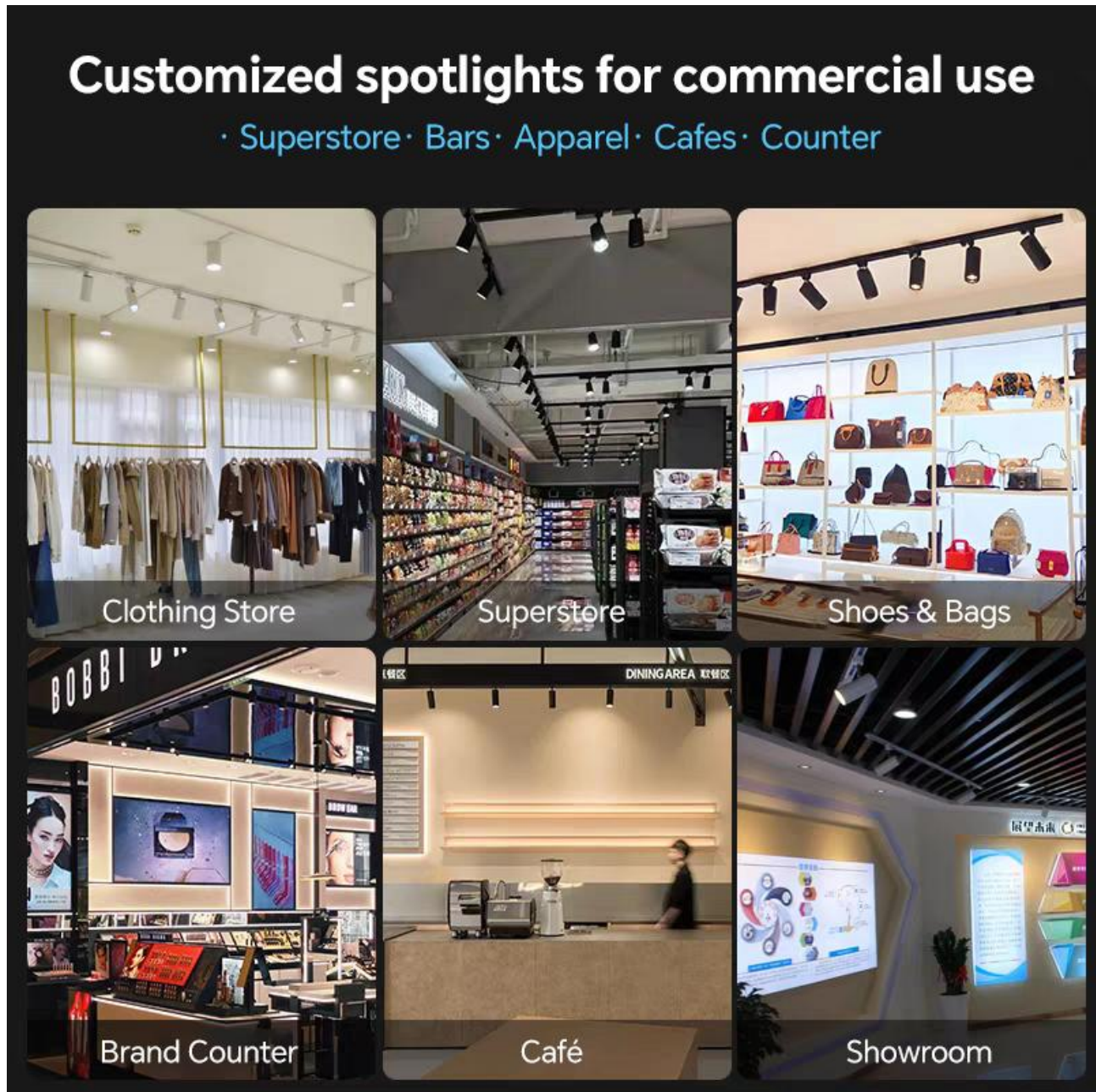

Dongguan Fitlight Lighting Co.,Ltd.

Add: 10th floor, building C1, Songhu Zhigu building, No. 9, Yanhe South Road, Liaobu Town, Dongguan City, Guangdong Province, China.

Email : [liu@fitlight-tech.com](mailto:liu@fitlight-tech.com) URL: [www.fitlight-tech.com](http://www.fitlight-tech.com) / <https://fitlight.en.alibaba.com>

## Caution:

- WARNING-Risk of fire or electric shock. LED Down light installation requires knowledge of luminaire electrical systems.
- If not qualified, do not attempt installation. Contact a qualified electrician.
- WARNING-To prevent wiring damage or abrasion, do not expose wiring to edges of sheet ; metal or other sharp objects.

## Hygiene & Safety

- Provide the illumination required in the work area for moving parts.
- We advise to use the soft cloth to clean up and do not attempt to use any chemical agent.
- In order to avoid any damages from the surface.
- Minimize the accumulation of dirt on the lamps and spotlights;
- For your safety, please cut off the power supply before changing or cleaning the lamp source.
- Facilitate maintenance.

Dongguan Fitlight Lighting Co.,Ltd.

Add: 10th floor, building C1, Songhu Zhigu building, No. 9, Yanhe South Road, Liaobu Town, Dongguan City, Guangdong Province, China.

Email : [liu@fitlight-tech.com](mailto:liu@fitlight-tech.com) URL: [www.fitlight-tech.com](http://www.fitlight-tech.com) / <https://fitlight.en.alibaba.com>