

Thanks for choosing our products, in order to protect your consumption right and personal safety, please read this instruction carefully before uses and keep this as the future reference.

Attention:

- Before installing the luminaire, please check whether the rated voltage of the luminaire is consistent with the voltage of the wiring power supply to avoid damage to the luminaire due to voltage inconsistency.
- Touching these parts without disconnecting the power supply may cause an electric shock. So, installation must be done by professional electrician.
- Please ensure the power has been cut off before installation, in order to prevent the electric shock, make sure the power supply that can't be resumed by anybody before the job done.
- Keep the surface of the lamp housing and transparent parts clean to ensure good light transmission.
- Plastic materials are used in some parts of the spotlight. Applying organic solvents (such as benzene), or other chemicals for cleaning may cause deformation or discolouration. Clean the device gently, using a soft dry cloth.
- Each fixing screw must be tightened when installing.
- The cable entry line should be fixed and prevented from pulling the wire and damaging the lamp.
- Avoid collision with hard objects to avoid scratches.
- Do not spray or pour water on the unit, this may cause an electric shock.
- Do not install the unit in locations subject to high and/or low temperatures (this may damage the LED lamp).
- The maintenance should be done by the professional. The luminaire must be grounded reliably and non-professionals must not disassemble the luminaire.
- The front-end power supply must be cut off during installation. The power supply must be cut off when repairing or replacing parts.
- The defective ballast could not be treated as the normal rubbish and should be returned and make use of the normal parts.
- Regarding the repair of the equipment contact Technical Support.

Dongguan Fitlight Lighting Co.,Ltd.

Add: 10th floor, building C1, Songhu Zhigu building, No. 9, Yanhe South Road, Liaobu Town, Dongguan City, Guangdong Province, China.

Email : liu@fitlight-tech.com URL: www.fitlight-tech.com / <https://fitlight.en.alibaba.com>

FEITL
 东莞市菲特莱照明有限公司
 DONGGUAN FITLIGHT LIGHTING CO.,LTD

OEM/ODM

Professional Lighting Product Manufacturer

- 1.14+ Years of Industry Leadership
- 2.Full Customization (OEM/ODM)
- 3.Certified Excellence: Globally recognized certifications (CE, RoHS, SAA, etc.)
- 4.Energy-Efficient & Sustainable Solutions
- 5.Competitive Pricing & Fast Turnaround
- 6.Dedicated R&D & Continuous Innovation

14^{+years}
 Production experience

3000^{+m²}
 Factory space

50⁺
 Patent certificate

100⁺
 Projects

10000^{+pcs}
 Daily output value

100⁺
 Service country



Dongguan Fitlight Lighting Co.,Ltd.

Add: 10th floor, building C1, Songhu Zhigu building, No. 9, Yanhe South Road, Liaobu Town, Dongguan City, Guangdong Province, China.

Email : liu@fitlight-tech.com URL: www.fitlight-tech.com / <https://fitlight.en.alibaba.com>

Features and Benefits

- Light source: COB LED
- Long LED life: More than 50,000 hours
- Low heat, less than 60°C
- No UV or IR light radiation
- No mercury or other inorganic
- Homogeneous flood illumination
- Machined aluminum heat fins with excellent thermal efficiencies
- The LED down light is available in the following white color temperatures: 2700/3000/3500/4000/5000/6000K
- 3 or 5 years limited warranty(3 years for Epistar LED chip model and 5 years for OSRAM LED chip version)
- Works with worldwide lighting systems 110VAC/220VAC



Typical Applications

- Spot lighting
- Retail Store lighting
- Commercial lighting
- Residential lighting
- General lighting
- Energy Saving Programs
- Sustainable Energy



ECO-Friendly



DC connector with Lock



Aluminum Heatsink



Brand Driver

Dongguan Fitlight Lighting Co.,Ltd.

Add: 10th floor, building C1, Songhu Zhigu building, No. 9, Yanhe South Road, Liaobu Town, Dongguan City, Guangdong Province, China.

Email : liu@fitlight-tech.com URL: www.fitlight-tech.com / <https://fitlight.en.alibaba.com>

PRODUCT SPECIFICATIONS

LAMP TYPE	Recessed Down Light GL02 Series
LIGHT SOURCE	Cree/OSRAM or Epistar COB LED (Other driver brands can also choose from)
Driver	Osram / Tridonic/ LIFUD (Other driver brands can also choose from)
Input voltage (volts)	AC 110V (± 10%)/AC 220V(± 10%)
Power	20W/25W/30W/35W/40W
BEAM ANGLE	15° /24° /36° /60° ±3°
RENDERING INDEX (Ra)	>90Ra
Material Quality	Aluminum
Color Temperature	Warm White(2700K/3000K/3500K) / Natural White(4000K) / Cool white(5000K/6000K)
Efficiency	85-90lm/w±10% for non-dimmable model; 80-85lm/w±10% for dimmable model; 100/110/120lm/w Can Be Customized
OPTICS	Aluminum coating reflector
HEATSINK	Machined pure aluminum with anodize finish
Installation	Recessed/Embedded
BASE TYPE	External Driver
DIMMABILITY	Dimmable(0-10V /Triac /Dali) / or Non-dimmable Model
Key Feature 1	Aluminum Cob Anti-glare Down Lights
Key Feature 2	Hotel / Residential Living Room Led Spotlight
Certification	CE/EMC/LVD/ROHS/SAA(Whole lamp);Driver(CE/EMC/LVD/ROHS/CB/SAA/UL)

ENVIRONMENTAL SPECIFICATIONS

TEMPERATURE RANGE	Ambient: -20°C to 40°C; Surface of Lamp: 60°C to 70°C
HUMIDITY RANGE	0 to 95% non-condensing humidity

PRODUCT CODE: FT-GL02-X₁/X₂

X1: Power

X2: LED chip(OSRAM / Cree or Epistar / bridgelux)

Dongguan Fitlight Lighting Co.,Ltd.

Add: 10th floor, building C1, Songhu Zhigu building, No. 9, Yanhe South Road, Liaobu Town, Dongguan City, Guangdong Province, China.

Email : liu@fitlight-tech.com URL: www.fitlight-tech.com / <https://fitlight.en.alibaba.com>

One lamp for multiple purposes

**IT'S BOTH A WALL WASHING LAMP
AND A CEILING LAMP**

Left and right swing adjustment



Dongguan Fitlight Lighting Co.,Ltd.

Add: 10th floor, building C1, Songhu Zhigu building, No. 9, Yanhe South Road, Liaobu Town, Dongguan City, Guangdong Province, China.

Email : liu@fitlight-tech.com URL: www.fitlight-tech.com / <https://fitlight.en.alibaba.com>

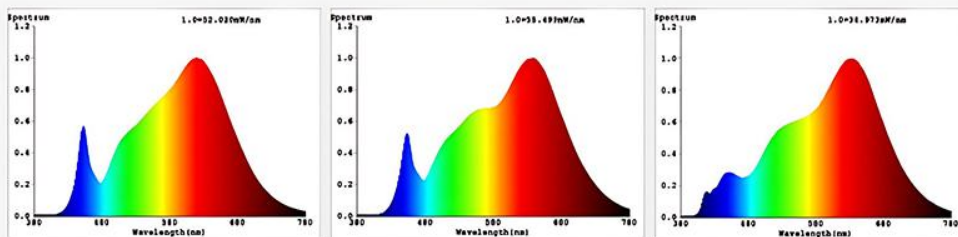

CRI90

CRI97

Sunlight

CCT option



Material Brand Cooperation

PHILIPS

CREE

OSRAM

EAGLE RISE

LIFUD

bridgelux

TRIDONIC

powered by

LUMINUS

EPISTAR

EOKE

KR
KERUI GROUP

CITILED®
The Light Engine

COB brand



OSRAM CREE Bridgelux

Other brands are also available

Power brand



Lifud Tridonic NOVBO Boke

Five-year warranty, no flicker PF > 0.9

Dongguan Fitlight Lighting Co.,Ltd.

Add: 10th floor, building C1, Songhu Zhigu building, No. 9, Yanhe South Road, Liaobu Town, Dongguan City, Guangdong Province, China.

Email : liu@fitlight-tech.com URL: www.fitlight-tech.com / <https://fitlight.en.alibaba.com>



Dongguan Fitlight Lighting Co.,Ltd.

Add: 10th floor, building C1, Songhu Zhigu building, No. 9, Yanhe South Road, Liaobu Town, Dongguan City, Guangdong Province, China.

Email : liu@fitlight-tech.com URL: www.fitlight-tech.com / <https://fitlight.en.alibaba.com>

ADJUSTABLE IRRADIATION ANGLE

The angle can be adjusted at will, no longer limited to the position of the light.
You can shine wherever you want



Dongguan Fitlight Lighting Co.,Ltd.

Add: 10th floor, building C1, Songhu Zhigu building, No. 9, Yanhe South Road, Liaobu Town, Dongguan City, Guangdong Province, China.

Email : liu@fitlight-tech.com URL: www.fitlight-tech.com / <https://fitlight.en.alibaba.com>



Dongguan Fitlight Lighting Co.,Ltd.

Add: 10th floor, building C1, Songhu Zhigu building, No. 9, Yanhe South Road, Liaobu Town, Dongguan City, Guangdong Province, China.

Email : liu@fitlight-tech.com URL: www.fitlight-tech.com / <https://fitlight.en.alibaba.com>

KNOWLEDGE POINT 2: HOW TO CHOOSE THE BEAM ANGLE

The illumination range of the 15 degree beam is relatively small, and it is generally used for key lighting with a soft 24 degree and 38 degree beam. It is generally used for wall washing and direct lighting with a 60 and 120 degree beam (simple lamp) that is vertically downward. It is generally used as auxiliary lighting

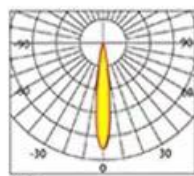

Beam angle: 15°

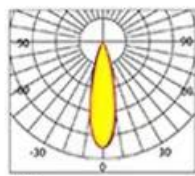

Beam angle: 24°

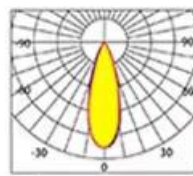

Beam angle: 38°

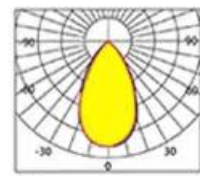

Beam angle: 60°



Beam angle 15°



Beam angle 24°



Beam angle 36°



Beam angle 60°

Dongguan Fitlight Lighting Co.,Ltd.

Add: 10th floor, building C1, Songhu Zhigu building, No. 9, Yanhe South Road, Liaobu Town, Dongguan City, Guangdong Province, China.

Email : liu@fitlight-tech.com URL: www.fitlight-tech.com / <https://fitlight.en.alibaba.com>

The higher the CRI, the better it can express the true color of the object

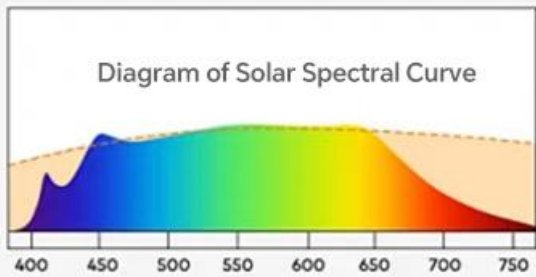

Our company's LED chips

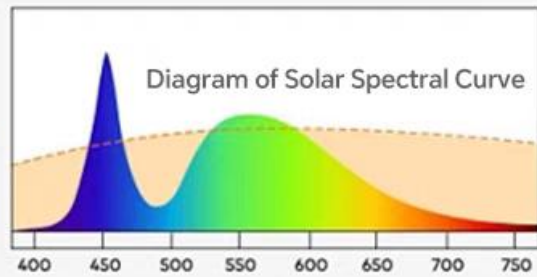

Ordinary LED chip



$Ra \geq 90$

Super high color reproduction ability
Really restore natural colors



$Ra \leq 80$

Color rendering index is low
Dull colors and blurry details

Dongguan Fitlight Lighting Co.,Ltd.

Add: 10th floor, building C1, Songhu Zhigu building, No. 9, Yanhe South Road, Liaobu Town, Dongguan City, Guangdong Province, China.

Email : liu@fitlight-tech.com URL: www.fitlight-tech.com / <https://fitlight.en.alibaba.com>

Product size



Dongguan Fitlight Lighting Co.,Ltd.

Add: 10th floor, building C1, Songhu Zhigu building, No. 9, Yanhe South Road, Liaobu Town, Dongguan City, Guangdong Province, China.

Email : liu@fitlight-tech.com URL: www.fitlight-tech.com / <https://fitlight.en.alibaba.com>

DIMMABLE

Single color dimmable



TRIAC



0-10V



DALI

2700-6000K tunable



2.4G

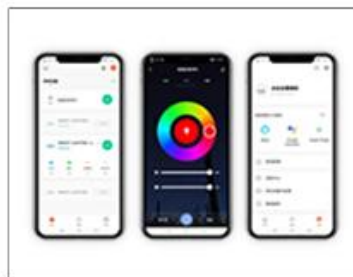

TUYA
(Bluetooth WiFi ZIGBEE)



DALI DT8

LED Down light Model at Ta=25°

Parameter	Symbol	Min	Type	Max	Unit
Input Voltage (AC)	V _{AC}	165	230	265	V
Estimated Life ^[*]		—	50,000	—	hours
Optimized Body Temperature	T	—	55	60	°C

Note[*] – Manufacturer projects Down Light made with COB LED to maintain an average of 70% lumens maintenance after 30,000 hours. This estimation is made based on data from LED manufacturer

Dongguan Fitlight Lighting Co.,Ltd.

Add: 10th floor, building C1, Songhu Zhigu building, No. 9, Yanhe South Road, Liaobu Town, Dongguan City, Guangdong Province, China.

Email : liu@fitlight-tech.com URL: www.fitlight-tech.com / <https://fitlight.en.alibaba.com>

Installation of Light with springs:

The installation method can be installed according to the installation diagram of the luminaire. The installation position of the luminaire is selected by the embedded installation, and the hanging parts, cables, installation tools, etc. required for installation are prepared. The luminaires are led out according to relevant specifications, and the luminaires are hanged by hanging parts, etc. The back cover is pre-selected and properly hung or embedded to the pre-selected position.

1. Make holes in the ceiling according to the size of the lamp .
2. Connect the power cord of the lamp with the reserved conductor .
3. The spring clips on both sides of the lamp shall be vertical, and the lamp shall be installed in the ceiling with holes.
4. After confirming the size of the opening and the fitting of the lamp, put down the spring buckle. After the installation of the lamp is completed, the power can be turned on for use.

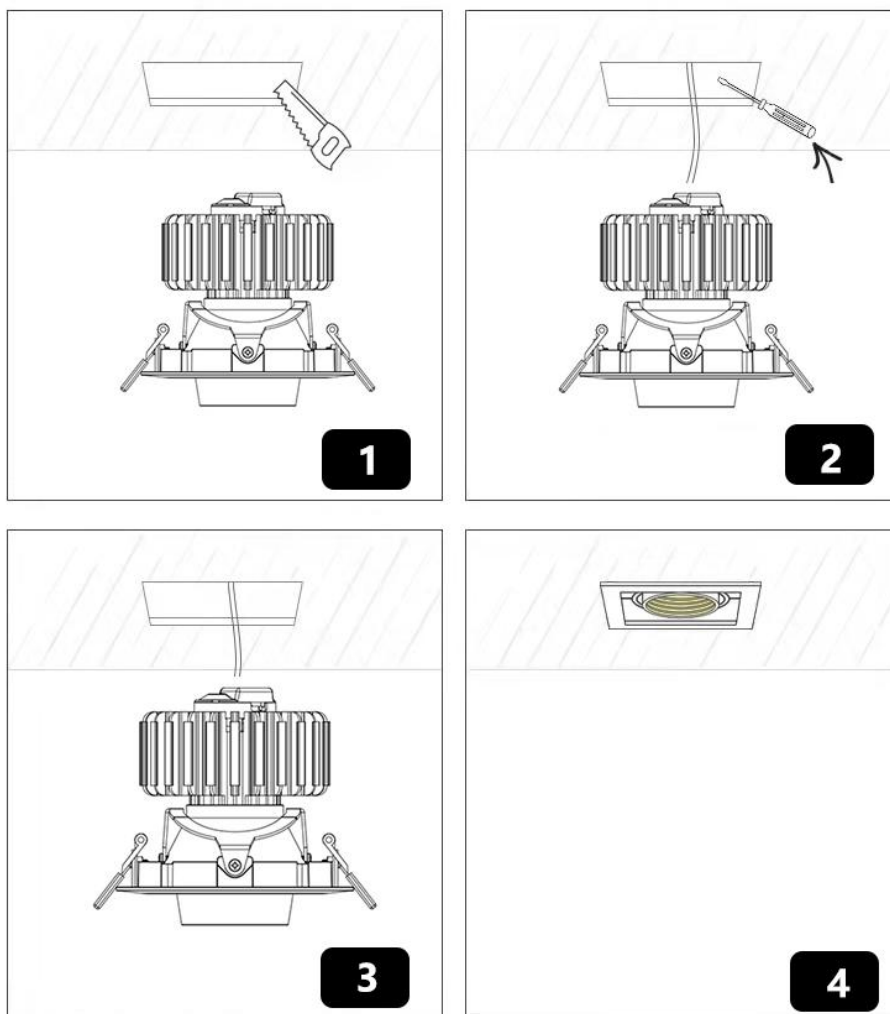

The front-end power supply must be cut off during installation. The power supply must be cut off when repairing or replacing parts.

Dongguan Fitlight Lighting Co.,Ltd.

Add: 10th floor, building C1, Songhu Zhigu building, No. 9, Yanhe South Road, Liaobu Town, Dongguan City, Guangdong Province, China.

Email : liu@fitlight-tech.com URL: www.fitlight-tech.com / <https://fitlight.en.alibaba.com>

INSTALL APPLICATION

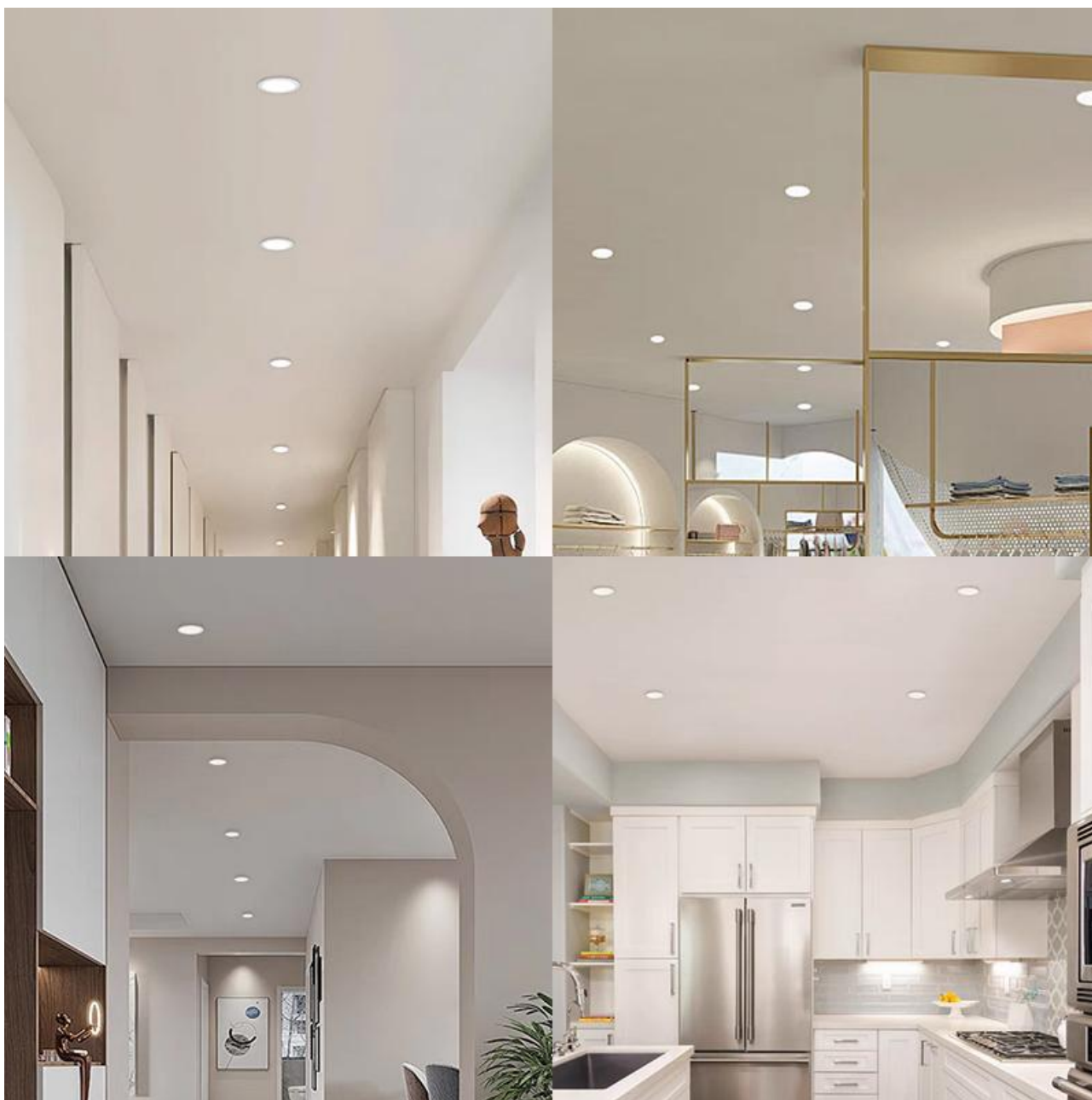

Dongguan Fitlight Lighting Co.,Ltd.

Add: 10th floor, building C1, Songhu Zhigu building, No. 9, Yanhe South Road, Liaobu Town, Dongguan City, Guangdong Province, China.

Email : liu@fitlight-tech.com URL: www.fitlight-tech.com / <https://fitlight.en.alibaba.com>

Standard Export packaging



Caution:

- WARNING-Risk of fire or electric shock. LED Down light installation requires knowledge of luminaire electrical systems.
- If not qualified, do not attempt installation. Contact a qualified electrician.
- WARNING-To prevent wiring damage or abrasion, do not expose wiring to edges of sheet ; metal or other sharp objects.

Hygiene & Safety

- Provide the illumination required in the work area for moving parts.
- We advise to use the soft cloth to clean up and do not attempt to use any chemical agent.
- In order to avoid any damages from the surface.
- Minimize the accumulation of dirt on the lamps and spotlights;
- For your safety, please cut off the power supply before changing or cleaning the lamp source.
- Facilitate maintenance.

Dongguan Fitlight Lighting Co.,Ltd.

Add: 10th floor, building C1, Songhu Zhigu building, No. 9, Yanhe South Road, Liaobu Town, Dongguan City, Guangdong Province, China.

Email : liu@fitlight-tech.com URL: www.fitlight-tech.com / <https://fitlight.en.alibaba.com>