

1/7

**CRYSTAL LABEL
GOLD/SILVER FOIL LABEL
PRINTER**





Crystal Sticker DTF UV Printer -EPSON i3200v1



• Bulk Ink Supply System

• LED Stripe

• Mute Rail

• Control Panel

• Transfer Film

• Glue Film Feeding System

• Take-up Motor

• LED UV Chiller

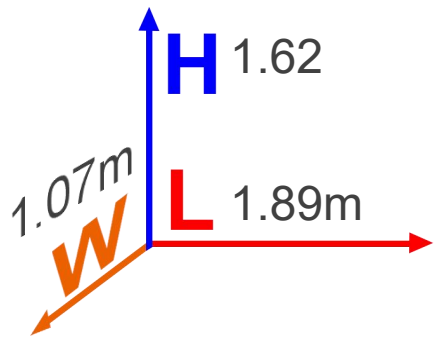
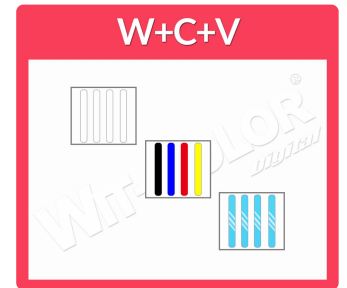

High Resolution	Variable Dots Technology	Environment Friendly	Energy Saving	Easy Operation	Continuous Printing	Professional Service

*Above information is for reference only, the exact configurations are subject to the order contract.

i3200 U1
UV

EPSON i3200 series print head is originally powered by EPSON Precision Core technology, VSTD technology supports gray scale printing, high resolution of 600 dpi and high durability. I3200 series: I means Innovation and new MEMS technology structure; 3200 means 3200 nozzles; **U1-U: UV, 1 means the first generation.**

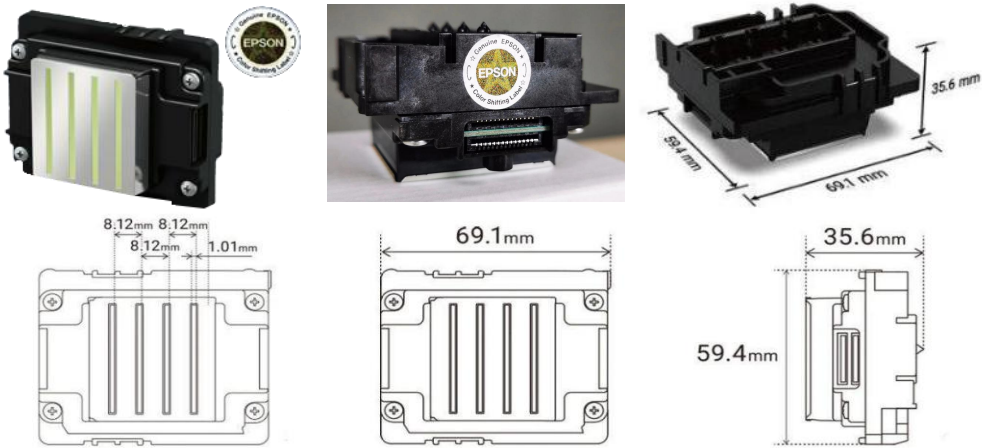

Product Specifications

Product name	I 3200-U1	I 3200-E1	I 3200-A1
Ink type	UV	Eco Solvent	Aqueous
Type	PrecisionCore MicroTFP printhead		
WidthxDepthxHeight	69.1x 59.4 x 35.6 mm		
Weight	82 g		
Number of nozzle	3200		
Nozzle pitch/nozzle row	1/300 inch		
Nozzle rows	8 rows		
Nozzle Resolution	300 npi /row 600 npi/2 rows		
Max. number of colour inks	4 colours		
Effective print width	33.8 mm (1.33 inches)		
Jetting frequency	43.2 kHz (Single mode)		
	21.6 kHz (Multi mode)		
Droplet volumes	5 pl (Single mode)		6 pl (Single mode)
	6, 12.5 pl (Multi mode)		6.3, 1 2.3 pl (Multi mode)
Viscosity range	5-7 mPa · s		3-4 mPa · s
Positioning Mechanism	Reference hole		

60cm UV Printer Side View for Crystal Effect Labels Application

Transfer film will be heated and pressed onto the printed images.

P.H.-WCV
UV Curing

Glue paper's protection film will be peeled off before printing.

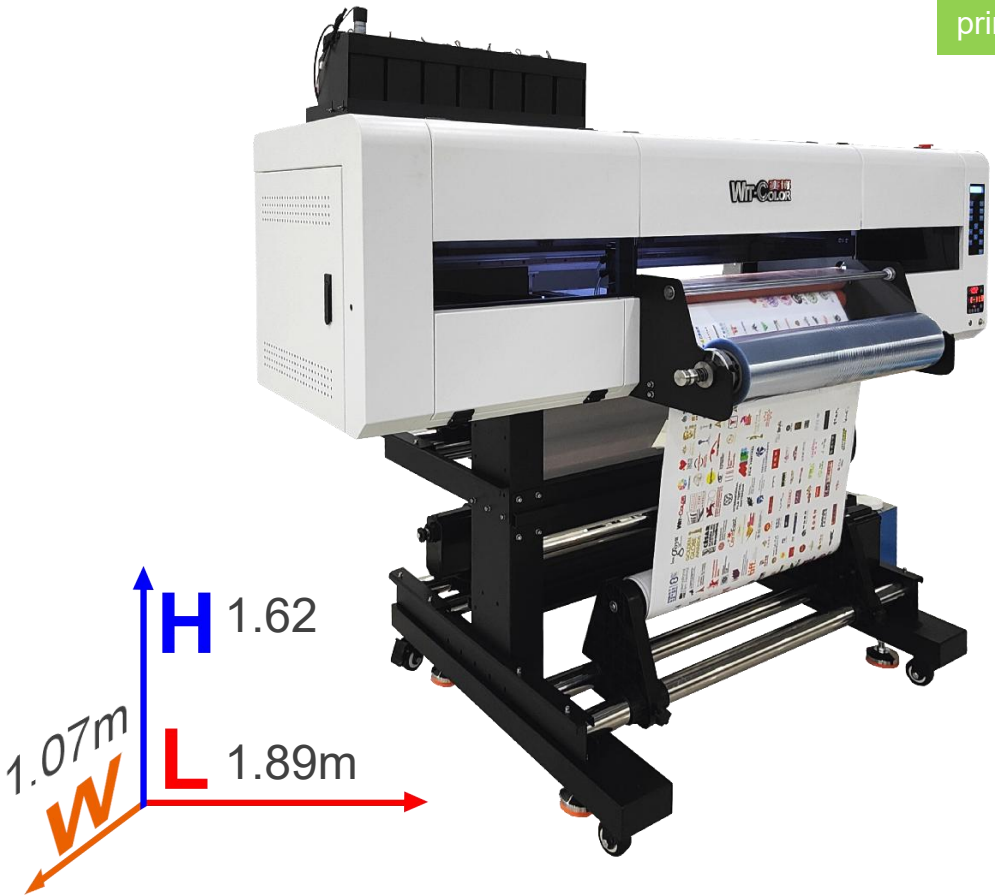
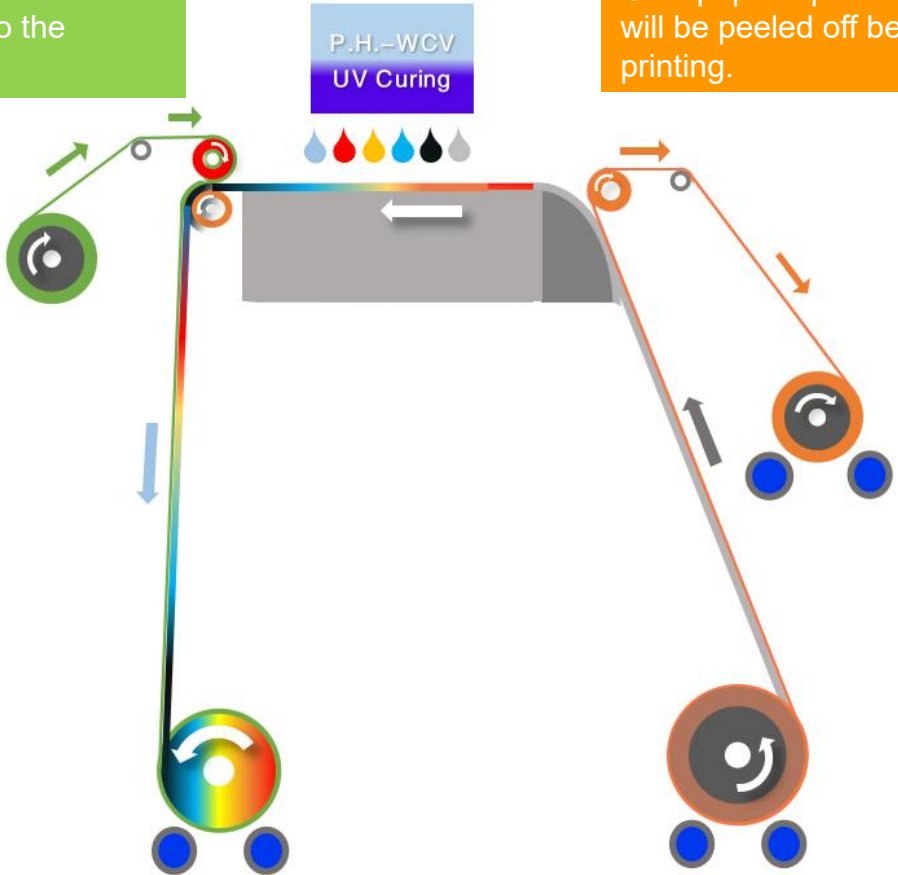

*Above information is for reference only, the exact configurations are subject to the order contract.

i3200 UV
Printer
White
+Color
+Varnish

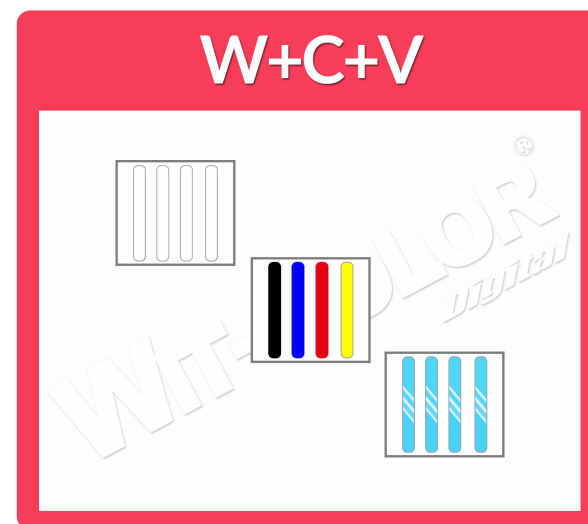

Printing Mode	White+Color+Varnish
Production Mode	12m ² /h
High Resolution Mode	5-8m ² /h

How to print the crystal effect labels by UV DTF Printer?

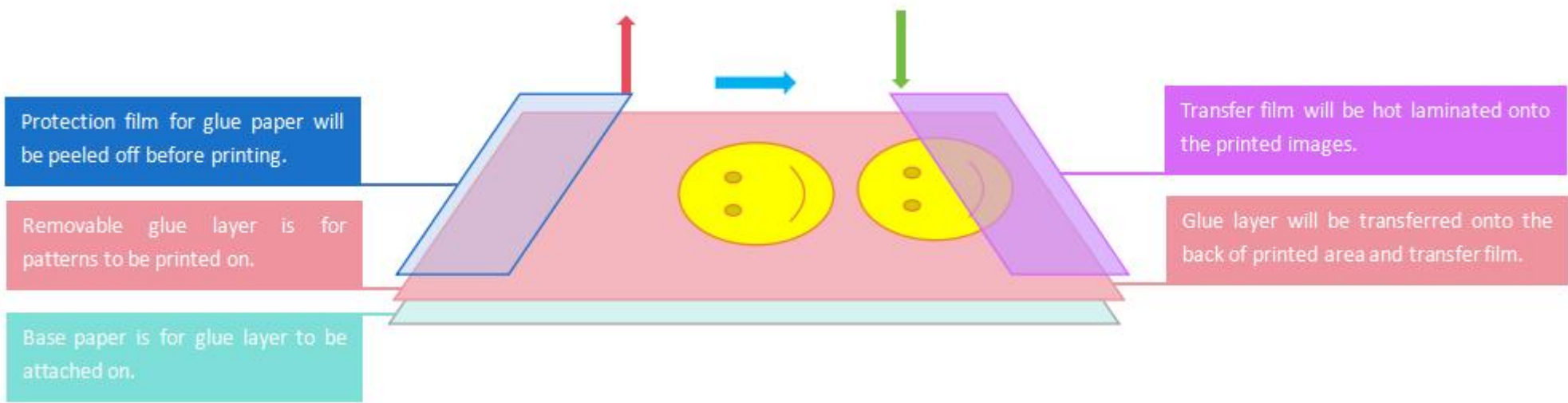

*Above information is for reference only, the exact configurations are subject to the order contract.

How to apply the crystal effect labels that printed by UV DTF Printer?

- Base Paper Layer
- Glue Layer
- Transfer Film Layer

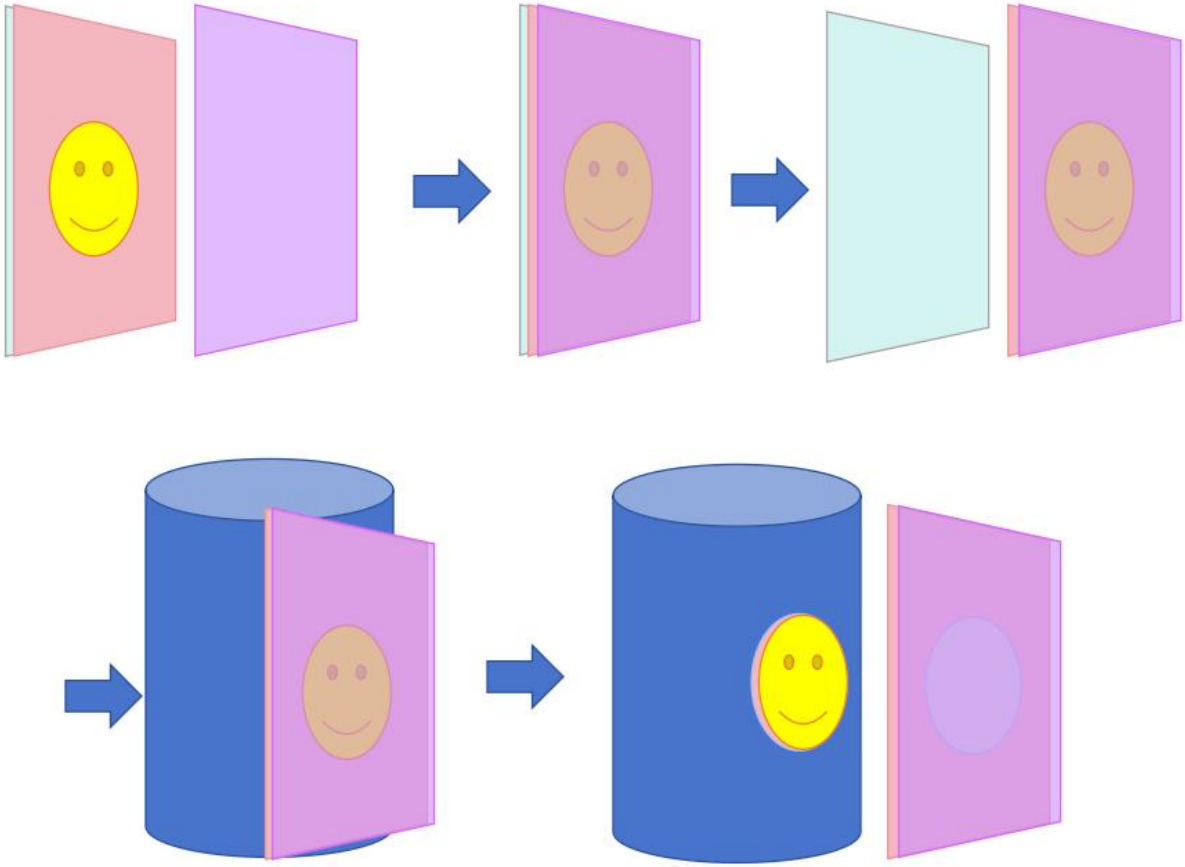

*Above information is for reference only, the exact configurations are subject to the order contract.

Protection
Film
for
glue
paper
will
be peeled off
before
printing



Transfer
film
will be
hot
laminated
onto the
printed
images



Thermal
Pressing
Roller
+
Heater
Cable

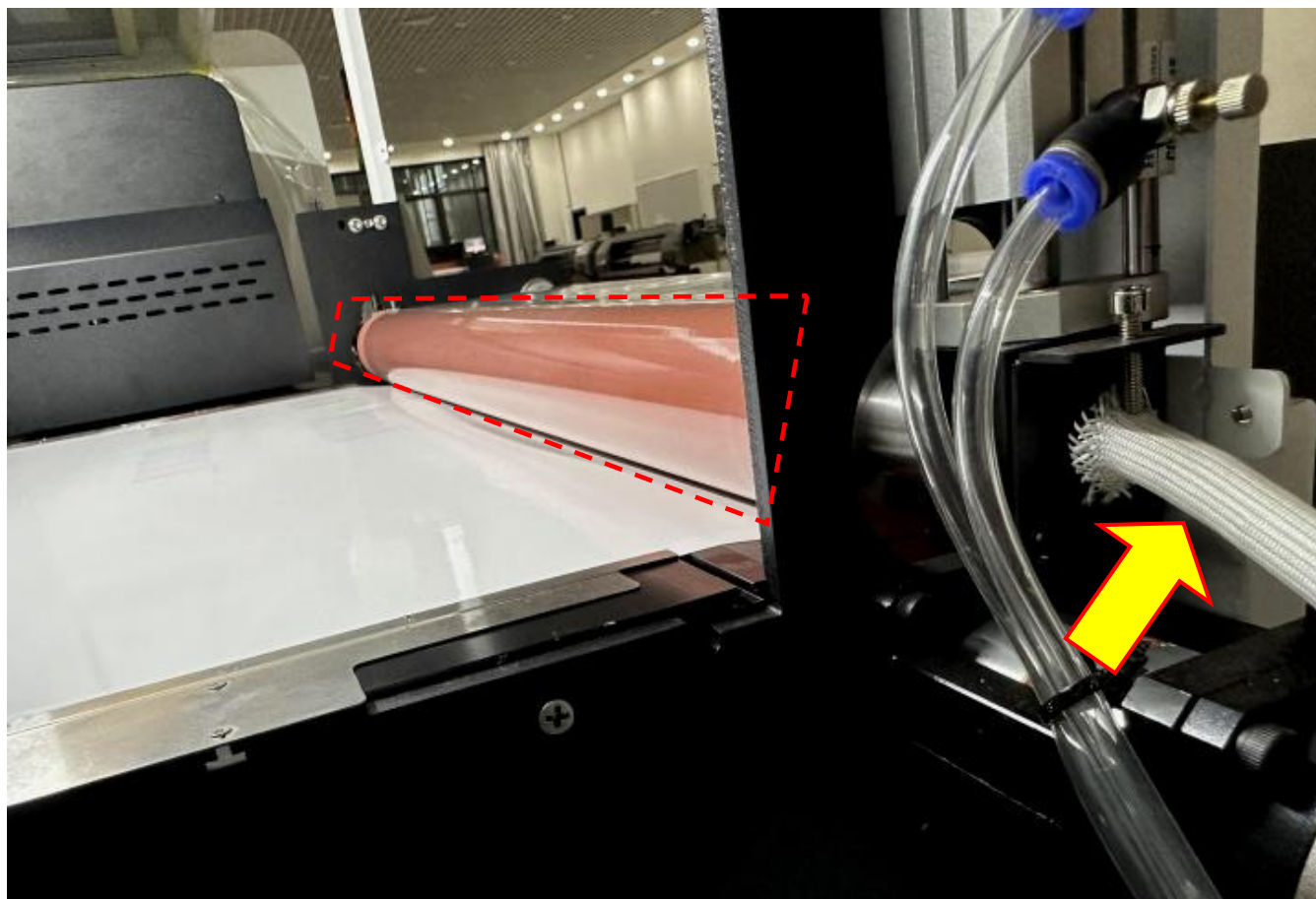

*Above information is for reference only, the exact configurations are subject to the order contract.

Peristaltic
[pə'ristæltɪk]
Pump
for
White Color
Ink
Recirculating

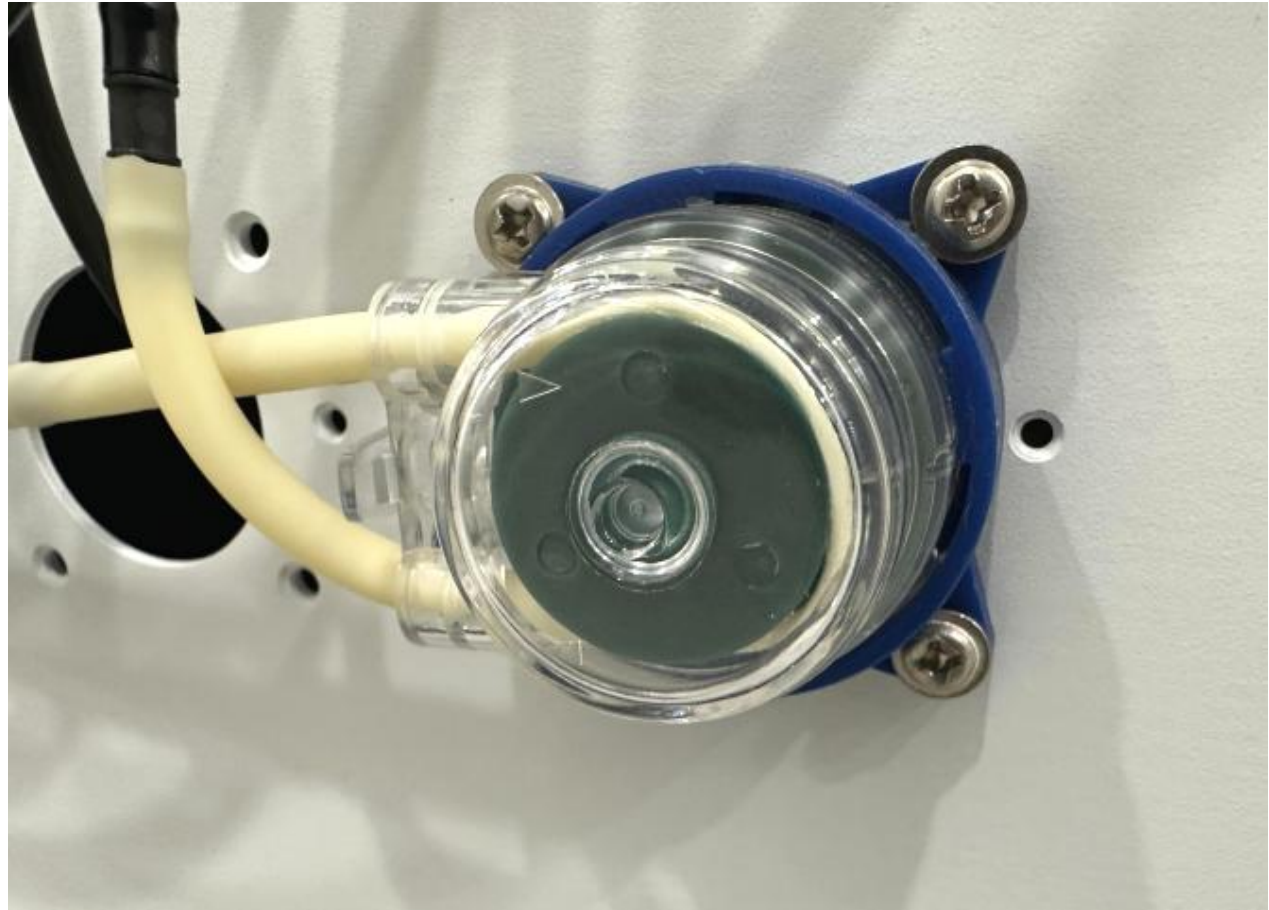

Motor
for
White
Color
Ink
Stirring



White Color Ink Stirring & Recirculation System Diagram

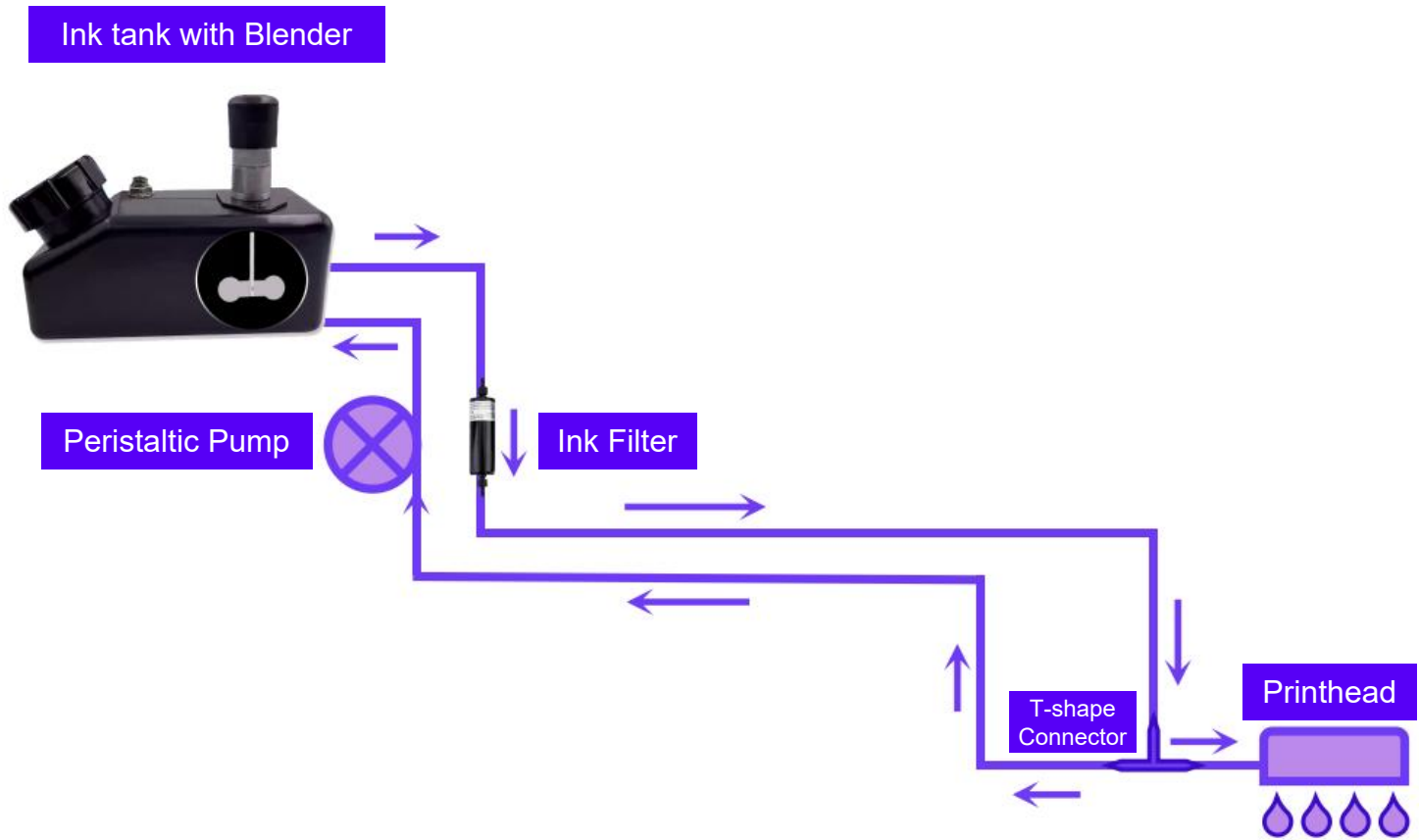

*Above information is for reference only, the exact configurations are subject to the order contract.

Mute
Linear
Rail
+
Optical
Strip



*Above information is for reference only, the exact configurations are subject to the order contract.

Printer Control Panel



*Above information is for reference only, the exact configurations are subject to the order contract.

Printer Control System



*Above information is for reference only, the exact configurations are subject to the order contract.

UV Crystal Labels Application



Gold/Silver Label Solution



60cm UV Printer Side View for Gold/Silver Lamination Effect Label Application

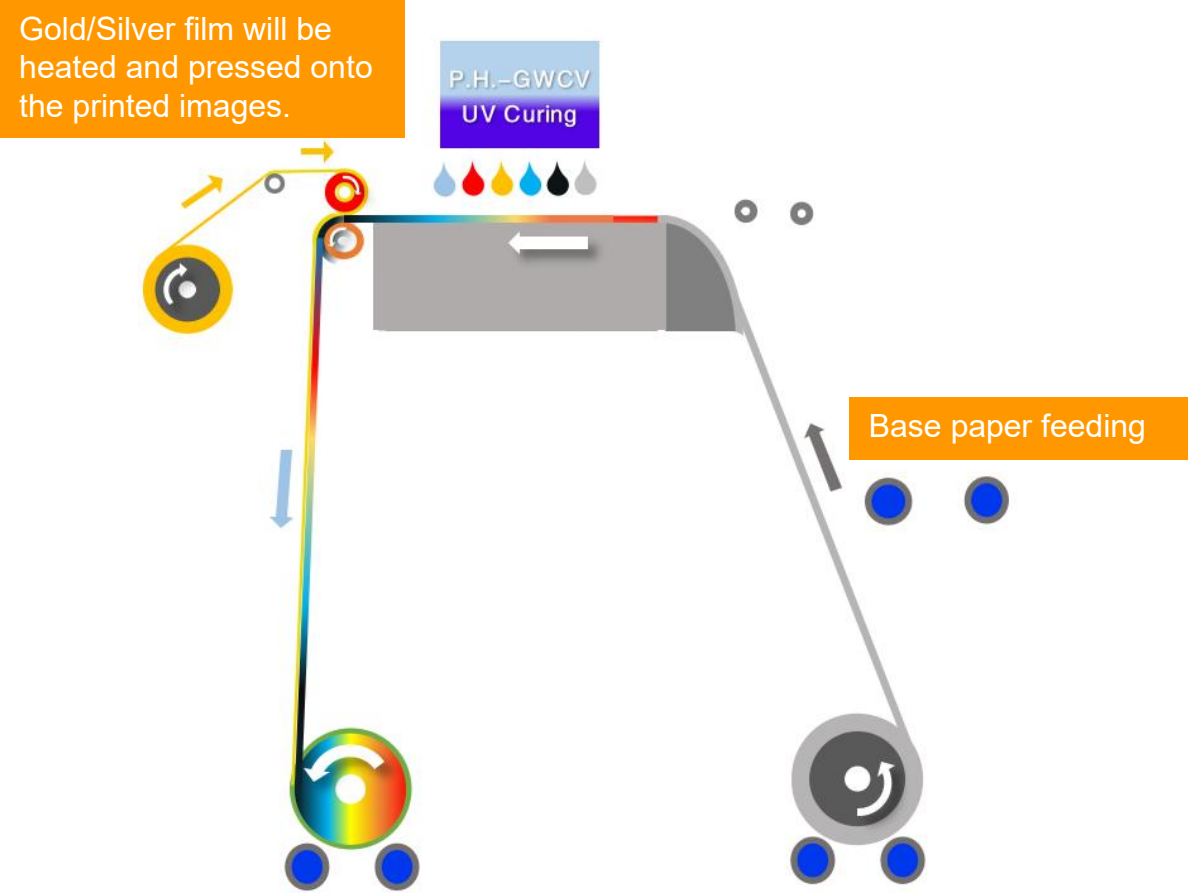
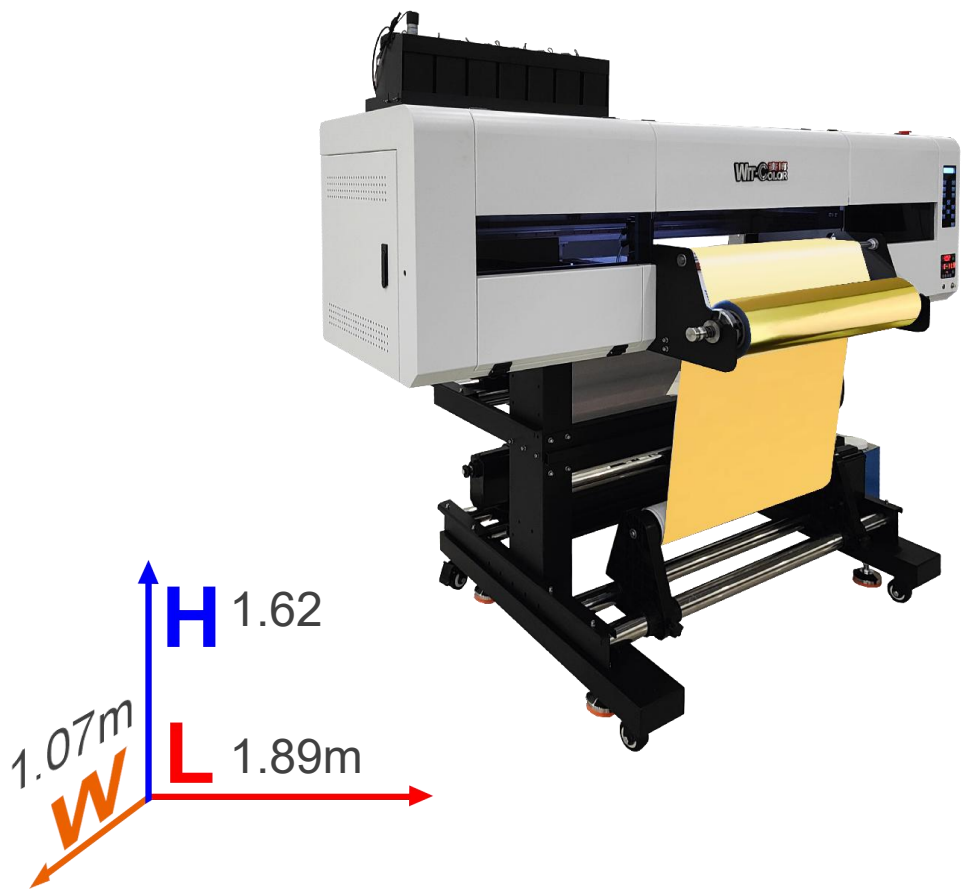

*Above information is for reference only, the exact configurations are subject to the order contract.

**i3200 UV
Printer
Glue+
White+
Color+
V1+V2**

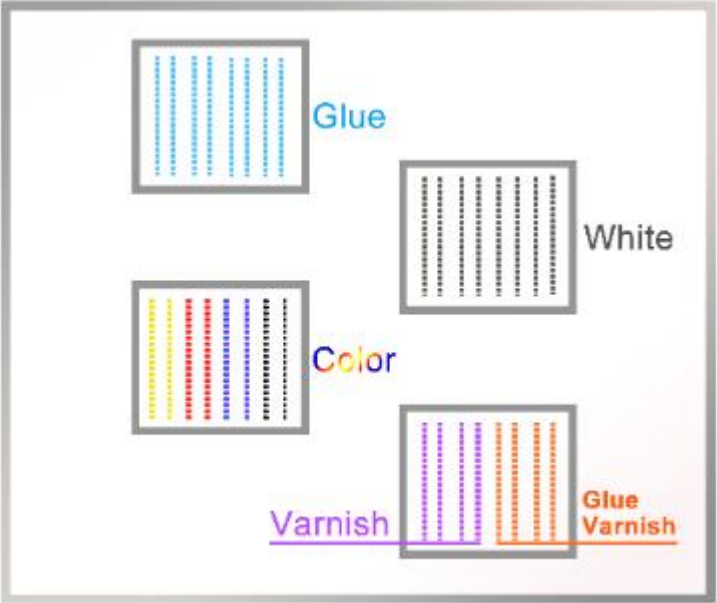

Printing Mode	Glue+White+Color+V1V2
Production Mode	12m ² /h
High Resolution Mode	5-8m ² /h

*Above information is for reference only, the exact configurations are subject to the order contract.

Three Effects could be realized in one printer



Full Color Crystal Label Effect



Full Color +Partial Gold Lamination Label Effect



Full Gold Lamination Label Effect

*Above information is for reference only, the exact configurations are subject to the order contract.