

# A20-T Series 2 Way UPVC Electric Ball Valve

# INSTRUCTION MANUAL



**dc DELCO**

Specialized Control Valve Manufacturer



## Introduction

The compact electric plastic ball valve adopts a ceramic core, which is wear-resistant, acid and alkali resistant, corrosion-resistant, highly resistant to scale, and has a long service life, widely replacing solenoid valves; The control methods for electric plastic ball valves are optional: two-line and three line control; Turn on/off the "power-off reset" function when powered on; Can set the opening and closing time of the switch; Quick opening and closing: 12.5s, 3s; Voltage: DC6V、12V、24V; 5. Optional: Thread/UPVC socket adhesive. Using ceramic balls as the sealing core component, it is wear-resistant, corrosion-resistant, has excellent sealing performance, strong anti scaling ability, and has a long service life

## Main Parts Materials

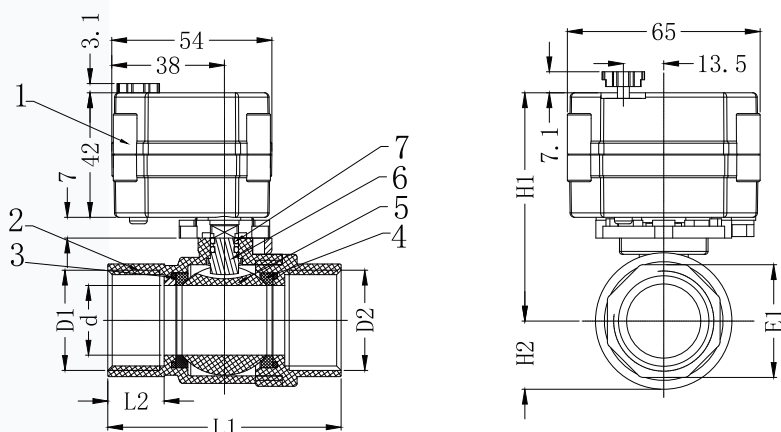

UNIT:mm

NO.	Name	Material
01	Actuator	PPO
02	Body & Cover	UPVC
03	O-Ring	EPDM
04	Sealing	PTFE
05	Sealing	UPVC
06	Ball	UPVE+SS304
07	Gasket	EPDM

## Dimension

DESCRIPTION	D1/D2	d±0.3	L1±1	L2±1	E1±0.5	H1±1	H2
15-P2-B	1/2"	14	60	12	29.5	76.3	19.5
20-P2-B	3/4"	17	73	17	37	78	22
25-P2-B	1"	23	80	18	43.5	83	26.5
32-P2-B	1 1/4"	26	94.5	23	50	82	28

## Technical Parameters

Product Size	NPT/BSP/NO Thread Glued Type 1/2" 3/4" 1" 1 1/4"1" (optional)
Maximum Working Pressure	1.0 MPa
Circulation Medium	Fluid, air
Working Voltage	DC5V、DC12V、DC24V、DC/AC9-24V、AC/DC110-230V
Working Diagram	CR201 CR202 CR301 CR302 CR303 CR304 CR305 CR306 CR501 CR502 CR701 CR702 CR703 CR705 CR706(Optional)
Working Current	≤500mA
Open/Close Time	≤7S
Life Time	70000 times (testing pressure is 0.4MPa, medium is water)
Valve Body Material	UPVC
Actuator Material	PPO
Sealing Material	FKM & PTFE
Actuator Rotation	90°
Torque Force	3N.m
Cable Length	0.5m ,1.5m(Optional)
Environment Temperature	-15°C ~ 50°C
Liquid Temperature	5°C ~ 55°C
Manual Override	Yes No (Optional)
Open/Close Indicator	Yes No (Optional)
Protection Class	IP67

## Actuator Model



## Naming Scheme For Electric Ball Valve

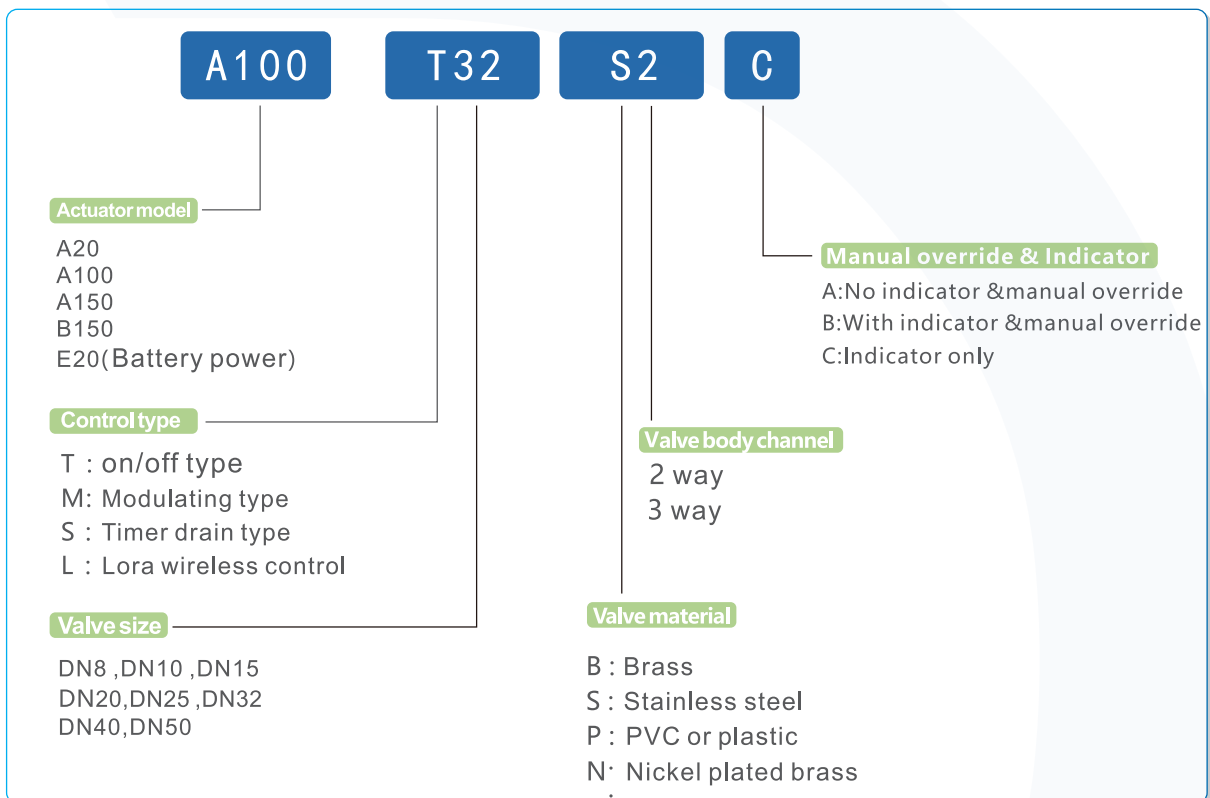

## Manual Operation Instruction

- The manual function can only use in the power failure situation
- Lift the manual knob and confirm the direction of rotation. The valve is opened in the direction of "O" and closed in the direction of "S". Stop rotating after observing the indication mark in place.
- Press the handwheel after manual operation ,otherwise the gear will be damaged



Manual Operation Instruction

## Wiring Diagram

### CR 201 Wiring Diagram ( 2 Wires Control )

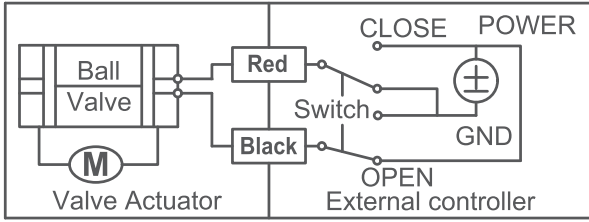

- Red connect with positive, the Black connect with negative, the valve closed, the actuator automatically power off after in place , the valve remains fully closed position
- Black connect with positive, the Red connect with negative, the valve open, the actuator automatically power off after in place, the valve remains fully open position
- \* Suitable Working Voltage: DC5V,DC12V,DC24V
- \* Exceeding the working voltage is forbidden

### CR 202 Wiring Diagram ( 2 Wires Control-Capacitors return in of the power is failure )

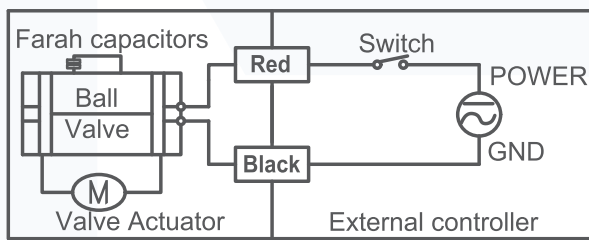

- When SW is closed , the valve OPEN. the actuator automatically power off after in place
- When SW is open, the valve CLOSED, the actuator automatically power off after in place
- \* Suitable Working Voltage: AC/DC9-24V AC/DC110-230V
- \* Exceeding the working voltage is forbidden

### CR 301 Wiring Diagram ( 3 Wires Control )

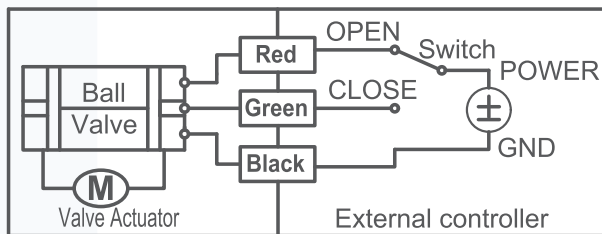

- Red & Green connect with positive, Black connect with negative
- When OPEN( Red ) & SW connected , the valve OPEN, the actuator automatically power off after in place , valve remains fully open position
- When CLOSE(Green ) & SW connected, the valve CLOSED, the actuator automatically power off after in place, valve remains fully closed position
- \* Suitable Working Voltage: DC5V,DC12V,DC24V
- \* Exceeding the working voltage is forbidden

### CR 302 Wiring Diagram ( 3 Wires Control )

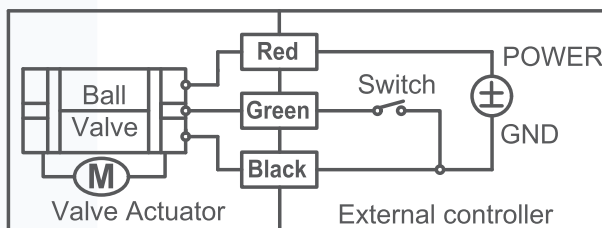

- Red connect with positive, the Black & Green connect with negative
- SW CLOSED, the valve OPEN, the actuator automatically power off after in place
- SW OPEN, the valve CLOSED, the actuator automatically power off after in place
- \* Suitable Working Voltage: DC9-24V
- \* Exceeding the working voltage is forbidden

### CR 303 Wiring Diagram ( 3 Wires Control )

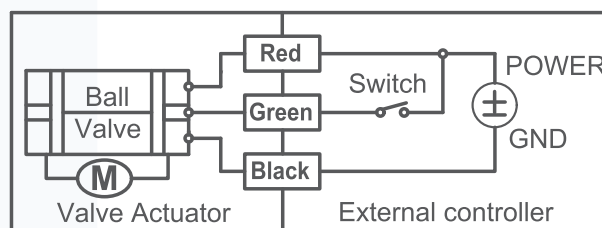

- Red & Green connect with positive, the Black connect with negative
- SW CLOSED, the valve OPEN, the actuator automatically power off after in place
- SW OPEN, the valve CLOSED, the actuator automatically power off after in place
- \* Suitable Working Voltage: DC12V,DC24V,AC/DC9-24V,AC/DC110-230V,AC/DC9-29V
- \* Exceeding the working voltage is forbidden

## Wiring Diagram

### CR 304 Wiring Diagram ( 3 Wires Control )

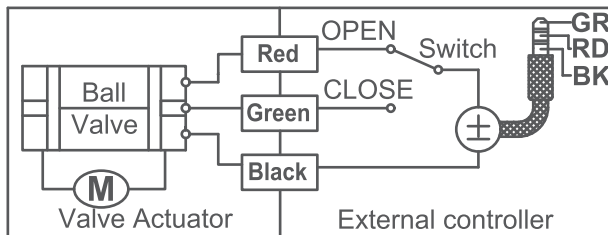

- Red & Green connected with positive, and the Black connected with negative
- When Red & SW connected, the valve closed, the actuator automatically power off after in place , remains fully closed position
- When Green & SW connected, the valve open, the actuator automatically power off after in place , remains fully open position
- \* Suitable Working Voltage: DC5V,DC12V, DC9-24V
- \* Exceeding the working voltage is forbidden

### CR 305 Wiring Diagram ( 3 Wires Control-Capacitors return incase of the power is failure )

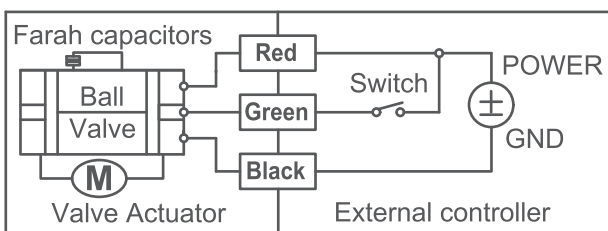

- Red & Green connect with positive, the Black connect with negative
- SW CLOSED, the valve OPEN, the actuator automatically power off after in place
- SW OPEN, the valve CLOSED, the actuator automatically power off after in place
- When external power off, the valve CLOSED, the actuator automatically power off after in place
- \* Suitable Working Voltage: AC/DC9-24V,AC/DC110-230V
- \* Exceeding the working voltage is forbidden

### CR 306 Wiring Diagram ( 3 Wires Control-Capacitors return in case of the power is failure )

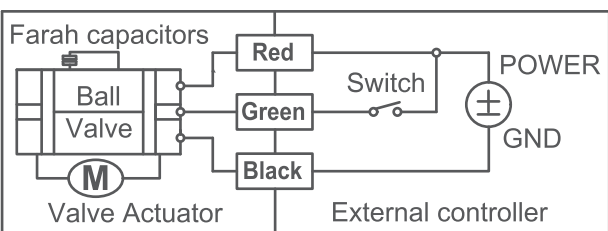

- Red & Green connect with positive, the Black connect with negative
- SW CLOSED, the valve OPEN, the actuator automatically power off after in place
- SW OPEN, the valve CLOSED, the actuator automatically power off after in place
- When external power off, the valve OPEN, the actuator automatically power off after in place
- \* Suitable Working Voltage: AC/DC9-24V,AC/DC110-230V
- \* Exceeding the working voltage is forbidden

### CR 401 Wiring Diagram ( 4 Wires Control )

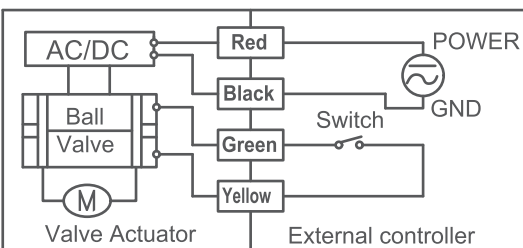

- Red & Black are connected to the power, Green & Yellow are connected to the controlled wiring
- When the SW is closed , the valve open
- When the SW is OPEN , the valve CLOSED Suitable Working Voltage:AC/DC110V-230V
- Exceeding the working voltage is forbidden
- The control wiring with power DC5V , when multiple motorized valves are working in paralld , must put the same color control wiring together, otherwise the valve could not working normally

### CR 501 Wiring Diagram ( 5 Wires Control with feedback signal )

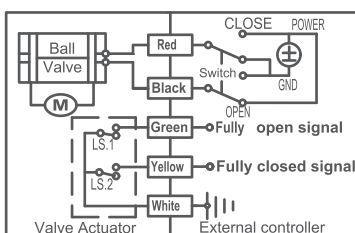

- Red connect with positive, the Black connect with negative, the valve closed, the actuator automatically power off after in place
- Black connect with positive, the Red connect with negative, the valve open, the actuator automatically power off after in place
- Green & White connect with the valve's fully open signal wiring
- Yellow & White connect with the valve's fully closed signal wiring
- Suitable Working Voltage:DC5V,DC12V,DC24V
- Exceeding the working voltage is forbidden

## Wiring Diagram

### CR 502 Wiring Diagram ( 5 Wires Control-Capacitors return in case of the power is fallure & feedback signal )

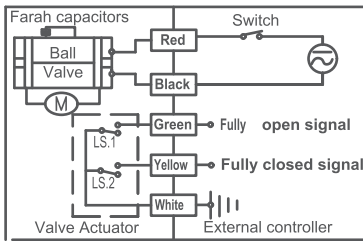

- When SW is closed , the valve OPEN. the actuator automatically power off after in place
- When SW is open, the valve CLOSED, the actuator automatically power off after in place
- Green & White connect with the valve's fully open signal wiring
- Yellow & White connect with the valve's fully closed signal wiring
- Suitable Working Voltage: AC/DC9-24V, AC/DC110V-230V
- Exceeding the working voltage is forbidden

### CR 602 Wiring Diagram ( 6 Wires Control with feedback signal )

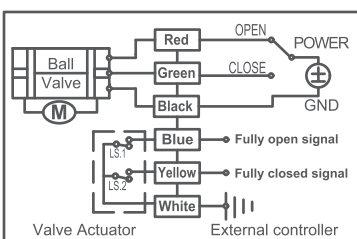

- Red & Green connect with positive, the Black connect with negative
- When Red & SW connected, the valve OPEN, the actuator automatically power off after the valve fully open
- When Green & SW connected, the valve CLOSED, the actuator automatically power off after the valve fully closed
- Blue & White connect with the valve's fully open signal wiring
- Yellow & White connect with the valve's fully closed signal wiring
- Suitable Working Voltage: ,DC12V,DC24V AC24V DC12-24V
- Exceeding the working voltage is forbidden

### CR 603 Wiring Diagram ( 6 Wires Control with feedback signal )

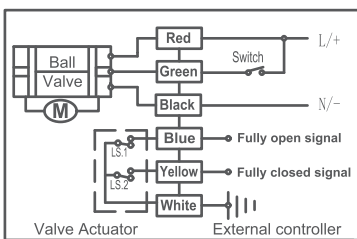

- Red & Green connect with positive, the Black connect with negative
- SW CLOSED, the valve OPEN, the actuator automatically power off after in place
- SW OPEN, the valve CLOSED, the actuator automatically power off after in place
- Blue & White connect with the valve's fully open signal wiring
- Yellow & White connect with the valve's fully closed signal wiring
- Suitable Working Voltage: DC12V, DC24V
- Exceeding the working voltage is forbidden
- Feedback signal load capacity: 1, voltage: DC0-35V, 2, the maximum current is 0.4A.

### CR 701 Wiring Diagram ( 7 Wires Control with feedback signal )

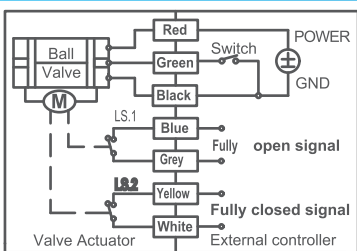

- Red connect with positive
- Green connect with SW and negative wiring
- Black connect with negative wiring
- When SW close. the valve OPEN, and keeping fully open
- When SW open. the valve CLOSED, and keeping fully closed
- Blue & Grey connect with the valve's fully open signal wiring
- Yellow & White connect with the valve's fully closed signal wiring
- Suitable Working Voltage: DC9-24V
- Exceeding the working voltage is forbidden
- Feedback with load ability:
- ①The Max. off voltage: DC36V AC220V

### CR 702 Wiring Diagram ( 7 Wires Control with feedback signal )

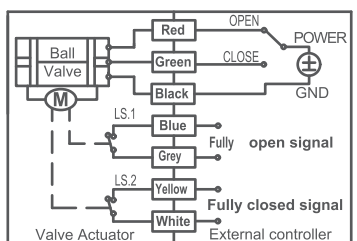

- Red & Green connect with positive, the Black connect with negative
- When Red & SW connected, the valve OPEN, the actuator automatically power off after the valve fully open
- When Green & SW connected, the valve CLOSED, the actuator automatically power off after the valve fully closed
- Blue & Grey connect with the valve's fully open signal wiring
- Yellow & White connect with the valve's fully closed signal wiring
- Suitable Working Voltage: DC5V,DC12V,DC24V
- Exceeding the working voltage is forbidden
- Feedback with load ability:
- ① The Max. off voltage: DC36V AC220V
- ② The Max. off current: ≤0.4A

## Wiring Diagram

### CR 703 Wiring Diagram ( 7 Wires Control with feedback signal )

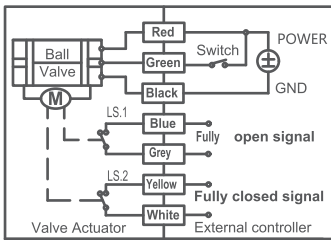

- Red & Green connect with positive, the Black connect with negative
- SW CLOSED, the valve OPEN, the actuator automatically power off after in place
- SW OPEN, the valve CLOSED, the actuator automatically power off after in place
- Blue & Grey connect with the valve' s fully open signal wiring
- Yellow & White connect with the valve' s fully closed signal wiring
- Suitable Working Voltage: DC12V,DC24V,AC/DC9-24V,AC110-230V
- Exceeding the working voltage is forbidden

### CR704 Wiring Diagram ( 7 Wires Control with feedback signal )

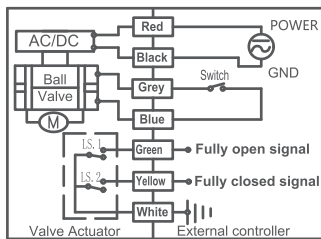

- Red & Black are connected to the power, Blue & Grey are connected to the controlled wiring
- When the SW is closed , the valve open
- When the SW is open , the valve closed
- Green & White connect with the valve's fully OPEN signal wiring
- Yellow & White connect with the valve's fully CLOSED signal wiring
- Suitable Working Voltage: AC/DC110V-230V
- Exceeding the working voltage is forbidden

### CR705 Wiring Diagram ( 7 Wires Control-Capacitors return in case of the power is failure & feedback signal )

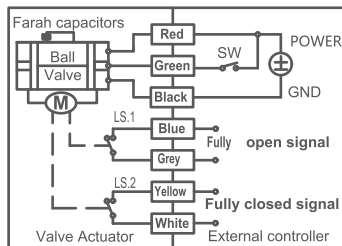

- Red & Green connect with positive, the Black connect with negative
- SW CLOSED, the valve OPEN, the actuator automatically power off after in place
- SW OPEN, the valve CLOSED, the actuator automatically power off after in place
- When external power off, the valve **closed**, the actuator automatically power off after in place
- Blue & Grey connect with the valve's fully open signal wiring
- Yellow & White connect with the valve's fully closed signal wiring
- Suitable Working Voltage: AC/DC9-24V,AC/DC110-230V
- Exceeding the working voltage is forbidden

### CR706 Wiring Diagram ( 7 Wires Control Capacitors return in case of the power is failure & feedback signal )

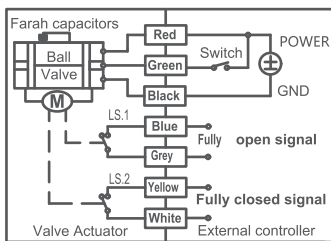

- Red & Green connect with positive, the Black connect with negative
- SW CLOSED, the valve OPEN, the actuator automatically power off after in place
- SW OPEN, the valve CLOSED, the actuator automatically power off after in place
- When external power off, the valve **open**, the actuator automatically power off after in place
- Blue & Grey connect with the valve's fully open signal wiring
- Yellow & White connect with the valve's fully closed signal wiring
- Suitable Working Voltage: AC/DC9-24V,AC/DC110-230V
- Exceeding the working voltage is forbidden

### A150 SERIES MODULATING VALVE WIRE DIAGRAM

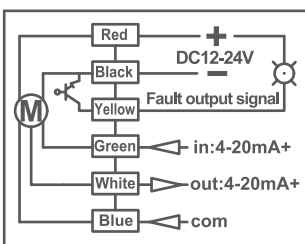

- Red connect +, Black -.
- Green connect input signal +(4-20mA, 0-5V, 0-10V) , Black connect input signal-.
- Yellow connect err output signal.Yellow & Red are disconnected when there is err.
- White connect 4-20mA output .

# Seeking For Global Distributors



**dc DELCO**

Specialized Control Valve Manufacturer



**DELCO VALVE CO.LTD**

**Phone: +86-159 8960 2972**

**Website: [www.delcofluid.com](http://www.delcofluid.com) / [www.delcovalves.com](http://www.delcovalves.com) / [www.delcovalve.ru](http://www.delcovalve.ru)**

**E-mail: [sales@delcofluid.com](mailto:sales@delcofluid.com)**

**Address: Building 8A#, Tiansheng Industrial Park, Wanjiang Street, Dongguan, China**

