

OPTIMAL
SOLUTION
FOR
FURNITURE



MONSOON[®]
Make trust as nature

Monsoon
International(Guangzhou)
Limited

DRAWER SLIDE
Furniture hardware

www.monsoonhardware.com



MONSOON INTERNATIONAL(GUANGZHOU) LIMITED

Monsoon Hardware was established in the year 2011. It's an import and export enterprises with production, research and development, domestic and foreign sales. We have our own factory which area is more than 10000 square meter,with registered capital of 10 million Yuan. Monsoon have many industry-leading plastic processing equipment: Mixers, Granulating machines, PVC sheet extrusion machines, Single extrusion machines, Printing machines, Automatic cutting machines etc, The production capacity is more than 30 million meters per month.

Base in Guandong ,We offer high-quality and environment-friendly product and fast response service for many custom-made furniture brands. Our sales network throughout the country and the sales volume is in the forefront of the industry. Meanwhile our overseas sales grow rapidly, we mostly export to Southeast Asia,Russia,Eastern Europe,Central Asia and other regions. Our products receive the consistent high praise of customers.We firmly believe that Monsoon is your most loyal and trusted cooperation partner on the road to success.In order to reach our quality standard, Monsoon invest much money to set up Strategic cooperative relationship with many famous Chemical brands. We have experienced colorists and a production team to ensure stable quality. The young sales team offer fast response service to our customers.

OUR SUB-BRAND



Maxave is the global furniture hardware company built to transform your furniture hardware business.



Lanttich is a company focused on high-end kitchen hardware applications, bringing customers an unprecedented smart kitchen experience.



Moonplast is an enterprise focusing on environmental edge banding, efficient intelligent production edge banding, and has become an advocate of environmental edge banding.

▶ CONTENT



Powder coating slide



▶ P01-P03



Normal Ball Bearing Slide



▶ P04-P12



Soft closing ball bearing slide



▶ P13-P16



Heavy duty slide



▶ P17-P21



BALL BEARING SLIDE

Ball bearing slide series can realize all kinds of different cabinet solutions whether it is wood, or special plates, monsoon can use different materials and different scenarios, give full play to its product functions, stable and durable.



PRECISION STEEL BALL

MONSOON[®]
Make trust as nature

Double row of precision steel balls, auxiliary push and pull smooth, noise reduction silent



SOFT CLOSING

The buffering effect is not afraid to push, avoid collisions, and reduce noise in your life.

SMOOTH

Double row of balls more balls, Push-pull smooth without holding.



STRONG BEARING CAPACITY

40KG load bearing capacity Super stable, easy to use, More practical.

EASILY DISMOUNTABLE

One-click disassembly Built-in disassembly strip: Easily press and disassemble.



The precisely chosen ball diameters in steel ball slides guarantee smooth movement with excellent repeat positioning accuracy and parallelism.

B TYPE- BOTTOM MOUNTING DRAWER SLIDE

Item NO.: M04201

- Material: Galvanized plate
- Finish: Zinc plated
- Salt spray test:12H
- Loading Capacity:15KG
- Quality grade: EN15338, ANSI/BHMA A156.9,ASTM-B117 test
- Product features: High quality steel ball, Firm and stable, Strong loading capacity.

DRAWING

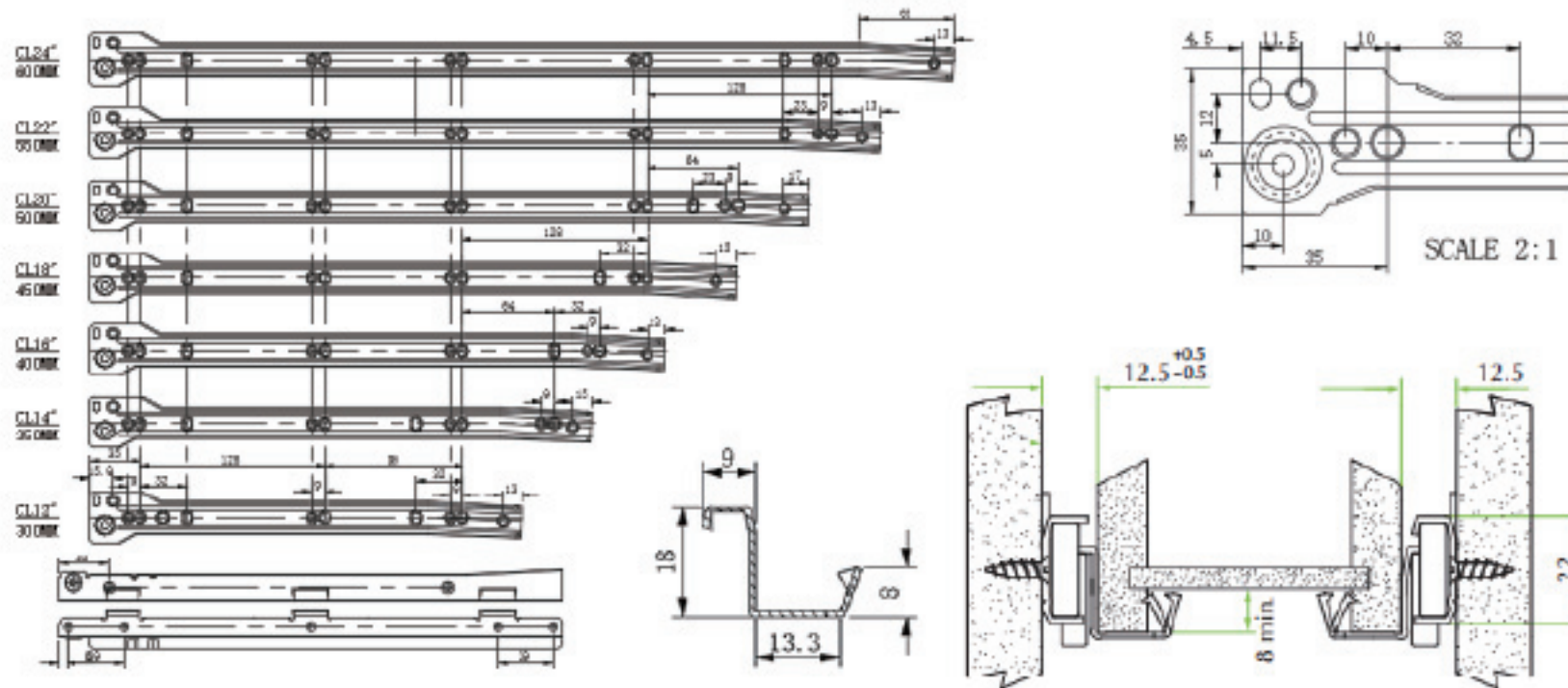

BOTTOM MOUNTING DRAWER SLIDE WITH RUNNER

Item NO.: M04201

- Material: Galvanized plate
- Finish: Zinc plated
- Salt spray test:12H
- Loading Capacity:15KG
- Quality grade: EN15338, ANSI/BHMA A156.9,ASTM-B117 test
- Product features: High quality steel ball, Firm and stable, Strong loading capacity.

DRAWING

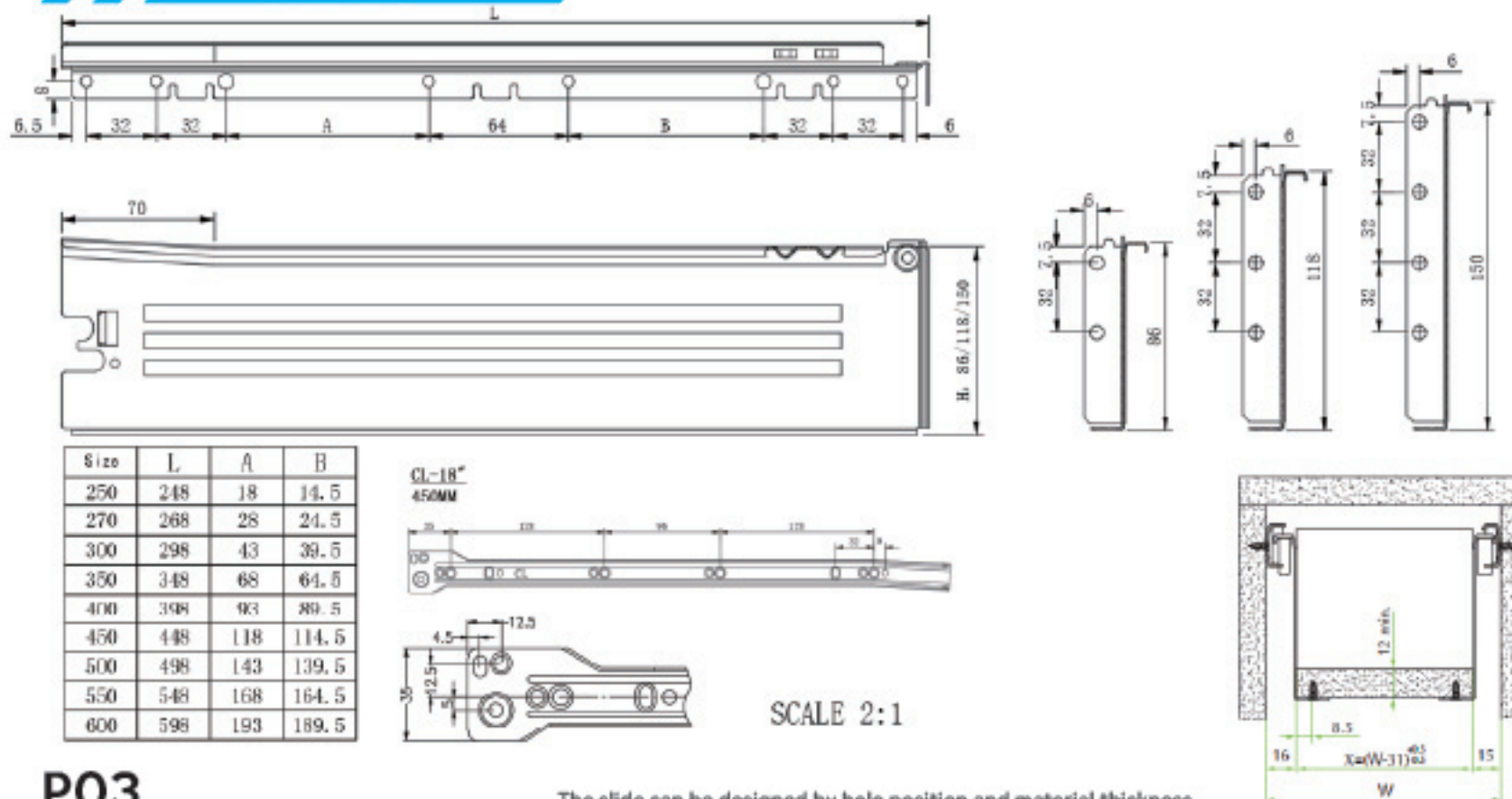

The slide can be designed by hole position and material thickness.



17MM 3/4 EXTENSION SIDE MOUNTING BALL BEARING SLIDE

Item NO.: M03101

- Material: Galvanized plate
- Finish: Zinc plated
- Salt spray test:12H
- Loading Capacity:15KG
- Quality grade: EN15338, ANSI/BHMA A156.9,ASTM-B117 test
- Product features: High quality steel ball, Firm and stable, Strong loading capacity.

DRAWING

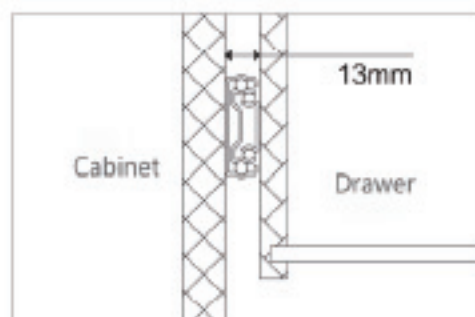
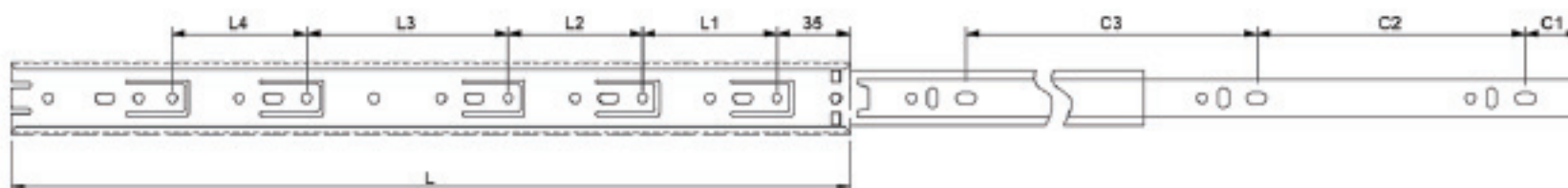

The slide can be designed by hole position and material thickness.

L	L1	L2	L3	L4	C1	C2	C3
250	64	64			32	176	
300	64	64	64		32	96	128
350	64	96	64		32	128	128
400	64	160	64		32	160	160
450	64	192	64		32	160	192
500	64	160	96	64	32	192	224
550	64	160	128	64	32	224	224
600	64	160	160	64	32	256	256



27MM 3/4 EXTENSION SIDE MOUNTING BALL BEARING SLIDE

Item NO.: M03201

- Material: Steel
- Finish: Zinc plated, Black Color
- Salt spray test:12H
- Loading Capacity: 20KG
- Quality grade: EN15338, ANSI/BHMA A156.9, ASTM-B117 test
- Product features: High quality steel ball, Firm and stable, Strong loading capacity.

DRAWING

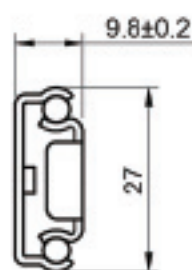
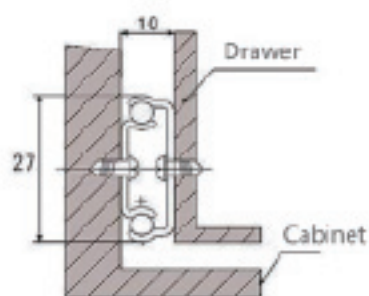
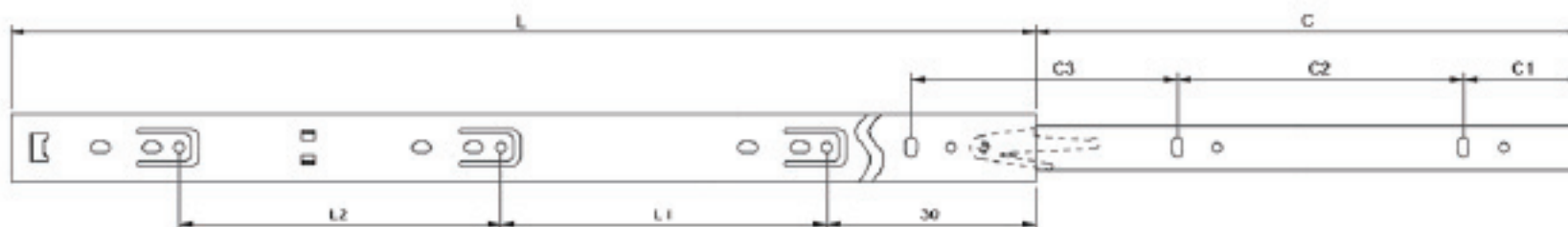

L	L1	L2	C	C1	C2	C3
250	160	96	162	48	96	80
300	96	96	210	48	96	128
350	128	128	236	48	128	128
400	128	160	260	48	160	160
450	192	160	285	48	160	192
500	192	192	310	48	192	224
550	224	224	335	48	224	224

The slide can be designed by hole position and material thickness.



30MM FULL EXTENSION SIDE MOUNTING BALL BEARING SLIDE

Item NO.: M03251

- Material: Steel
- Finish: Zinc plated, Black Color
- Salt spray test:12-24H
- Loading Capacity: 25KG
- Quality grade: EN15338, ANSI/BHMA A156.9, ASTM-B117 test
- Product features: Smooth for open and close, Silent in use, Firm and stable.

DRAWING

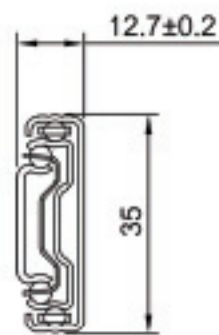
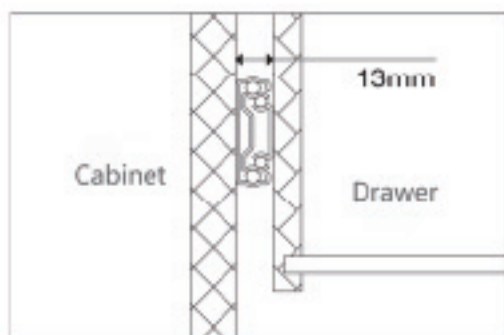
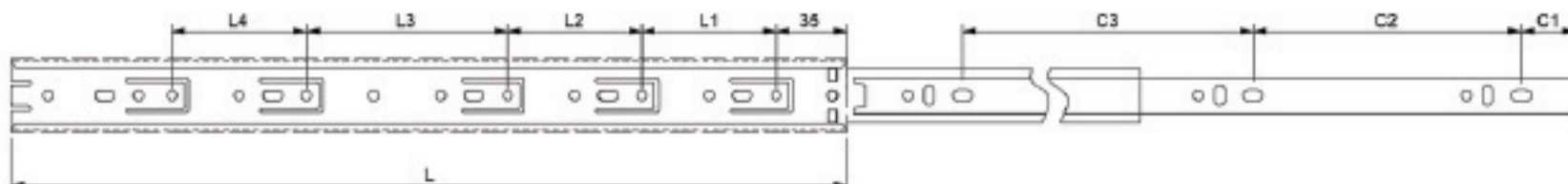

L	L1	L2	L3	L4	C1	C2	C3
250	64	64			32	176	
300	64	64	64		32	96	128
350	64	96	64		32	128	128
400	64	160	64		32	160	160
450	64	192	64		32	160	192
500	64	160	96	64	32	192	224
550	64	160	128	64	32	224	224
600	64	160	160	64	32	256	256

The slide can be designed by hole position and material thickness.



35MM FULL EXTENSION SIDE MOUNTING BALL BEARING SLIDE

Item NO.: M03303

- Material: Steel
- Finish: Zinc plated, Black Color
- Salt spray test:12-24H
- Loading Capacity: 25KG
- Quality grade: EN15338, ANSI/BHMA A156.9, ASTM-B117 test
- Product features: High quality steel ball, Firm and stable, Strong loading capacity.

DRAWING

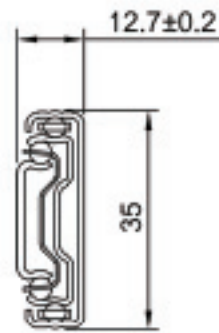
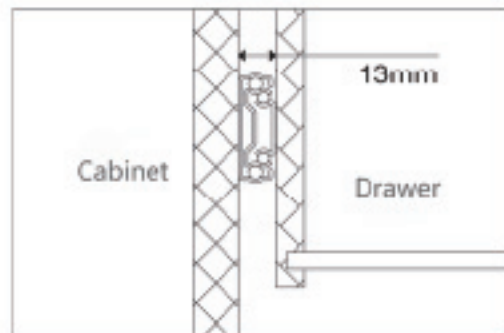
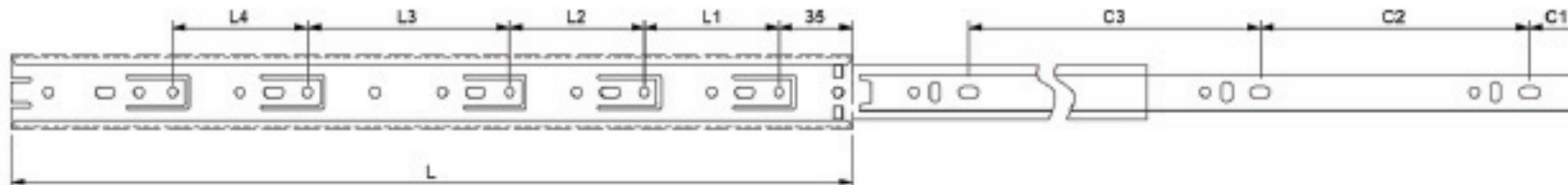

L	L1	L2	L3	L4	C1	C2	C3
250	64	64			32	176	
300	64	64	64		32	96	128
350	64	96	64		32	128	128
400	64	160	64		32	160	160
450	64	192	64		32	160	192
500	64	160	96	64	32	192	224
550	64	160	128	64	32	224	224
600	64	160	160	64	32	256	256

The slide can be designed by hole position and material thickness.



35MM SIDE MOUNTING KEYBOARD BALL BEARING SLIDE

Item NO.: M03304

- Material: Steel
- Finish: Zinc plated, Black Color
- Salt spray test:12-24H
- Loading Capacity: 25KG
- Quality grade: EN15338, ANSI/BHMA A156.9, ASTM-B117 test
- Product features: Smooth for open and close, Silent in use, Firm and stable.

DRAWING

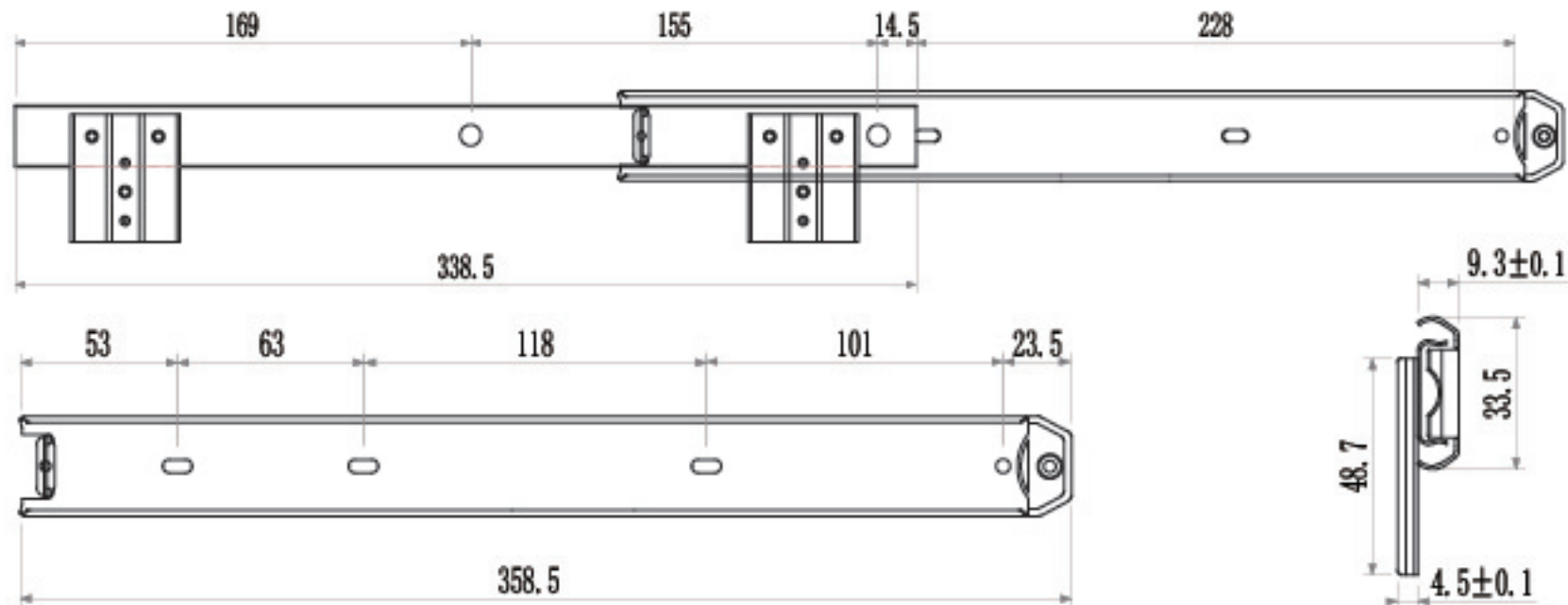

The slide can be designed by hole position and material thickness.



35MM DOUBLE ROW BALL BEARING SLIDE

Item NO.: M03303

- Material: Steel
- Finish: Zinc plated, Black Color
- Salt spray test:12-24H
- Loading Capacity: 25KG
- Quality grade: EN15338, ANSI/BHMA A156.9, ASTM-B117 test
- Product features: High quality steel ball, Firm and stable, Strong loading capacity.

DRAWING

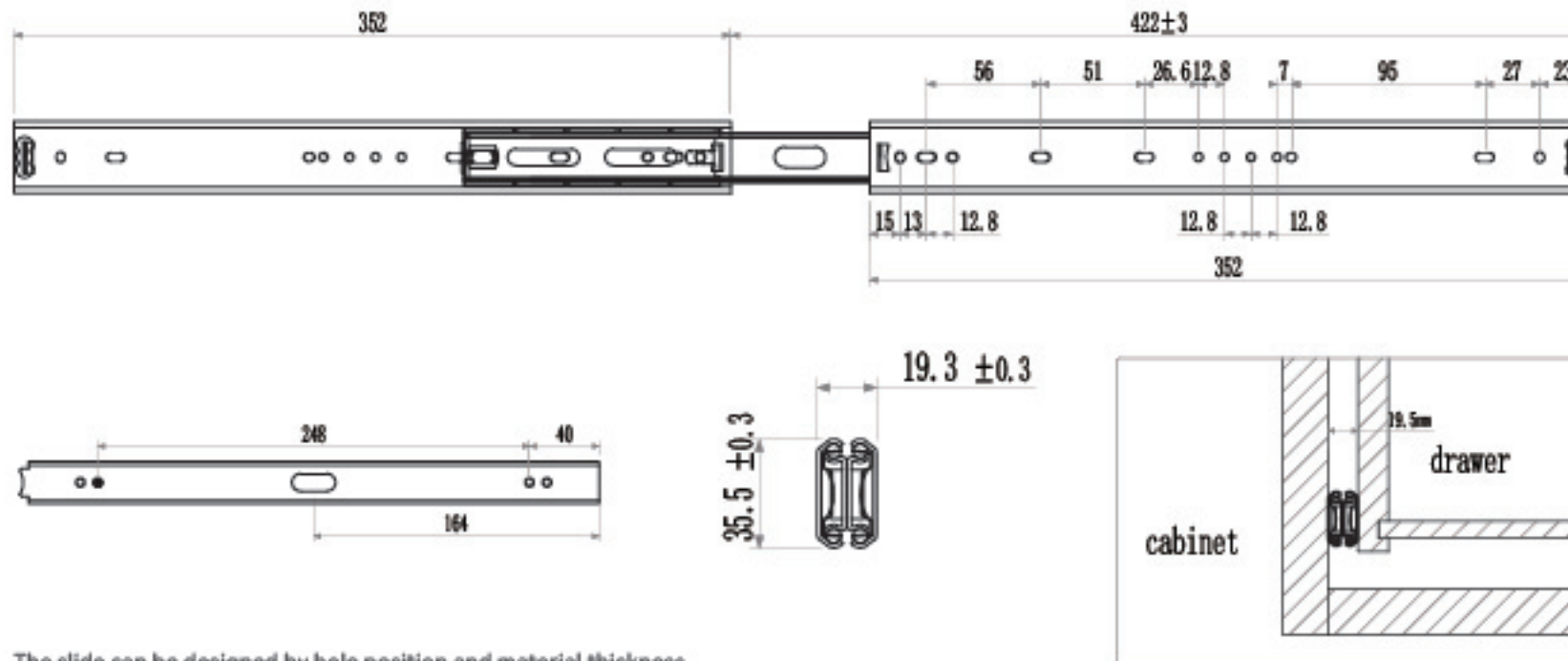

The slide can be designed by hole position and material thickness.



40MM FULL EXTENSION SIDE MOUNTING BALL BEARING SLIDE

Item NO.: M03406

- Material: Steel
- Finish: Zinc plated, Black Color
- Salt spray test:12-24H
- Loading Capacity: 30KG
- Quality grade: EN15338, ANSI/BHMA A156.9, ASTM-B117 test
- Product features: Smooth for open and close, Silent in use, Firm and stable.

DRAWING

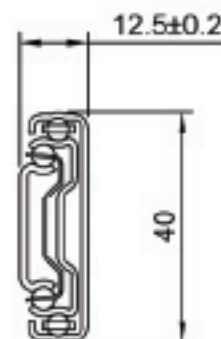
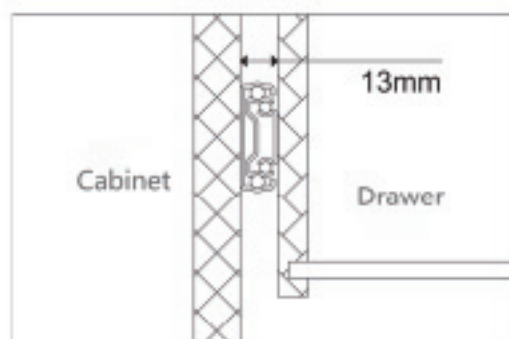
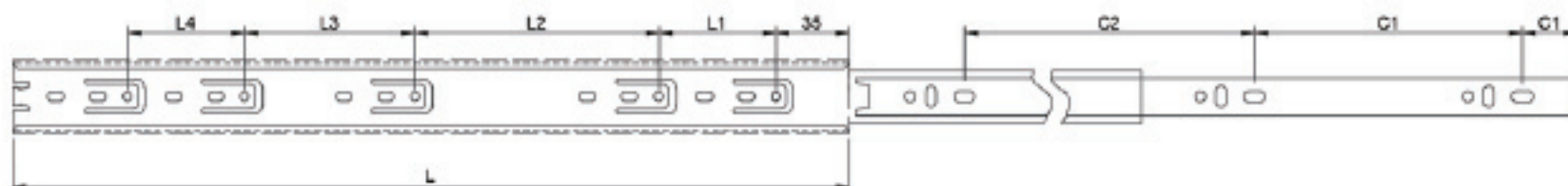

L	L1	L2	L3	L4	C1	C2	C3
250	64	64			32	176	
300	64	64	64		32	98	128
350	64	96	64		32	128	128
400	64	160	64		32	160	160
450	64	192	64		32	160	192
500	64	160	96	64	32	192	224
550	64	160	128	64	32	224	224
600	64	160	160	64	32	256	256

The slide can be designed by hole position and material thickness.



42MM FULL EXTENSION SIDE MOUNTING BALL BEARING SLIDE

Item NO.: M03407

- Material: Steel
- Finish: Zinc plated, Black Color
- Salt spray test:12-24H
- Loading Capacity: 35KG
- Quality grade: EN15338, ANSI/BHMA A156.9, ASTM-B117 test
- Product features: High quality steel ball, Firm and stable, Strong loading capacity.

DRAWING

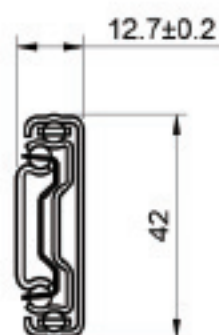
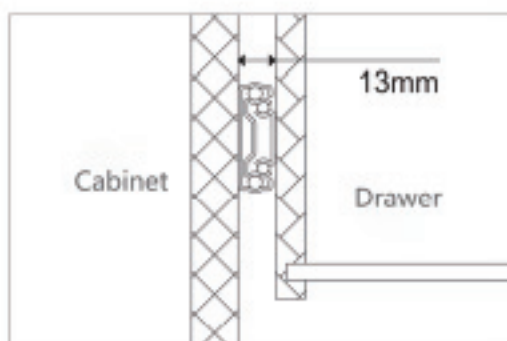
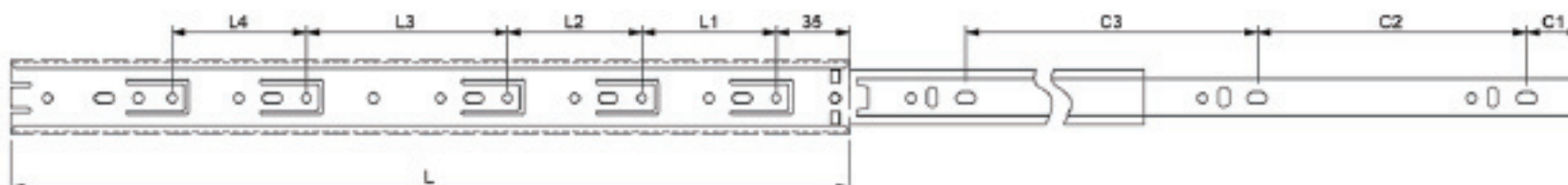

L	L1	L2	L3	L4	C1	C2	C3
250	64	64			32	176	
300	64	64	64		32	96	128
350	64	96	64		32	128	128
400	64	160	64		32	160	160
450	64	192	64		32	160	192
500	64	160	96	64	32	182	224
550	64	160	128	64	32	224	224
600	64	160	160	64	32	256	256

The slide can be designed by hole position and material thickness.



45MM FULL EXTENSION SIDE MOUNTING BALL BEARING SLIDE

Item NO.: M03401

- Material: Steel
- Finish: Zinc plated, Black Color
- Salt spray test:12-24H
- Loading Capacity: 45KG
- Quality grade: EN15338, ANSI/BHMA A156.9, ASTM-B117 test
- Product features: Smooth for open and close, Silent in use, Firm and stable.

DRAWING

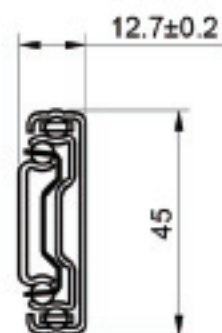
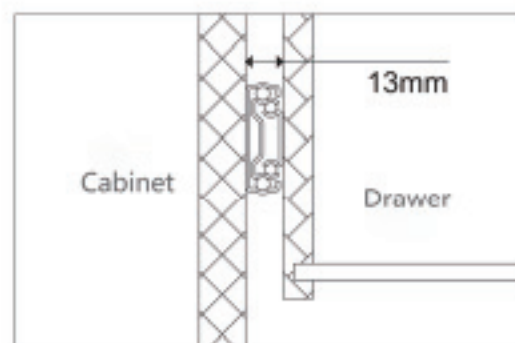
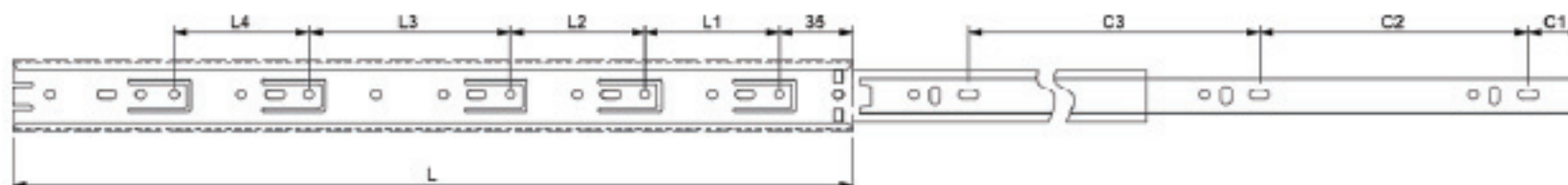

L	L1	L2	L3	L4	C1	C2	C3
250	64	64			32	176	
300	64	64	64		32	96	128
350	64	96	64		32	128	128
400	64	160	64		32	160	160
450	64	192	64		32	160	192
500	64	160	96	64	32	192	224
550	64	160	128	64	32	224	224
600	64	160	160	64	32	256	256

The slide can be designed by hole position and material thickness.

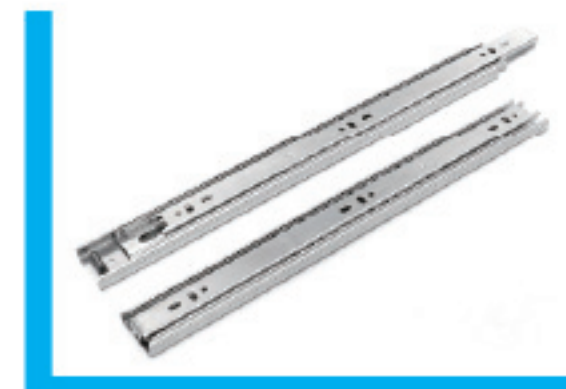

45MM SOFT CLOSING SIDE MOUNTING BALL BEARING SLIDE (SINGLE SPRING)

Item NO.: M03405

- Material: Steel
- Finish: Zinc plated, Black Color
- Salt spray test:12-24H
- Loading Capacity: 35KG
- Quality grade: EN15338, ANSI/BHMA A156.9, ASTM-B117 test
- Product features: High quality steel ball, Firm and stable, Strong loading capacity.

DRAWING

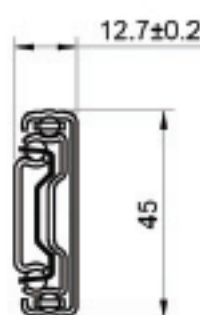
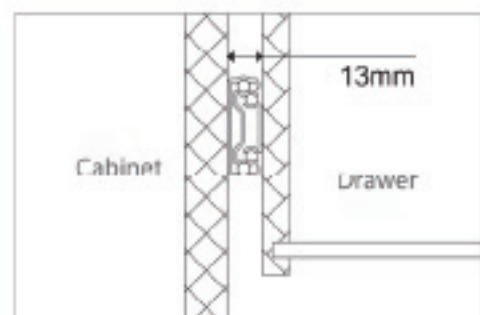
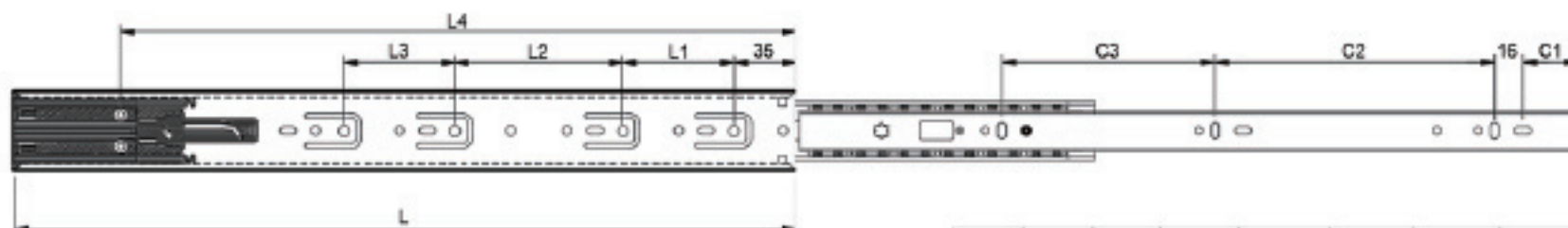

L	L1	L2	L3	L4	C1	C2	C3
250	84			209	32	117	
300	84			259	32	84	103
350	84	96		309	32	96	121
400	84	128		359	32	160	139
450	84	96	64	389	32	160	122
500	84	128	64	439	32	182	140
550	84	192	64	489	32	224	158
600	84	224	64	539	32	224	208

The slide can be designed by hole position and material thickness.



45MM SOFT CLOSING SIDE MOUNTING BALL BEARING SLIDE (DOUBLE SPRING)

Item NO.: M03405

- Material: Steel
- Finish: Zinc plated, Black Color
- Salt spray test:12-24H
- Loading Capacity: 35KG
- Quality grade: EN15338, ANSI/BHMA A156.9, ASTM-B117 test
- Product features: High quality steel ball, Firm and stable, Strong loading capacity.

DRAWING

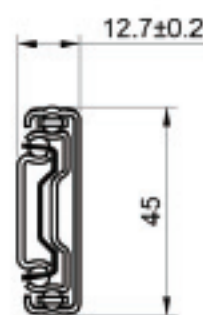
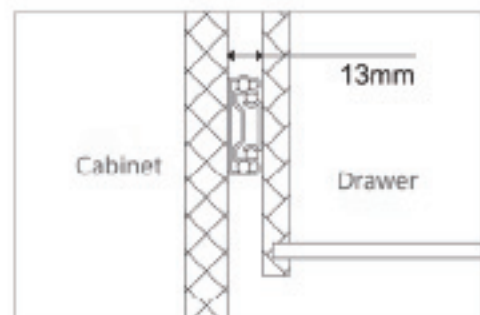
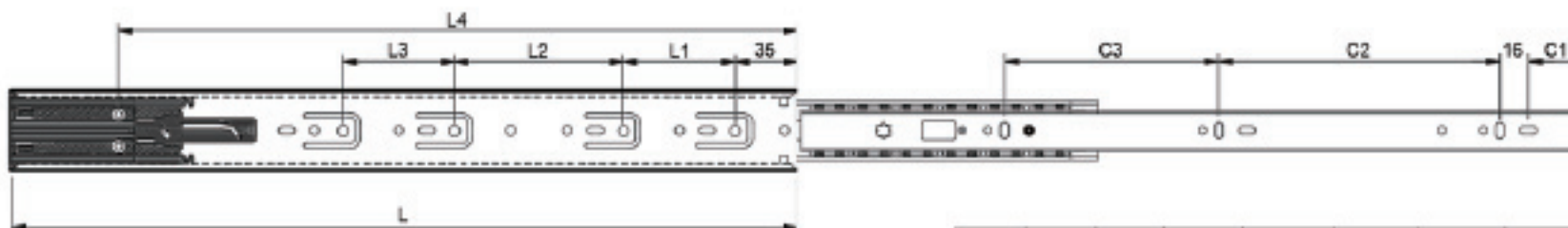

L	L1	L2	L3	L4	C1	C2	C3
250	64			209	32	117	
300	64			259	32	64	103
350	64	96		309	32	96	121
400	64	128		359	32	128	139
450	64	96	64	389	32	160	122
500	64	128	64	439	32	192	140
550	64	160	64	489	32	224	158
600	64	224	64	539	32	224	208

The slide can be designed by hole position and material thickness.



45MM FULL EXTENSION PUSH-TO-OPEN SIDE MOUNTING SLIDE

Item NO.: M03410

- Material: Steel
- Finish: Zinc plated, Black Color
- Salt spray test:12-24H
- Loading Capacity: 35KG
- Quality grade: EN15338, ANSI/BHMA A156.9, ASTM-B117 test
- Product features: Smooth for open and close, Silent in use, Firm and stable.

DRAWING

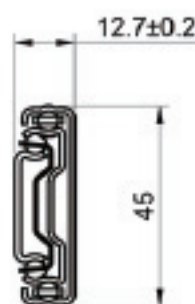
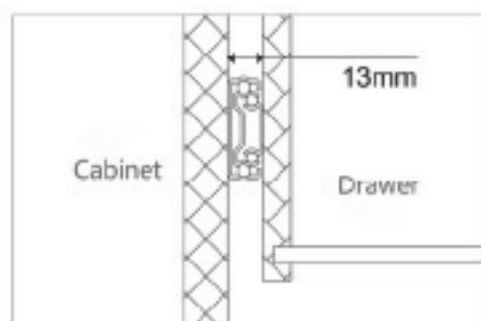
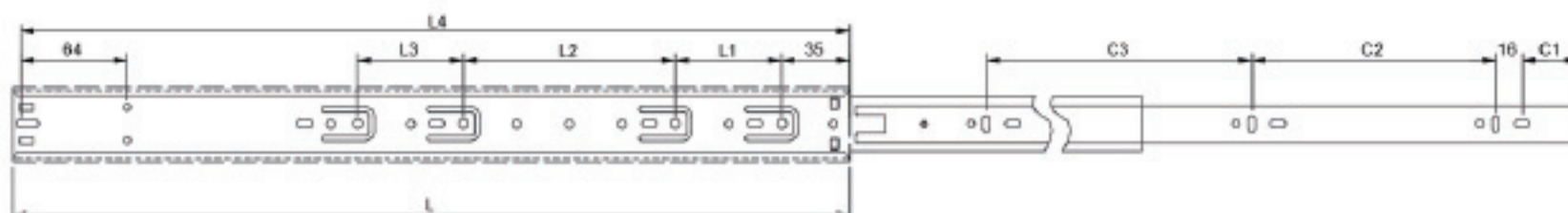

L	L1	L2	L3	L4	C1	C2	C3
250				240	32	135	
300	64			290	32	96	88
350	64	64		340	32	96	128
400	64	128		390	32	128	144
450	64	96	64	440	32	160	160
500	64	128	64	490	32	160	192
550	64	192	64	540	32	192	224
600	64	224	64	590	32	224	224

The slide can be designed by hole position and material thickness.



45MM FULL EXTENSION PUSH-TO-OPEN SOFT CLOSING SIDE MOUNTING SLIDE

Item NO.: M03411

- Material: Steel
- Finish: Zinc plated, Black Color
- Salt spray test:12-24H
- Loading Capacity: 35KG
- Quality grade: EN15338, ANSI/BHMA A156.9, ASTM-B117 test
- Product features: High quality steel ball, Firm and stable, Strong loading capacity.

DRAWING

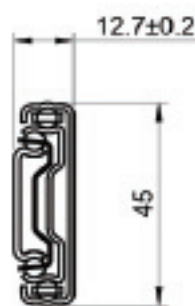
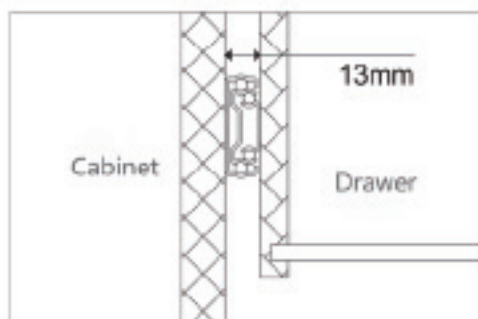
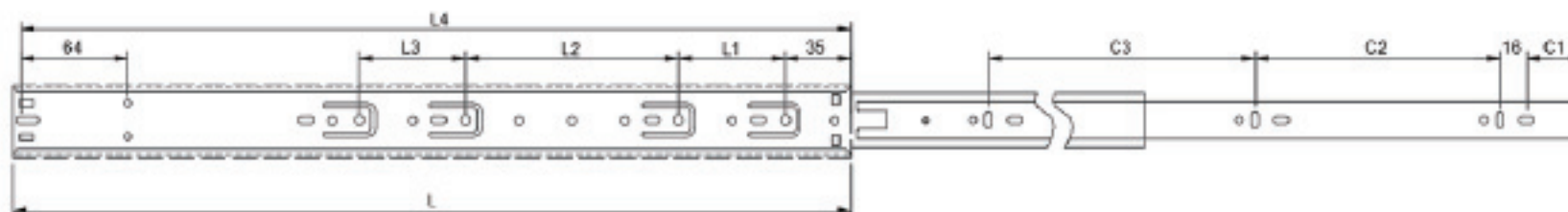

L	L1	L2	L3	L4	C1	C2	C3
250				240	32	135	
300	64			290	32	96	88
350	64	64		340	32	96	128
400	64	128		390	32	128	144
450	64	96	64	440	32	160	160
500	64	128	64	490	32	160	192
550	64	192	64	540	32	192	224
600	64	224	64	590	32	224	224

The slide can be designed by hole position and material thickness.



51MM FULL EXTENSION SIDE MOUNTING HEAVY DUTY SLIDE

Item NO.: M03402

- Material: Steel
- Finish: Zinc plated, Black Color
- Salt spray test:24H
- Loading capacity: 100KG/18"
- Quality grade: EN15338, ANSI/BHMA A156.9, ASTM-B117 test
- Product features: Smooth for open and close, Silent system or push to open available.

DRAWING

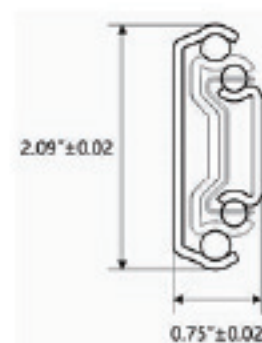
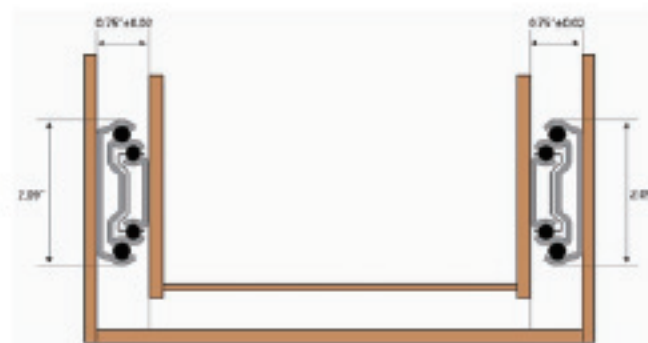
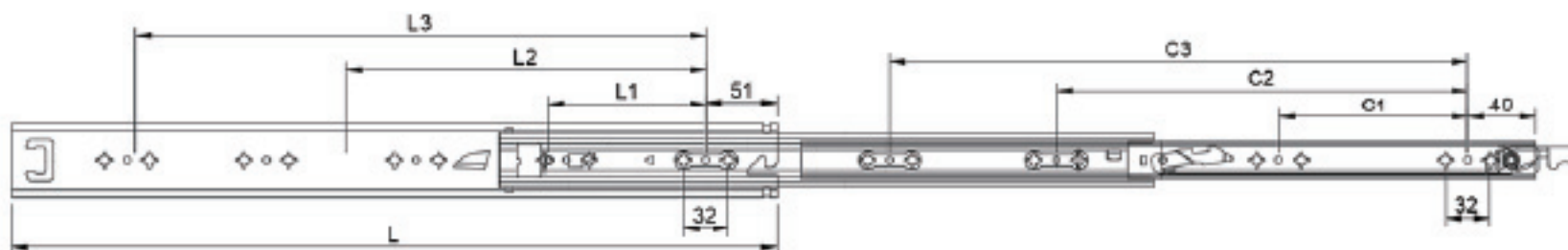

L	L1	L2	L3	C1	C2	C3
350	128	96		96	128	
400	180	128		128	160	
450	192	128		128	192	
500	224	160		160	224	
550	224	100		100	224	
600	256	224		192	288	
650	128	192	192	192	192	128
700	128	224	224	192	192	192
750	180	224	192	192	224	192
800	180	224	224	224	224	224
850	224	224	224	224	256	192
900	256	256	256	256	256	256
950	256	266	266	256	266	266
1000	288	288	288	288	288	288

The slide can be designed by hole position and material thickness.

P17



53MM FULL EXTENSION SIDE MOUNTING HEAVY DUTY SLIDE

Item NO.: M03601

- Material: Steel
- Finish: Zinc plated, Black Color
- Salt spray test:24H
- Loading capacity: 120KG/18"
- Quality grade: EN15338, ANSI/BHMA A156.9, ASTM-B117 test
- Product features: Resistance≤5N, Single pull 12-15N, Smooth for open and close, Silent system.

DRAWING

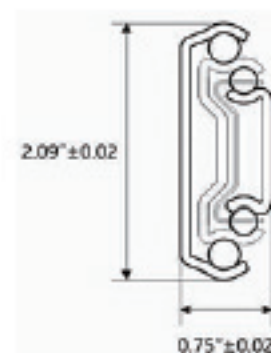
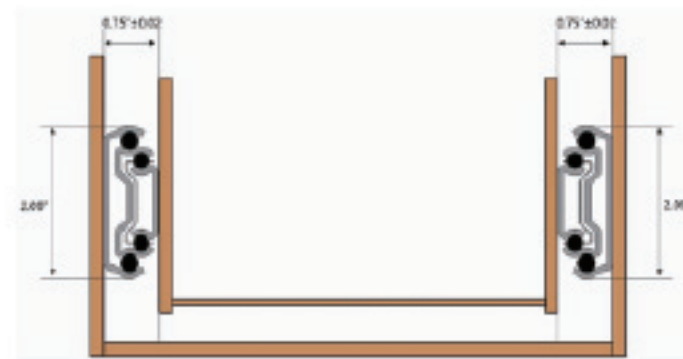
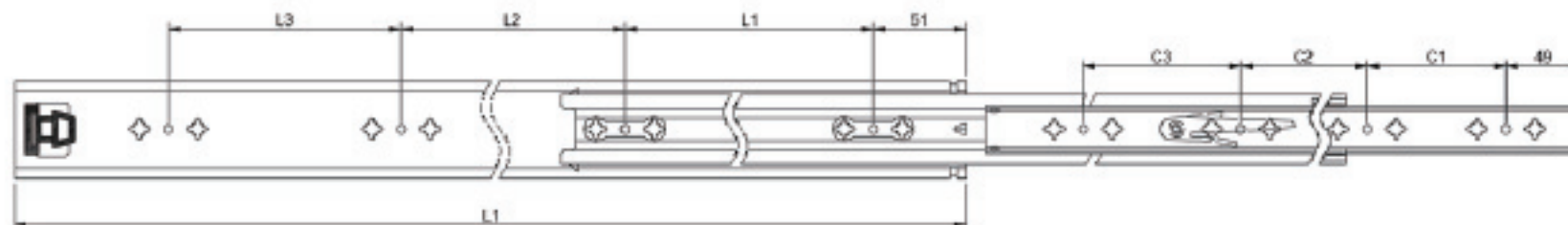

L	L1	L2	L3	C1	C2	C3
360	224			224		
400	128	160		96	192	
450	160	160		128	192	
500	192	192		160	224	
550	192	224		192	224	
600	128	160	192	192	160	128
650	160	160	192	192	192	160
700	192	192	192	192	192	192
750	192	192	192	192	224	192
800	224	224	224	224	224	224
850	224	224	224	224	224	224
900	256	256	256	256	256	256
950	256	288	288	256	288	288
1000	288	288	288	288	288	288

The slide can be designed by hole position and material thickness.



53MM FULL EXTENSION SIDE MOUNTING HEAVY DUTY SLIDE WITH LOCK

Item NO.: L03721

- Material: Steel
- Finish: Zinc plated, Black Color
- Salt spray test:24H
- Loading capacity: 120KG/18"
- Quality grade: EN15338, ANSI/BHMA A156.9, ASTM-B117 test
- Product features: Resistance≤5N, Smooth for open and close, Silent system.

DRAWING

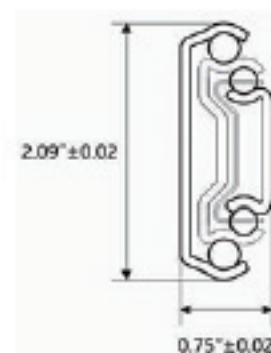
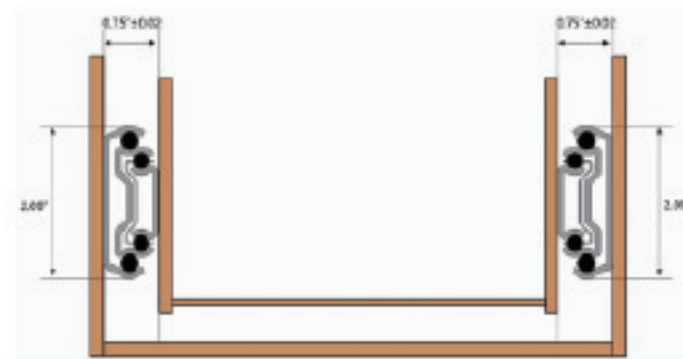
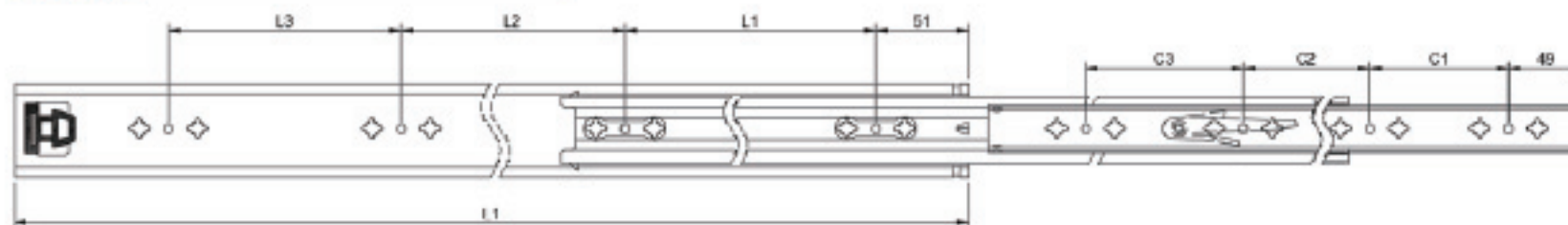

L	L1	L2	L3	C1	C2	C3
380	224			224		
400	128	160		96	192	
450	160	160		128	192	
500	192	192		160	224	
550	192	224		192	224	
600	128	160	192	192	160	128
650	160	160	192	192	192	160
700	192	192	192	192	192	192
750	192	192	192	192	224	192
800	224	224	224	224	224	224
850	224	224	224	224	224	224
900	256	256	256	256	256	256
950	256	288	288	256	288	288
1000	288	288	288	288	288	288

The slide can be designed by hole position and material thickness.

P19



76MM FULL EXTENSION SIDE MOUNTING HEAVY DUTY SLIDE

Item NO.: M03602

- Material: Steel
- Finish: Zinc plated, Black Color
- Salt spray test:24H
- Loading capacity: 220KG/18"
- Quality grade: EN15338, ANSI/BHMA A156.9, ASTM-B117 test
- Product features: Resistance≤5N, Smooth for open and close, Silent system.

DRAWING

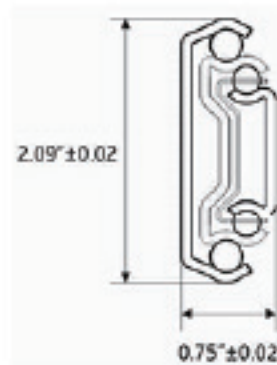
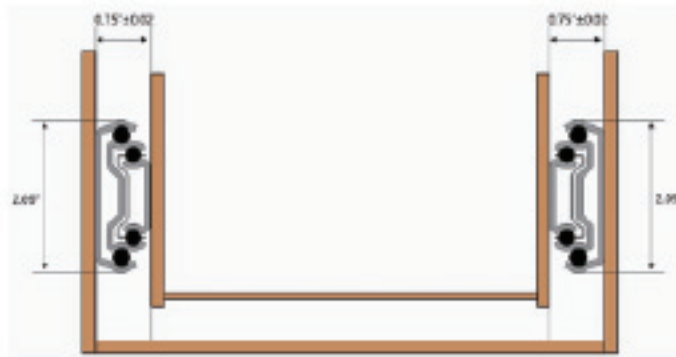
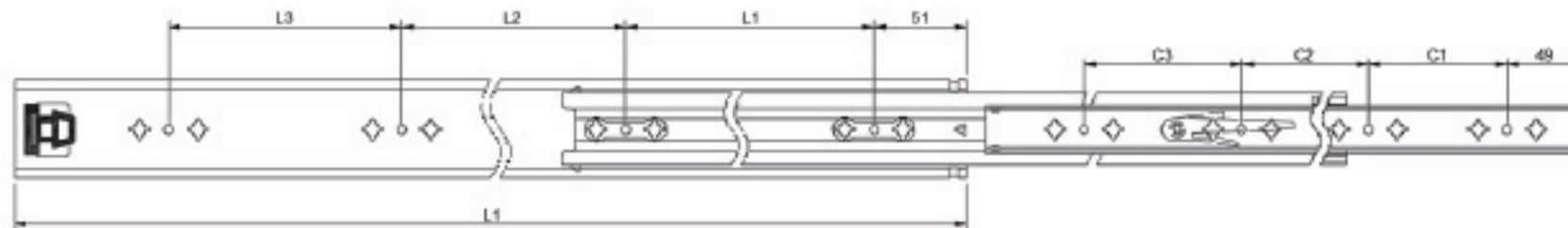

L	L1	L2	L3	C1	C2	C3
350	224			224		
400	128	160		96	192	
450	160	160		128	192	
500	192	192		160	224	
550	192	224		192	224	
600	128	160	192	192	160	128
650	160	160	192	192	192	160
700	192	192	192	192	192	192
750	192	192	192	192	224	192
800	224	224	224	224	224	224
850	224	224	224	224	224	224
900	256	256	256	256	256	256
950	256	288	288	256	288	288
1000	288	288	288	288	288	288

The slide can be designed by hole position and material thickness.

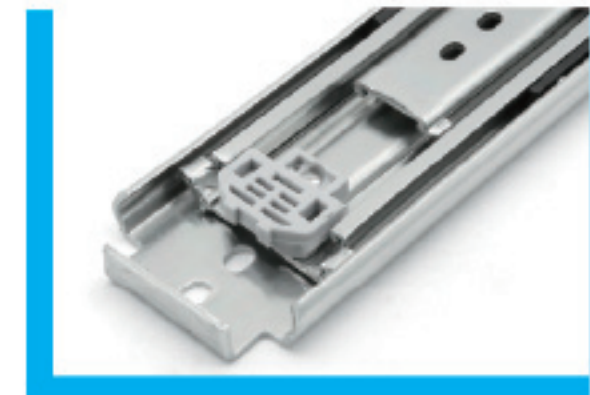

76MM FULL EXTENSION SIDE MOUNTING HEAVY DUTY SLIDE WITH LOCK

Item NO.: L03605

- Material: Steel
- Finish: Zinc plated, Black Color
- Salt spray test:24H
- Loading capacity: 220KG/18"
- Quality grade: EN15338, ANSI/BHMA A156.9, ASTM-B117 test
- Product features: Resistance≤5N, Smooth for open and close, Silent system.

DRAWING

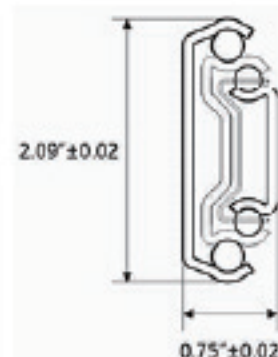
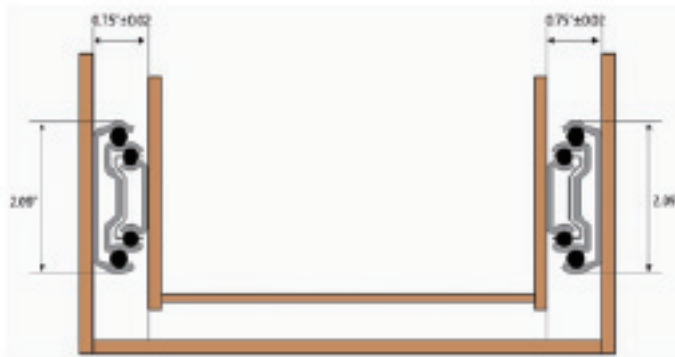
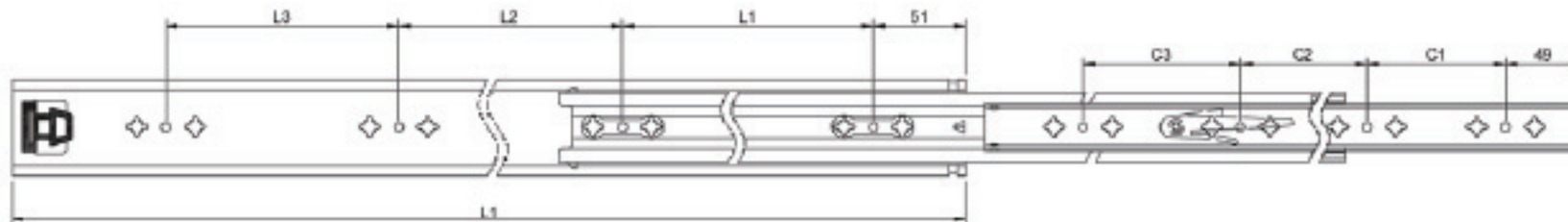

L	L1	L2	L3	C1	C2	C3
350	224			224		
400	128	160		98	192	
450	160	160		128	192	
500	192	192		160	224	
550	192	224		192	224	
600	128	160	192	192	160	128
650	160	160	192	192	192	160
700	192	192	192	192	192	192
750	192	192	192	192	224	192
800	224	224	224	224	224	224
850	224	224	224	224	224	224
900	256	256	258	256	256	258
950	256	288	288	256	288	288
1000	288	288	288	288	288	288

The slide can be designed by hole position and material thickness.

