

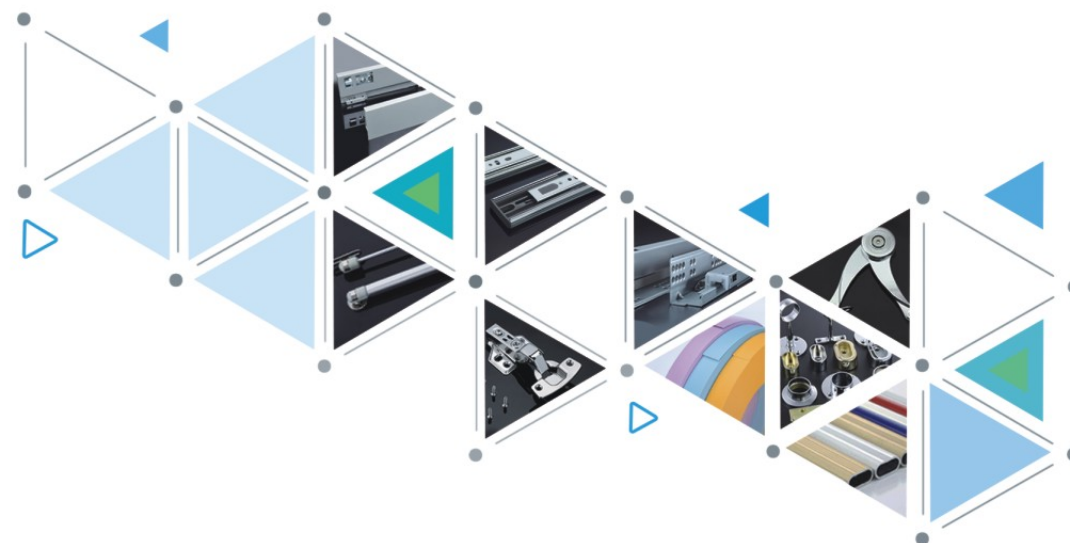

OPTIMAL
SOLUTION
FOR
FURNITURE



MONSOON INTERNATIONAL LIMITED

Tel : 020-39983160

Fax: 020-39983169

Mob: (86)15013034910

Email: 15013034910@mail.ru

sandy@monsoonhardware.com

<http://www.monsoonhardware.com>



BASIC
CATALOG **2018**

MONSOON INTERNATIONAL LIMITED



MONSOON INTERNATIONAL LIMITED
 MONSOON-The optimal solution for furniture hardware accessories.

Monsoon Hardware was established in the year 2011. It's an import and export enterprises with production, research and development, domestic and foreign sales. We mainly produce and develop the PVC edge banding, furniture hinges, ball bearing slides, aluminum profiles and any other furniture accessories product. we have been dedicated to providing cost-effective and high-quality furniture hardware accessories to the furniture manufacturers in the worldwide. The company has been in a state of vigorous development; today Monsoon has been in a leading position in the field of Chinese furniture hardware accessories. Our products are exported to Russia, Europe, South America, North America, South Africa, Southeast Asia, India and other 50 countries and regions in the world. We are awarded as gold supplier by a number of well-known domestic furniture manufacturers many times.

We have been taken the business philosophy for "quality first, customer first, win-win cooperation". While opening up the market, we continuously pay more attention to enhance our group's professionalism and comprehensive competitiveness; and strive to bring the most professional service, the best quality products, the most favorable price, and the most timely after-sales service.

We firmly believe that Monsoon is your most loyal and trusted cooperation partner on the road to success.



MONSOON	Specification List		
	Item	Range	Tolerance Range
Width		12~20mm	-0.2; +0.5mm
		21~54mm	-0.2; +0.8mm
Thickness		0.4~0.7mm	±0.05mm
		0.8~1.5mm	±0.1mm
		1.6~2.0mm	±0.15mm
		2.1~3.0mm	±0.2mm
Surface gloss		5~30°	±0.3°
		31~90°	±0.5°
Meters/Roll		≤100m	±0.5m
		100~300m	±0.8m

Note : The size details and tolerance range of profile series can be negotiated by both parties.



Description

PVC/ABS edge banding woodgrain color

We're professional manufacturer of high quality PVC edge banding in China. Our woodgrain color series PVC edge banding uses high quality new material, scientific formula, unique process. The woodgrain color is colored and printed with all kind of woodgrain pattern, the finished products have high simulated woodgrain effect, natural effect. It has flat, smooth and glabrous surface, good decorative protective properties, strong adhesion. Regular thickness is 0.4mm-3mm, width can be 15-90mm. For 0.4-0.6mm thickness, it can be cut to any width according to customer's demand conveniently, for thickness 0.8-3mm, the width is extruded directly. Edge banding can match with board perfectly. Stable quality is ensured, deformation resistance, angeresistance, color keep the same after trimming, color of thin and thick one can keep the same. We can customize any of your colors and embossing.

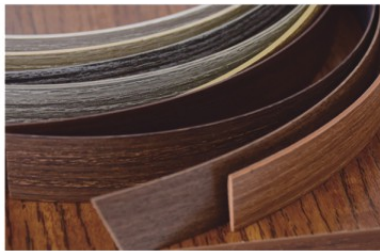

Description

PVC/ABS edge banding high-glossy color

We're professional manufacturer of high quality PVC edge banding in China. The high-glossy color series PVC edge banding uses high quality new material, high quality UV and ink, scientific formula, unique process. It has high-glossy solid color and high-glossy woodgrain color. The finished products surface reflects a mirror effect, rich in color, and high gloss effect, the glossiness is over 70%. It has flat, smooth and glabrous surface, good decorative protective properties, strong adhesion. Regular thickness is 0.4mm-3mm, width can be 15-90mm. For 0.4-0.6mm thickness, it can be cut to any width according to customer's demand conveniently, for thickness 0.8-3mm, the width is extruded directly. Edge banding can match with board perfectly. Stable quality is ensured, deformation resistance, angeresistance, color keep the same after trimming, color of thin and thick one can keep the same. We can customize any of your colors and embossing.



Description

PVC/ABS edge banding solid color

We're professional manufacturer of high quality PVC edge banding in China. Our solid color PVC edge banding uses high quality new material, scientific formula, unique process. The solid color series has rich and bright colors for choice. It has flat, smooth and glabrous surface, good decorative protective properties, strong adhesion. Regular thickness is 0.4mm-3mm, width can be 15-90mm. For 0.4-0.6mm thickness, it can be cut to any width according to customer's demand conveniently, for thickness 0.8-3mm, the width is extruded directly. Edge banding can match with board perfectly. Stable quality is ensured, deformation resistance, angeresistance, color keep the same after trimming, color of thin and thick one can keep the same. We can customize any of your colors and embossing.

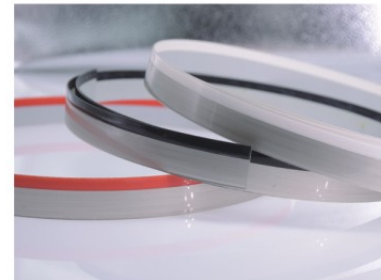

Description

3D acrylic edge banding

We're professional manufacturer of high quality PVC edge banding in China. Acrylic edge banding is made and precise processed of acrylic resin, its features are high transparency, weather resistance, impact resistance and abrasion resistance. This product has an elegant appearance, strong 3 dimensional effect, it is commonly used for classy panel furniture with 3D pattern edge banding. It can do single color and double color. There are many color combinations. This series has brilliant and fashionable color. And the strong stereoscopic impression make it become the best choice of high end cupboard. It has flat, smooth and glabrous surface, good decorative protective properties, strong adhesion. Regular thickness is 1mm-2mm, width can be 19-30mm. Edge banding can match with board perfectly. Stable quality is ensured, deformation resistance, angeresistance, color keep the same after trimming. We can customize any of your colors.



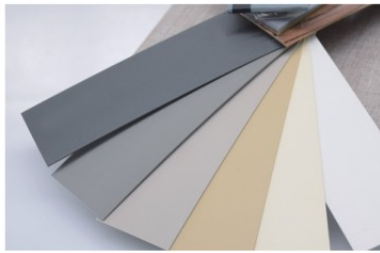

Description

PVC/ABS edge banding matt color

We're professional manufacturer of high quality PVC edge banding in China. We use high quality new material, scientific formula, unique process. For matt color edge banding, the color tone is soft and the surface is rougher than the high gloss. There is no flashing, no glare in lighting, with the diffuse reflection, it can keep eye from light pollution. This series apply to bedroom, study room and etc, where people prefer to the place with soft light. It has flat, smooth and glabrous surface, good decorative protective properties, strong adhesion. Regular thickness is 0.4mm-3mm, width can be 15-90mm. For 0.4-0.6mm thickness, it can be cut to any width according to customer's demand conveniently, for thickness 0.8-3mm, the width is extruded directly. Edge banding can match with board perfectly. Stable quality is ensured, deformation resistance, angeresistance, color keep the same after trimming, color of thin and thick one can keep the same. We can customize any of your colors.

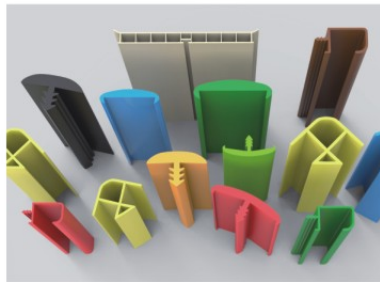
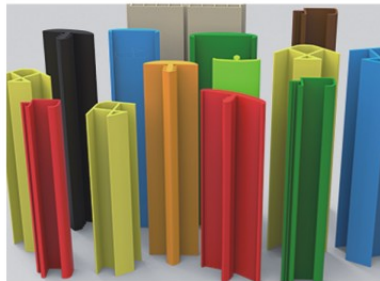

Description

PVC profile edge banding

Profile series have soft strips, hard strips, and soft and hard composite strips. Soft strip with a soft, sealing, impact resistance features; rigid strip has variety of shapes, high strength, is a furniture hardware accessories alternatives; hard composite tape developed by both parties. It has T type, U type, and some other not regular models, colorful. The profile series is made by good quality PVC material and precise tooling, it is easy to be sealed and has long usage period, which make it become the good choice for office furniture.

热熔胶/HOT MELT GLUE

低温热熔胶
Low temperature
hot melt glue
01901

中温热熔胶
Medium temperature
hot melt glue
01902

高温热熔胶
High temperature
hot melt glue
01903



棕色胶/brown glue



黑色胶/Black glue



加白胶/white glue



乳白胶/milk-white glue

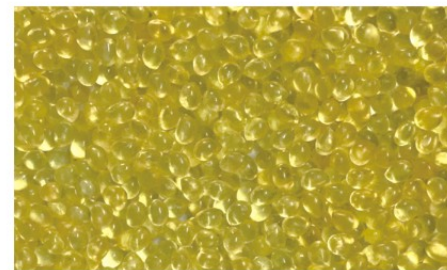

透明胶/transparent glue



透明胶/transparent glue

Exquisite craft Precision equipment

Excellent quality and durable material achievements of the perfect product



产品描述/Description

26 一段式开口铰链/φ26 One way slide on hinge

开启角度: 95度
铰杯高度: 11.3毫米
铰杯直径: 26毫米
门可选用板厚度: 12-22毫米

Open degree: 95°
Height of hinge cup: 11.3mm
Diameter of hinge cup: 26mm
Range of doors thickness: 12-22mm

直臂
FULL
OVERLAY



中弯
HALF
OVERLAY



大弯
INSERTED



02105

H:底座高度 D:侧板上所需盖位 K:门板外线与铰杯钻孔距离 A:门与侧板间隙

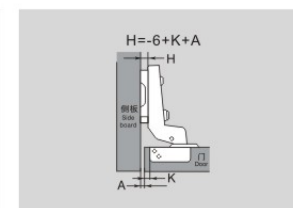
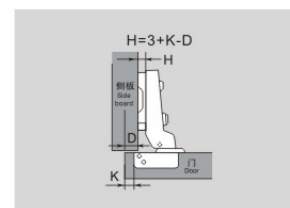
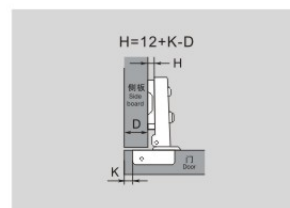

D:盖位计算值 Overlay calculations

D	H	K	3	4	5
0	15	16	17		
2	13	14	15		
4	12	12	13		

D:盖位计算值 Overlay calculations

D	H	K	3	4	5
0	13	14	15		
2	11	12	13		
4	9	10	11		

D:盖位计算值 Overlay calculations

D	H	K	3	4	5
0	3	2	1		
2	1	2	3		
4	7	6	5		



铰链安装钻孔尺寸 (Hinge cup types)

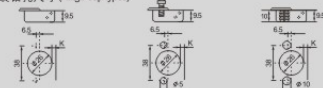

可选择底片
Choose Plate





产品描述/Description

26 快装阻尼铰链/ $\phi 26$ Clip on soft closing hinge

开启角度: 95度
铰杯高度: 11.3毫米
铰杯直径: 26毫米
门可选用板厚度: 12-22毫米

Open degree: 95°
Height of hinge cup: 11.3mm
Diameter of hinge cup: 26mm
Range of doors thickness: 12-22mm



产品描述/Description

26 固装阻尼铰链/ $\phi 26$ Fixed soft closing hinge

开启角度: 95度
铰杯高度: 11.3毫米
铰杯直径: 26毫米
门可选用板厚度: 12-22毫米

Open degree: 95°
Height of hinge cup: 11.3mm
Diameter of hinge cup: 26mm
Range of doors thickness: 12-22mm

直臂
FULL
OVERLAY



中弯
HALF
OVERLAY



大弯
INSERTED



02203

H:底座高度 D:侧板上所需盖位 K:门板外线与铰杯钻孔距离 A:门与侧板间隙

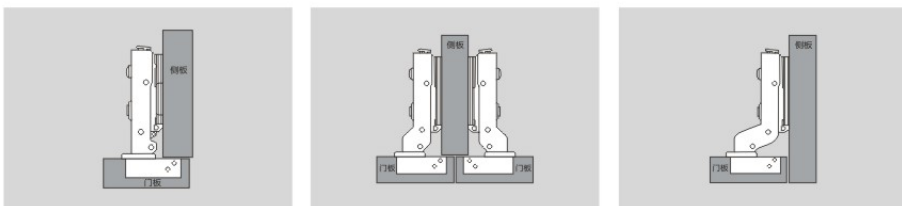

D:盖位计算值表 Overlay calculations

D	H	K	3	4	5	6	7
H=0			16	17	18	19	20
H=3			13	14	15	16	17
H=5			11	12	13	14	15

D:盖位计算值表 Overlay calculations

D	H	K	3	4	5	6	7
H=0			7	8	9	10	11
H=3			4	5	6	7	8
H=5			2	3	4	5	6

D:盖位计算值表 Overlay calculations

D	H	K	3	4	5	6	7
H=0			-2.5	-1.5	-0.5	0.5	1.5

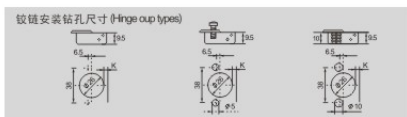

可选择底片
Choose Plate



直臂
FULL
OVERLAY



中弯
HALF
OVERLAY



大弯
INSERTED



02504

H:底座高度 D:侧板上所需盖位 K:门板外线与铰杯钻孔距离 A:门与侧板间隙

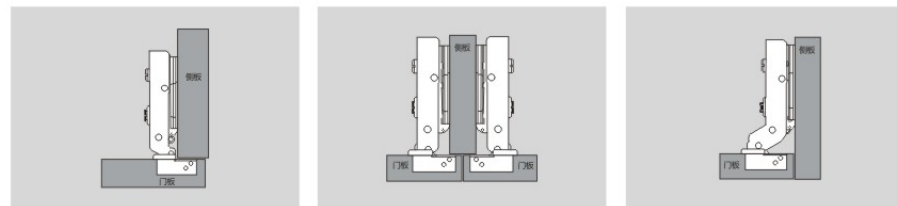

D:盖位计算值表 Overlay calculations

D	H	K	3	4	5	6	7
H=0			14	15	16	17	18
H=3			11	12	13	14	15
H=5			9	10	11	12	13

D:盖位计算值表 Overlay calculations

D	H	K	3	4	5	6	7
H=0			5.5	6.5	7.5	8.5	9.5
H=3			2.5	3.5	4.5	5.5	6.5
H=5			0.5	1.5	2.5	3.5	4.5

D:盖位计算值表 Overlay calculations

D	H	K	3	4	5	6	7
H=0			-2.5	-1.5	-0.5	0.5	1.5

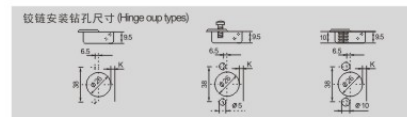

可选择底片
Choose Plate





产品描述/Description

35 一段力开口铰链/ ϕ 35 One way slide on hinge

开启角度: 105度
铰杯高度: 11.3毫米
铰杯直径: 35毫米
门可选用板厚度: 14-24毫米

Open degree: 105°
Height of hinge cup: 11.3mm
Diameter of hinge cup: 35mm
Range of doors thickness: 14-24mm



产品描述/Description

35 二段力开口铰链/ ϕ 35 Two way slide on hinge

开启角度: 105度
铰杯高度: 11.3毫米
铰杯直径: 35毫米
门可选用板厚度: 14-24毫米

Open degree: 105°
Height of hinge cup: 11.3mm
Diameter of hinge cup: 35mm
Range of doors thickness: 14-24mm



02141

H:底座高度 D:侧板上所需盖位 K:门板外线与铰杯钻孔距离 A:门与侧板间隙

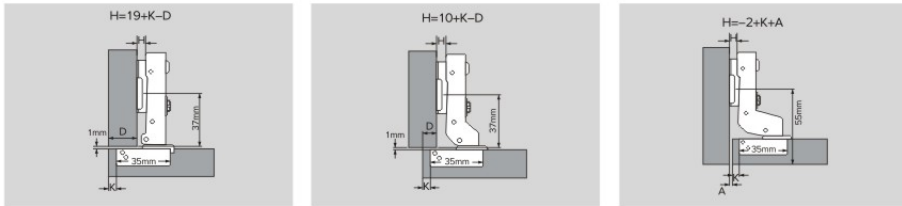

D:盖位计算值表 Overlay calculations

D	H	K	3	4	5	6	7
-2	18	19	20	21	22		
1	16	17	18	19	20		
2	14	15	16	17	18		
4	12	13	14	15	16		

D:盖位计算值表 Overlay calculations

D	H	K	3	4	5	6	7
-2	10	11	12	13	14		
0	8	9	10	11	12		
2	6	7	8	9	10		
4	4	5	6	7	8		

D:盖位计算值表 Overlay calculations

D	H	K	3	4	5	6	7
0	-1	-2	-3	-4	-5		
2	1	0	-1	-2	-3		
4	3	2	1	0	-1		

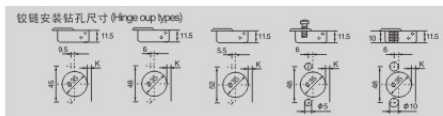

可选择底片
Choose Plate



02121

H:底座高度 D:侧板上所需盖位 K:门板外线与铰杯钻孔距离 A:门与侧板间隙

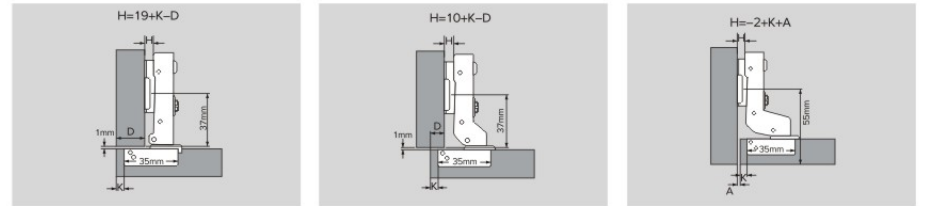

D:盖位计算值表 Overlay calculations

D	H	K	3	4	5	6	7
-2	18	19	20	21	22		
1	16	17	18	19	20		
2	14	15	16	17	18		
4	12	13	14	15	16		

D:盖位计算值表 Overlay calculations

D	H	K	3	4	5	6	7
-2	10	11	12	13	14		
0	8	9	10	11	12		
2	6	7	8	9	10		
4	4	5	6	7	8		

D:盖位计算值表 Overlay calculations

D	H	K	3	4	5	6	7
0	-1	-2	-3	-4	-5		
2	1	0	-1	-2	-3		
4	3	2	1	0	-1		

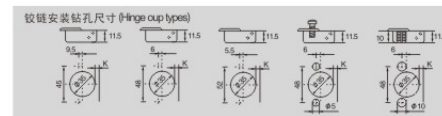

可选择底片
Choose Plate





产品描述/Description

35 一段力快装阻尼铰链
φ35 One way clip on soft closing hinge

开启角度: 105度
铰杯高度: 11.3毫米
铰杯直径: 35毫米
门可选用板厚度: 14-24毫米

Open degree: 105°
Height of hinge cup: 11.3mm
Diameter of hinge cup: 35mm
Range of doors thickness: 14-24mm



产品描述/Description

35 快装阻尼铰链/ φ35 Clip on soft closing hinge

开启角度: 105度
铰杯高度: 11.3毫米
铰杯直径: 35毫米
门可选用板厚度: 14-24毫米

Open degree: 105°
Height of hinge cup: 11.3mm
Diameter of hinge cup: 35mm
Range of doors thickness: 14-24mm

直臂
FULL
OVERLAY



中弯
HALF
OVERLAY



大弯
INSERTED



直臂
FULL
OVERLAY



中弯
HALF
OVERLAY



大弯
INSERTED



02340

H:底座高度 D:侧板上所需盖位 K:门板外线与铰杯钻孔距离 A:门与侧板间隙

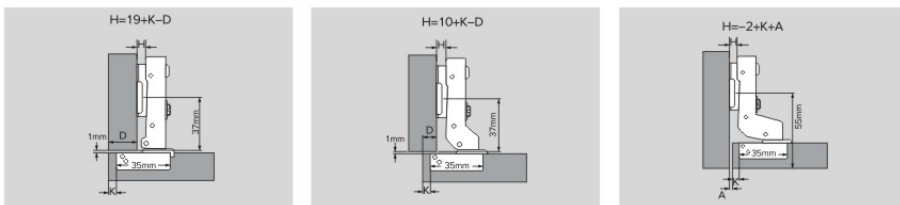

D:盖位计算值表 Overlay calculations

D	H	K	3	4	5	6	7
-2	18	19	20	21	22		
1	16	17	18	19	20		
2	14	15	16	17	18		
4	12	13	14	15	16		

D:盖位计算值表 Overlay calculations

D	H	K	3	4	5	6	7
-2	10	11	12	13	14		
0	8	9	10	11	12		
2	6	7	8	9	10		
4	4	5	6	7	8		

D:盖位计算值表 Overlay calculations

D	H	K	3	4	5	6	7
0	-1	-2	-3	-4	-5		
2	1	0	-1	-2	-3		
4	3	2	1	0	-1		

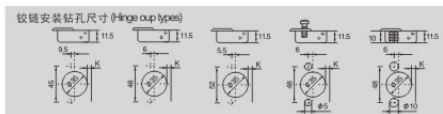

可选择底片
Choose Plate



02341

H:底座高度 D:侧板上所需盖位 K:门板外线与铰杯钻孔距离 A:门与侧板间隙

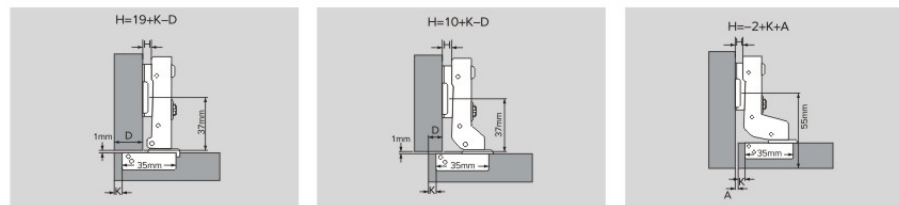

D:盖位计算值表 Overlay calculations

D	H	K	3	4	5	6	7
-2	18	19	20	21	22		
1	16	17	18	19	20		
2	14	15	16	17	18		
4	12	13	14	15	16		

D:盖位计算值表 Overlay calculations

D	H	K	3	4	5	6	7
-2	10	11	12	13	14		
0	8	9	10	11	12		
2	6	7	8	9	10		
4	4	5	6	7	8		

D:盖位计算值表 Overlay calculations

D	H	K	3	4	5	6	7
0	-1	-2	-3	-4	-5		
2	1	0	-1	-2	-3		
4	3	2	1	0	-1		

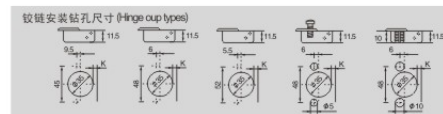



产品描述/Description

35 一段力固装阻尼铝框铰链
φ35 One way fixed type hydraulic aluminum frame hinge

开启角度: 105度 Open degree: 105°
铰杯高度: 11.3毫米 Height of hinge cup: 11.3mm
铰杯直径: 35毫米 Diameter of hinge cup: 35mm
门可选用板厚度: 14-24毫米 Range of doors thickness: 14-24mm



产品描述/Description

35 一段力固装阻尼铰链
φ35 One way fixed type hydraulic hinge

开启角度: 105度 Open degree: 105°
铰杯高度: 11.3毫米 Height of hinge cup: 11.3mm
铰杯直径: 35毫米 Diameter of hinge cup: 35mm
门可选用板厚度: 14-24毫米 Range of doors thickness: 14-24mm

直臂
FULL
OVERLAY



中弯
HALF
OVERLAY



大弯
INSERTED



02681

H:底座高度 D:侧板上所需盖位 K:门板外线与铰杯钻孔距离 A:门与侧板间隙

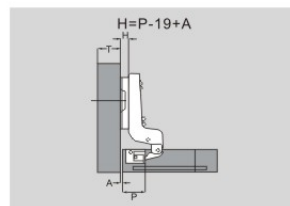
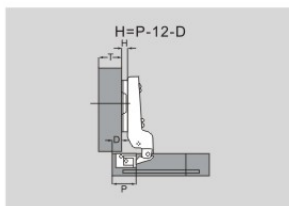
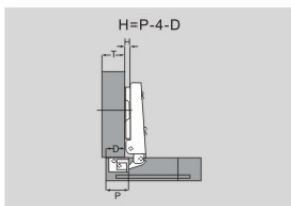

D:盖位计算值表 Overlay calculations

D	H	K	19	20	21	22	23	24
0	15	16	17	18	19	20		
2	13	14	15	16	17	18		
4	11	12	13	14	15	16		

D:盖位计算值表 Overlay calculations

D	H	K	19	20	21	22	23	24
0	7	8	9	10	11	12		
2	5	6	7	8	9	10		
4	3	4	5	6	7	8		

D:盖位计算值表 Overlay calculations

D	H	K	19	20	21	22	23	24
0	0	-1	-2	-3	-4	-5		
2	2	1	0	-1	-2	-3		
4	4	3	2	1	0	-1		

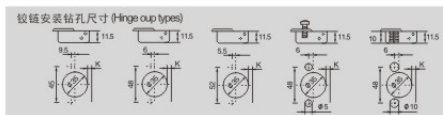

直臂
FULL
OVERLAY



中弯
HALF
OVERLAY



大弯
INSERTED



02526

H:底座高度 D:侧板上所需盖位 K:门板外线与铰杯钻孔距离 A:门与侧板间隙

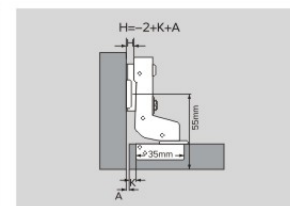
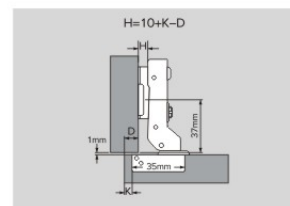
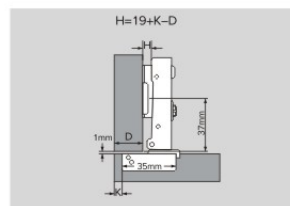

D:盖位计算值表 Overlay calculations

D	H	K	3	4	5	6	7
-2	18	19	20	21	22		
1	16	17	18	19	20		
2	14	15	16	17	18		
4	12	13	14	15	16		

D:盖位计算值表 Overlay calculations

D	H	K	3	4	5	6	7
-2	10	11	12	13	14		
0	8	9	10	11	12		
2	6	7	8	9	10		
4	4	5	6	7	8		

D:盖位计算值表 Overlay calculations

D	H	K	3	4	5	6	7
0	-1	-2	-3	-4	-5		
2	1	0	-1	-2	-3		
4	3	2	1	0	-1		

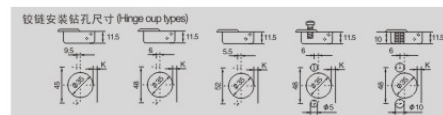



产品描述/Description

35 一段力快装阻尼铰链
φ35 One way clip on soft closing hinge

开启角度: 105度 Open degree: 105°
铰杯高度: 11.3毫米 Height of hinge cup: 11.3mm
铰杯直径: 35毫米 Diameter of hinge cup: 35mm
门可选用板厚度: 14-24毫米 Range of doors thickness: 14-24mm



产品描述/Description

35 开尾固定装阻尼铰链
φ35 Cotter fixed type hydraulic hinge

开启角度: 105度 Open degree: 105°
铰杯高度: 11.3毫米 Height of hinge cup: 11.3mm
铰杯直径: 35毫米 Diameter of hinge cup: 35mm
门可选用板厚度: 14-24毫米 Range of doors thickness: 14-24mm

直臂
FULL
OVERLAY



中弯
HALF
OVERLAY



大弯
INSERTED



02343

H:底座高度 D:侧板上所需盖位 K:门板外线与铰杯钻孔距离 A:门与侧板间隙

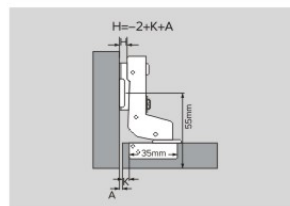
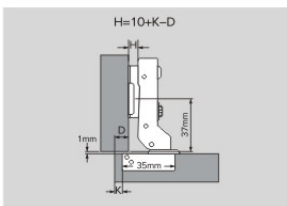
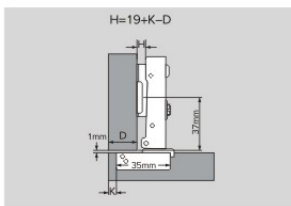

D:盖位计算值表 Overlay calculations

D	H	K	3	4	5	6	7
-2	18	19	20	21	22		
1	16	17	18	19	20		
2	14	15	16	17	18		
4	12	13	14	15	16		

D:盖位计算值表 Overlay calculations

D	H	K	3	4	5	6	7
-2	10	11	12	13	14		
0	8	9	10	11	12		
2	6	7	8	9	10		
4	4	5	6	7	8		

D:盖位计算值表 Overlay calculations

D	H	K	3	4	5	6	7
0	-1	-2	-3	-4	-5		
2	1	0	-1	-2	-3		
4	3	2	1	0	-1		

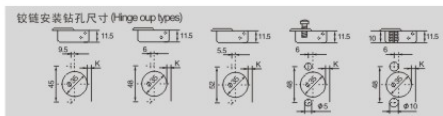

可选择底片
Choose Plate



直臂
FULL
OVERLAY



中弯
HALF
OVERLAY



大弯
INSERTED



02530

H:底座高度 D:侧板上所需盖位 K:门板外线与铰杯钻孔距离 A:门与侧板间隙

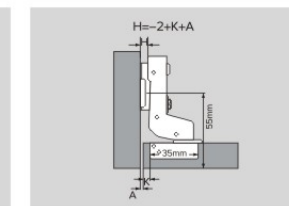
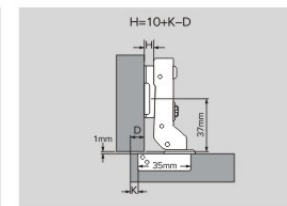
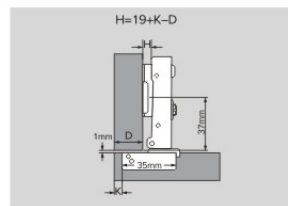

D:盖位计算值表 Overlay calculations

D	H	K	3	4	5	6	7
-2	18	19	20	21	22		
1	16	17	18	19	20		
2	14	15	16	17	18		
4	12	13	14	15	16		

D:盖位计算值表 Overlay calculations

D	H	K	3	4	5	6	7
-2	10	11	12	13	14		
0	8	9	10	11	12		
2	6	7	8	9	10		
4	4	5	6	7	8		

D:盖位计算值表 Overlay calculations

D	H	K	3	4	5	6	7
0	-1	-2	-3	-4	-5		
2	1	0	-1	-2	-3		
4	3	2	1	0	-1		

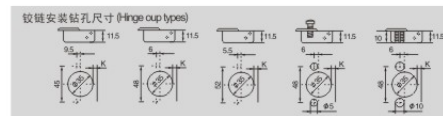

35 二段力双偏心阻尼铰链
φ35 Two way double eccentric adjustable soft closing hinge

- ◆ Double excentric adjustment
- ◆ Powerful buffering
- ◆ Smooth & Quietness



▶ 02344

▶ 02347



产品描述/Description

35 一段力滑入式阻尼铰链
φ35 One way slide on soft closing hinge

开启角度: 105度
铰杯高度: 11.3毫米
铰杯直径: 35毫米
门可选用板厚度: 14-24毫米

Open degree: 105°
Height of hinge cup: 11.3mm
Diameter of hinge cup: 35mm
Range of doors thickness: 14-24mm

直臂
FULL
OVERLAY



中弯
HALF
OVERLAY



大弯
INSERTED



02822

H:底座高度 D:侧板上所需盖位 K:门板外线与铰杯钻孔距离 A:门与侧板间隙

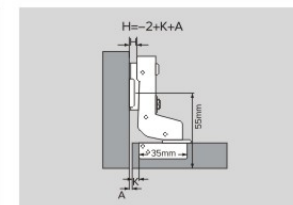
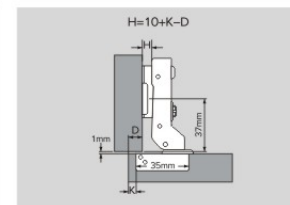
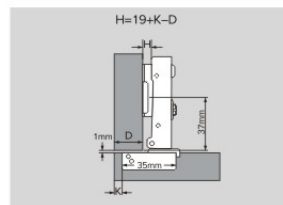

D:盖位计算值表 Overlay calculations

D	H	K	3	4	5	6	7
-2	18	19	20	21	22		
1	16	17	18	19	20		
2	14	15	16	17	18		
4	12	13	14	15	16		

D:盖位计算值表 Overlay calculations

D	H	K	3	4	5	6	7
-2	10	11	12	13	14		
0	8	9	10	11	12		
2	6	7	8	9	10		
4	4	5	6	7	8		

D:盖位计算值表 Overlay calculations

D	H	K	3	4	5	6	7
0	-1	-2	-3	-4	-5		
2	1	0	-1	-2	-3		
4	3	2	1	0	-1		

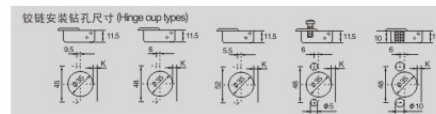



产品描述/Description

35闭尾固定阻尼铰链
φ35 Fixed soft closing hinge for glass door

开启角度: 105度
铰杯高度: 11.3毫米
铰杯直径: 35毫米
门可选用板厚度: 14-24毫米

Open degree: 105°
Height of hinge cup: 11.3mm
Diameter of hinge cup: 35mm
Range of doors thickness: 14-24mm



产品描述/Description

35开尾固定阻尼铰链
φ35 Cotter Fixed soft closing hinge for glass door

开启角度: 105度
铰杯高度: 11.3毫米
铰杯直径: 35毫米
门可选用板厚度: 14-24毫米

Open degree: 105°
Height of hinge cup: 11.3mm
Diameter of hinge cup: 35mm
Range of doors thickness: 14-24mm

直臂
FULL
OVERLAY



中弯
HALF
OVERLAY



大弯
INSERTED



02527

H:底座高度 D:侧板上所需盖位 K:门板外线与铰杯钻孔距离 A:门与侧板间隙

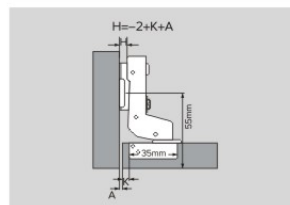
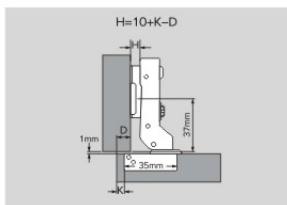
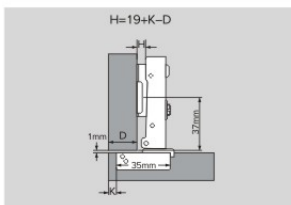

D:盖位计算值表 Overlay calculations

D	H	K	3	4	5	6	7
-2	18	19	20	21	22		
1	16	17	18	19	20		
2	14	15	16	17	18		
4	12	13	14	15	16		

D:盖位计算值表 Overlay calculations

D	H	K	3	4	5	6	7
-2	10	11	12	13	14		
0	8	9	10	11	12		
2	6	7	8	9	10		
4	4	5	6	7	8		

D:盖位计算值表 Overlay calculations

D	H	K	3	4	5	6	7
0	-1	-2	-3	-4	-5		
2	1	0	-1	-2	-3		
4	3	2	1	0	-1		

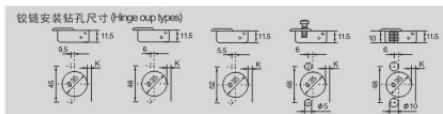

直臂
FULL
OVERLAY



中弯
HALF
OVERLAY



大弯
INSERTED



02529

H:底座高度 D:侧板上所需盖位 K:门板外线与铰杯钻孔距离 A:门与侧板间隙

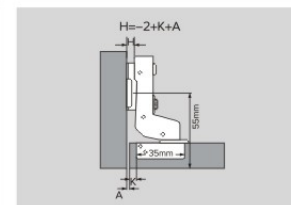
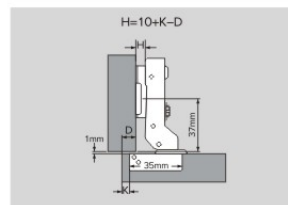
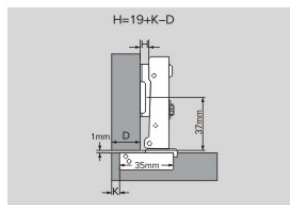

D:盖位计算值表 Overlay calculations

D	H	K	3	4	5	6	7
-2	18	19	20	21	22		
1	16	17	18	19	20		
2	14	15	16	17	18		
4	12	13	14	15	16		

D:盖位计算值表 Overlay calculations

D	H	K	3	4	5	6	7
-2	10	11	12	13	14		
0	8	9	10	11	12		
2	6	7	8	9	10		
4	4	5	6	7	8		

D:盖位计算值表 Overlay calculations

D	H	K	3	4	5	6	7
0	-1	-2	-3	-4	-5		
2	1	0	-1	-2	-3		
4	3	2	1	0	-1		

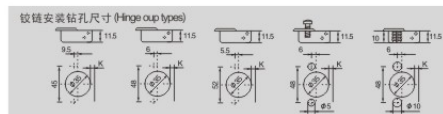



产品描述/Description

35 固定玻璃铰链
φ35 Fixed soft closing hinge for glass door

开启角度: 105度
铰杯高度: 11.3毫米
铰杯直径: 35毫米
门可选用板厚度: 14-24毫米

Open degree: 105°
Height of hinge cup: 11.3mm
Diameter of hinge cup: 35mm
Range of doors thickness: 14-24mm

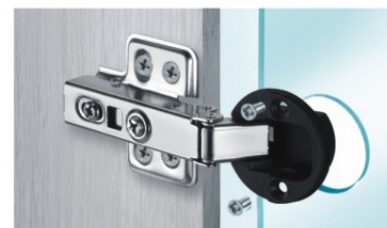

产品描述/Description

35 快装阻尼玻璃铰链
φ35 Clip on soft closing hinge for glass door

开启角度: 105度
铰杯高度: 11.3毫米
铰杯直径: 35毫米
门可选用板厚度: 14-24毫米

Open degree: 105°
Height of hinge cup: 11.3mm
Diameter of hinge cup: 35mm
Range of doors thickness: 14-24mm

直臂
FULL
OVERLAY



中弯
HALF
OVERLAY



大弯
INSERTED



02528

H:底座高度 D:侧板上所需盖位 K:门板外线与铰杯钻孔距离 A:门与侧板间隙

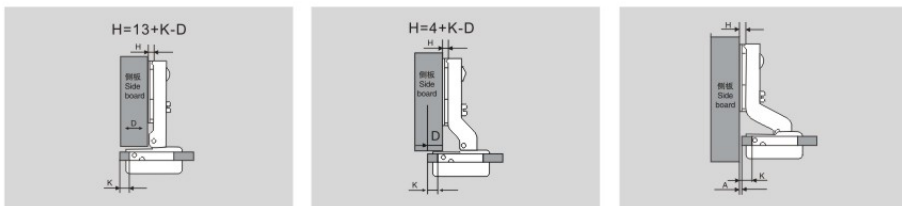

D:盖位计算值表 Overlay calculations

D	H	K	3	4	5	6	7
0	16	17	18	19	20		
2	14	15	16	17	18		
4	12	13	14	15	16		

D:盖位计算值表 Overlay calculations

D	H	K	3	4	5	6	7
0	7	8	9	10	11		
2	5	6	7	8	9		
4	3	4	5	6	7		

D:盖位计算值表 Overlay calculations

D	H	K	3	4	5	6	7
0	2	1	0	-1	-2		
2	4	3	2	1	0		
4	6	5	4	3	2		

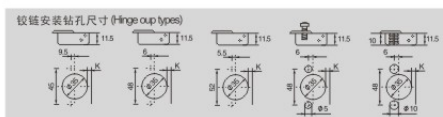

可选择底片
Choose Plate



直臂
FULL
OVERLAY



中弯
HALF
OVERLAY



大弯
INSERTED



02346

H:底座高度 D:侧板上所需盖位 K:门板外线与铰杯钻孔距离 A:门与侧板间隙

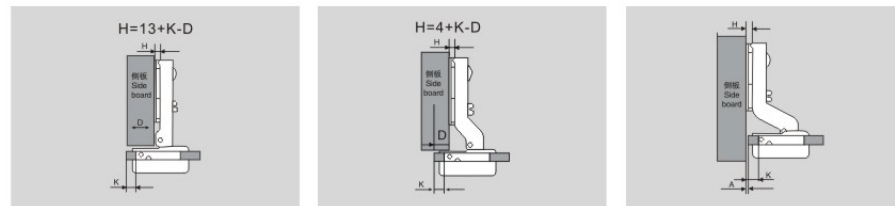

D:盖位计算值表 Overlay calculations

D	H	K	3	4	5	6	7
0	16	17	18	19	20		
2	14	15	16	17	18		
4	12	13	14	15	16		

D:盖位计算值表 Overlay calculations

D	H	K	3	4	5	6	7
0	7	8	9	10	11		
2	5	6	7	8	9		
4	3	4	5	6	7		

D:盖位计算值表 Overlay calculations

D	H	K	3	4	5	6	7
0	2	1	0	-1	-2		
2	4	3	2	1	0		
4	6	5	4	3	2		

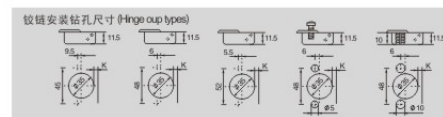

可选择底片
Choose Plate





产品描述/Description

35二段力快装双偏心阻尼铰链
φ35 Two way double eccentric adjustable soft closing hinge

开角度: 105度 Open degree: 105°
铰杯高度: 11.3毫米 Height of hinge cup: 11.3mm
铰杯直径: 35毫米 Diameter of hinge cup: 35mm
门可选用板厚度: 14-24毫米 Range of doors thickness: 14-24mm



产品描述/Description

35一段力弧形阻尼快装铰链
φ35 One way soft closing clip-on hinge

开角度: 105度 Open degree: 105°
铰杯高度: 11.3毫米 Height of hinge cup: 11.3mm
铰杯直径: 35毫米 Diameter of hinge cup: 35mm
门可选用板厚度: 14-24毫米 Range of doors thickness: 14-24mm

直臂
FULL
OVERLAY



中弯
HALF
OVERLAY



大弯
INSERTED



直臂
FULL
OVERLAY



中弯
HALF
OVERLAY



大弯
INSERTED



02344

H:底座高度 D:侧板上所需盖位 K:门板外线与铰杯钻孔距离 A:门与侧板间隙

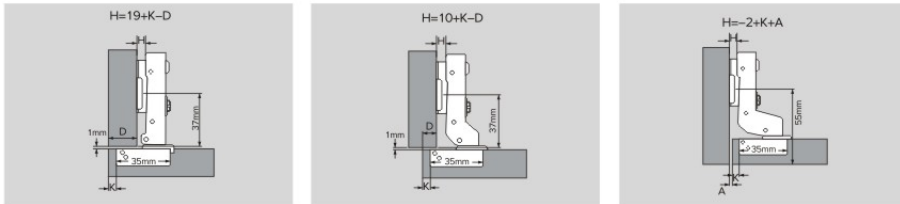

D:盖位计算值表 Overlay calculations

D	H	K	3	4	5	6	7
-2	18	19	20	21	22		
1	16	17	18	19	20		
2	14	15	16	17	18		
4	12	13	14	15	16		

D:盖位计算值表 Overlay calculations

D	H	K	3	4	5	6	7
-2	10	11	12	13	14		
0	8	9	10	11	12		
2	6	7	8	9	10		
4	4	5	6	7	8		

D:盖位计算值表 Overlay calculations

D	H	K	3	4	5	6	7
0	-1	-2	-3	-4	-5		
2	1	0	-1	-2	-3		
4	3	2	1	0	-1		

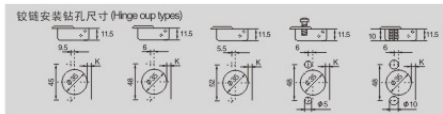

02345

H:底座高度 D:侧板上所需盖位 K:门板外线与铰杯钻孔距离 A:门与侧板间隙

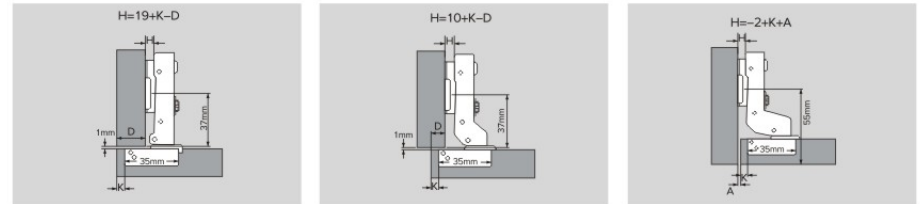

D:盖位计算值表 Overlay calculations

D	H	K	3	4	5	6	7
-2	18	19	20	21	22		
1	16	17	18	19	20		
2	14	15	16	17	18		
4	12	13	14	15	16		

D:盖位计算值表 Overlay calculations

D	H	K	3	4	5	6	7
-2	10	11	12	13	14		
0	8	9	10	11	12		
2	6	7	8	9	10		
4	4	5	6	7	8		

D:盖位计算值表 Overlay calculations

D	H	K	3	4	5	6	7
0	-1	-2	-3	-4	-5		
2	1	0	-1	-2	-3		
4	3	2	1	0	-1		

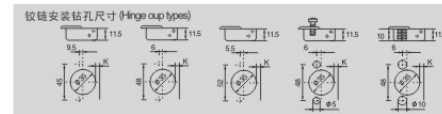



产品描述/Description

35 二段力固装阻尼铰链
φ35 Two way fixed soft closing hinge

开启角度: 105度	Open degree: 105°
铰杯高度: 11.3毫米	Height of hinge cup: 11.3mm
铰杯直径: 35毫米	Diameter of hinge cup: 35mm
门可选用板厚度: 14-24毫米	Range of doors thickness: 14-24mm

直臂
FULL OVERLAY



中弯
HALF OVERLAY



大弯
INSERTED



02523

H:底座高度 D:侧板上所需盖位 K:门板外线与铰杯钻孔距离 A:门与侧板间隙

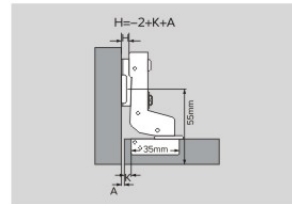
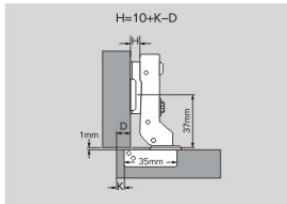
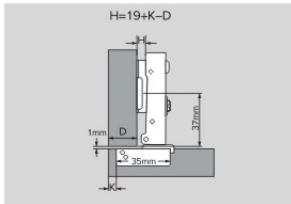

D:盖位计算值表 Overlay calculations

D	H	K	3	4	5	6	7
-2	18	19	20	21	22		
1	16	17	18	19	20		
2	14	15	16	17	18		
4	12	13	14	15	16		

D:盖位计算值表 Overlay calculations

D	H	K	3	4	5	6	7
-2	10	11	12	13	14		
0	8	9	10	11	12		
2	6	7	8	9	10		
4	4	5	6	7	8		

D:盖位计算值表 Overlay calculations

D	H	K	3	4	5	6	7
0	-1	-2	-3	-4	-5		
2	1	0	-1	-2	-3		
4	3	2	1	0	-1		

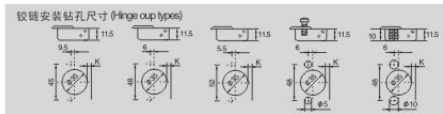

35 调速阻尼铰链
φ35 Adjustable soft closing hinge



02324



产品描述/Description

35 短臂铰链/ ϕ 35 Short arm hinge

开启角度: 105度
铰杯高度: 11.3毫米
铰杯直径: 35毫米
门可选用板厚度: 14-24毫米

Open degree: 105°
Height of hinge cup: 11.3mm
Diameter of hinge cup: 35mm
Range of doors thickness: 14-24mm



产品描述/Description

35 美式铰链/ ϕ 35 American type hinge

开启角度: 105度
铰杯高度: 11.3毫米
铰杯直径: 35毫米
门可选用板厚度: 14-24毫米

Open degree: 105°
Height of hinge cup: 11.3mm
Diameter of hinge cup: 35mm
Range of doors thickness: 14-24mm

1/2"



5/8"



02745

H:底座高度 D:侧板上所需盖位 K:门板外线与铰杯钻孔距离 A:门与侧板间隙

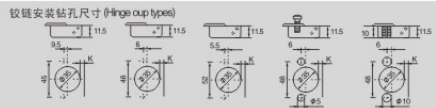
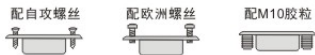
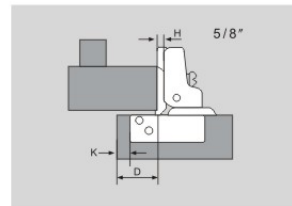
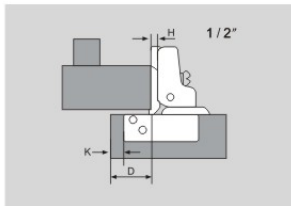

盖位 Overlay

7-16" (11.1mm)
1/2" (12.7mm)
5/8" (15.9mm)

02746



盖位 Overlay

1" (25.4mm)
1-1/4" (31.7mm)
1-5/16" (33.3mm)
1-3/8" (34.9mm)
1-1/2" (38.1mm)

02747



盖位 Overlay

1" (25.4mm)
1-1/4" (31.7mm)
1-5/16" (33.3mm)
1-3/8" (34.9mm)
1-7/16" (36.5mm)
1-1/2" (38.1mm)

02748

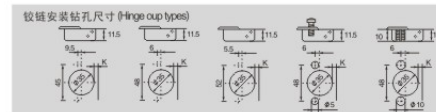



产品描述/Description

35 不锈钢快装阻尼铰链
φ35 Stainless steel soft closing hinge

开启角度: 105度 Open degree: 105°
铰杯高度: 11.3毫米 Height of hinge cup: 11.3mm
铰杯直径: 35毫米 Diameter of hinge cup: 35mm
门可选用板厚度: 14-24毫米 Range of doors thickness: 14-24mm



产品描述/Description

35 30°/45°/90°/135° 开口铰链
φ35 30°/45°/90°/135° angle hinge

开启角度: 30/45/90/135度 Open degree: 30°/45°/90°/135°
铰杯高度: 11.3毫米 Height of hinge cup: 11.3mm
铰杯直径: 35毫米 Diameter of hinge cup: 35mm
门可选用板厚度: 14-24毫米 Range of doors thickness: 14-24mm

直臂
FULL
OVERLAY



中弯
HALF
OVERLAY



大弯
INSERTED



30°
Hinge



45°
Hinge



90°
Hinge

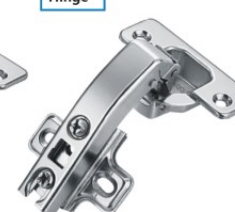

135°
Hinge

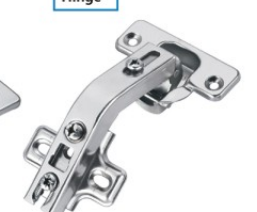

02530

H:底座高度 D:侧板上所需盖位 K:门板外线与铰杯钻孔距离 A:门与侧板间隙

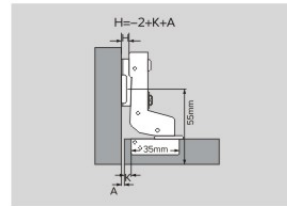
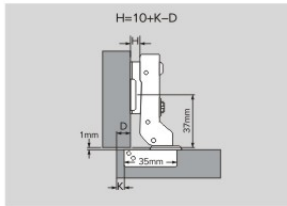
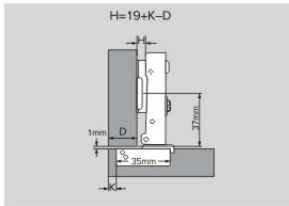

D:盖位计算值表 Overlay calculations

D	H	K	3	4	5	6	7
-2	18	19	20	21	22		
1	16	17	18	19	20		
2	14	15	16	17	18		
4	12	13	14	15	16		

D:盖位计算值表 Overlay calculations

D	H	K	3	4	5	6	7
-2	10	11	12	13	14		
0	8	9	10	11	12		
2	6	7	8	9	10		
4	4	5	6	7	8		

D:盖位计算值表 Overlay calculations

D	H	K	3	4	5	6	7
0	-1	-2	-3	-4	-5		
2	1	0	-1	-2	-3		
4	3	2	1	0	-1		

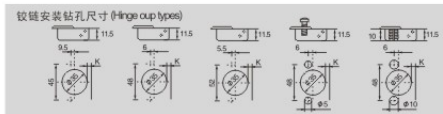

可选择底片
Choose Plate



H:底座高度 D:侧板上所需盖位 K:门板外线与铰杯钻孔距离 A:门与侧板间隙

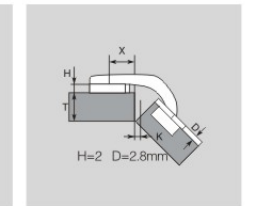
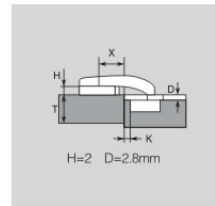
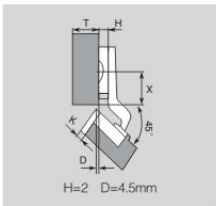
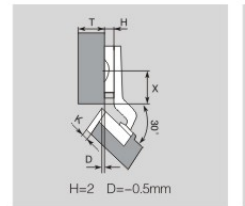

D:盖位计算值表 Overlay calculations

H	4	5	6	7
0	37	15/36	24/35	33/34
2	37	25/36	34/35	43/44
4	37	25/36	34/35	43/44
6	37	25/36	34/35	43/44
X				

D:盖位计算值表 Overlay calculations

H	4	5	6	7
0	37	65/36	72/35	79/34
2	37	45/36	52/35	59/34
4	37	25/36	32/35	39/34
6	37	05/36	12/35	19/34
X				

D:盖位计算值表 Overlay calculations

H	4	5	6	7
0	20	48/19	48	
2	20	28/19	28	
4	20	08/19	08	
6	20	-12/19	-12	
X				

D:盖位计算值表 Overlay calculations

H	4	5	6	7
0	20	48/19	48	
2	20	28/19	28	
4	20	08/19	08	
6	20	-12/19	-12	
X				

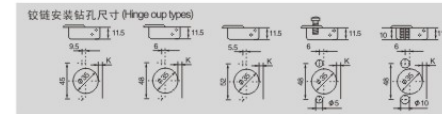
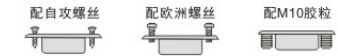

可选择底片
Choose Plate



35 165°开口铰链
φ35 165°angle hinge

- ◆ Big opening angle
- ◆ Smooth & silent
- ◆ High quality



02140



产品描述/Description

35 30°/45°/90°快装阻尼铰链
φ35 30°/45°/90° Clip on soft closing angle hinge

开启角度: 30/45/90度
铰杯高度: 11.3毫米
铰杯直径: 35毫米
门可选用板厚度: 14-24毫米

Open degree: 30°/45°/90°
Height of hinge cup: 11.3mm
Diameter of hinge cup: 35mm
Range of doors thickness: 14-24mm

30°
Hinge



02337

45°
Hinge



02338

90°
Hinge



02339

H:底座高度 D:侧板上所需盖位 K:门板外线与铰杯钻孔距离 A:门与侧板间隙

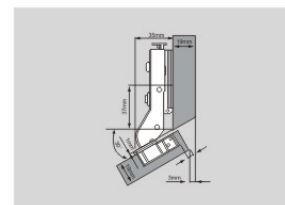

D:盖位计算值表 Overlay calculations

H	K				D
	4	5	6	7	
0 37	1.5 36	2.4 35	3.3 34	4.2	D
2 37	0.5 36	0.4 35	1.3 34	2.2	
4 37	2.5 36	1.6 35	0.7 34	0.2	
6 37	4.5 36	3.6 35	2.7 34	1.8	
X					

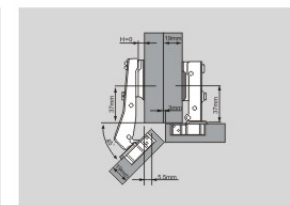

D:盖位计算值表 Overlay calculations

H	K				D
	4	5	6	7	
0 37	6.5 36	7.2 35	7.9 34	8.6	D
2 37	4.5 36	6.2 35	5.9 34	6.6	
4 37	2.5 36	3.2 35	3.9 34	4.6	
6 37	0.5 36	1.2 35	1.9 34	2.6	
X					

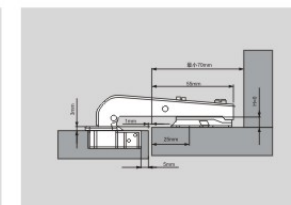

D:盖位计算值表 Overlay calculations

H	K				D
	4	5	6	7	
0 20	4.8 19	4.8			D
2 20	2.8 19	2.8			
4 20	0.8 19	0.8			
6 20	1.2 19	1.2			
X					



配自攻螺丝



配欧洲螺丝



配M10胶粒



配自攻螺丝



配欧洲螺丝



配M10胶粒

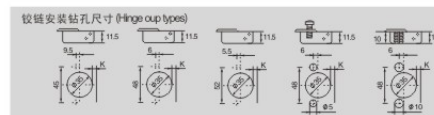

可选择底片
Choose Plate





产品描述/Description

35 165°阻尼快装铰链/165° Clip on soft closing hinge

开启角度: 165度
铰杯高度: 11.3毫米
铰杯直径: 35毫米
门可选用板厚度: 14-24毫米

Open degree: 165°
Height of hinge cup: 11.3mm
Diameter of hinge cup: 35mm
Range of doors thickness: 14-24mm



产品描述/Description

35 -30°/-45°/40°杯开口铰链
φ 35 -30°/-45°/40 angle hinge

开启角度: -30°/-45°/105度
铰杯高度: 11.3毫米
铰杯直径: 35/40毫米
门可选用板厚度: 14-24毫米

Open degree: -30°/-45°/105°
Height of hinge cup: 11.3mm
Diameter of hinge cup: 35/40mm
Range of doors thickness: 14-24mm

直臂
FULL
OVERLAY



中弯
HALF
OVERLAY



大弯
INSERTED

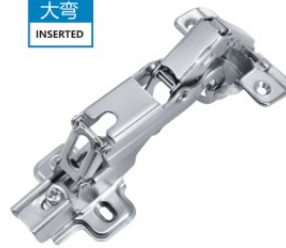

02342

H:底座高度 D:侧板上所需盖位 K:门板外线与铰杯钻孔距离 A:门与侧板间隙

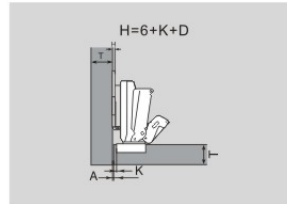
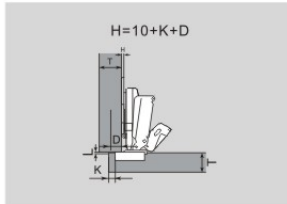
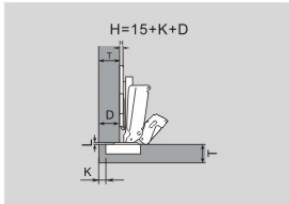

D:盖位计算值表 Overlay calculations

D	H	K	3	4	5	6	7
0	18	19	20	21	22		
2	16	17	18	19	20		
4	14	15	16	17	18		

D:盖位计算值表 Overlay calculations

D	H	K	3	4	5	6	7
0	9	10	11	12	13		
2	7	8	9	10	11		
4	5	6	7	8	9		

D:盖位计算值表 Overlay calculations

D	H	K	3	4	5	6	7
0	-1	-2	-3	-4	-5		
2	1	0	-1	-2	-3		
4	3	2	1	0	-1		

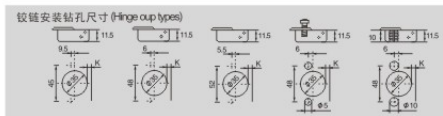

-30°
Hinge



02143

-45°
Hinge



02144

40°
Hinge



02822

H:底座高度 D:侧板上所需盖位 K:门板外线与铰杯钻孔距离 A:门与侧板间隙

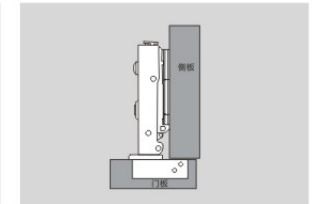
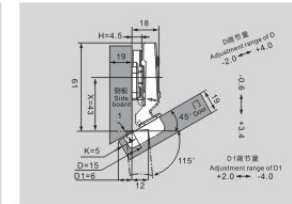
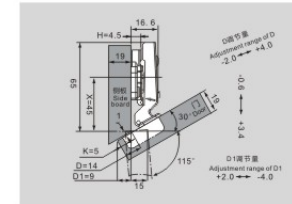

D:盖位计算值表 Overlay calculations

D	H	K	3	4	5	6	7
16	0.6	0.6	0.6	0.6	0.6		
17	0.6	0.6	0.6	0.6	0.6		
18	0.7	0.7	0.7	0.7	0.7		
19	0.9	0.9	0.9	0.9	0.9		

D:盖位计算值表 Overlay calculations

D	H	K	3	4	5	6	7
16	0.6	0.6	0.6	0.6	0.6		
17	0.6	0.6	0.6	0.6	0.6		
18	0.7	0.7	0.7	0.7	0.7		
19	0.9	0.9	0.9	0.9	0.9		

D:盖位计算值表 Overlay calculations

D	H	K	3	4	5	...	11
H=0	21	22	23	...	29		
H=3	18	19	20	...	26		
H=5	16	16	18	...	24		

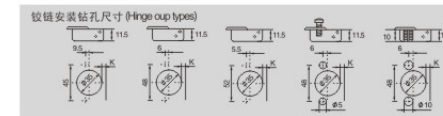

可选择底片
Choose Plate



Exquisite craft Precision equipment

Excellent quality and durable material achievements of the perfect product



产品描述/Description

17 二节侧装钢珠滑轨 W17mm 3/4 extension side mounting ball bearing slide

规格: 250-600毫米/10-24寸
安装宽度: 12.7毫米
可承载负荷: 15公斤
表面处理: 电镀白、黑
主要材质: 冷轧钢板

Size: 250-600mm/10-24 inch
Side space: 12.7mm
Loading capacity: 15kg
Finish: zinc white, zinc black
Main material: cold-rolled steel

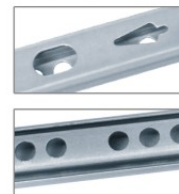

03101



产品描述/Description

27 二节侧装钢珠滑轨 W27mm 3/4 extension side mounting ball bearing slide

规格: 250-600毫米/10-24寸
安装宽度: 12.7毫米
可承载负荷: 15公斤
表面处理: 电镀白、黑
主要材质: 冷轧钢板

Size: 250-600mm/10-24 inch
Side space: 12.7mm
Loading capacity: 15kg
Finish: zinc white, zinc black
Main material: cold-rolled steel



03201



产品描述/Description

27 侧装键盘钢珠滑轨
W27mm 3/4 extension side mounting keyboard slide

规格: 250-600毫米/10-24寸	Size: 250-600mm/10-24 inch
安装宽度: 12.7毫米	Side space: 12.7mm
可承载负荷: 35公斤	Loading capacity: 35kg
表面处理: 电镀白、黑	Finish: zinc white, zinc black
主要材质: 冷轧钢板	Main material: cold-rolled steel

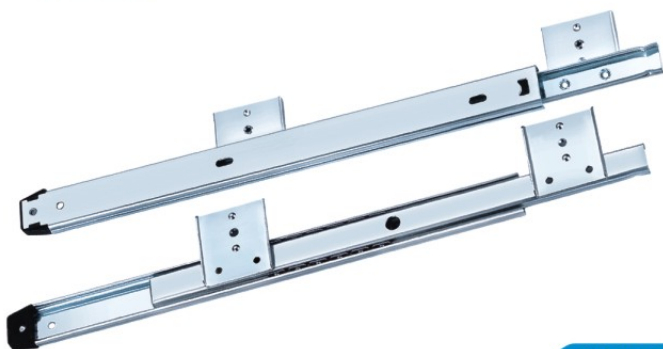

03203



产品描述/Description

30 三节侧装钢珠滑轨
W30mm full extension side mounting ball bearing slide

规格: 250-700毫米/10-28寸	Size: 250-700mm/10-28 inch
安装宽度: 12.7毫米	Side space: 12.7mm
可承载负荷: 45公斤	Loading capacity: 45kg
表面处理: 电镀白、黑	Finish: zinc white, zinc black
主要材质: 冷轧钢板	Main material: cold-rolled steel



03251



产品描述/Description

27 底装键盘钢珠滑轨
W27mm 3/4 extension bottom mounting keyboard slide

规格: 250-600毫米/10-24寸	Size: 250-600mm/10-24 inch
安装宽度: 12.7毫米	Side space: 12.7mm
可承载负荷: 35公斤	Loading capacity: 35kg
表面处理: 电镀白、黑	Finish: zinc white, zinc black
主要材质: 冷轧钢板	Main material: cold-rolled steel

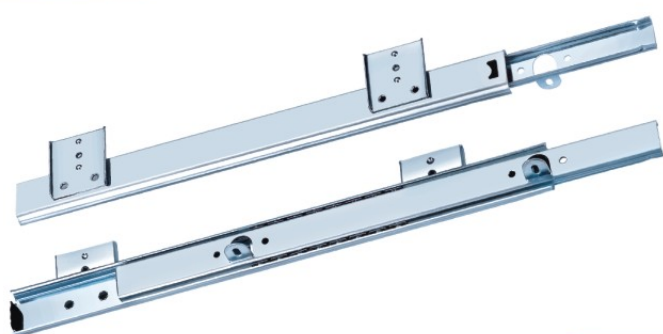
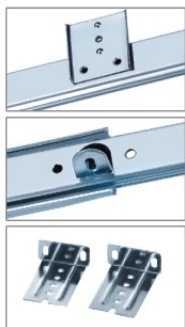

03204

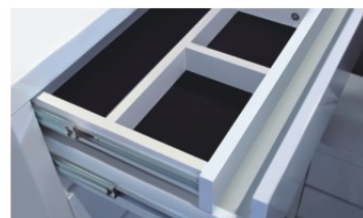

产品描述/Description

36 钢抽钢珠滑轨
W36mm full extension side mounting ball bearing slide for steel drawer

规格: 250-700毫米/10-28寸	Size: 250-700mm/10-28 inch
安装宽度: 12.7毫米	Side space: 12.7mm
可承载负荷: 45公斤	Loading capacity: 45kg
表面处理: 电镀白、黑	Finish: zinc white, zinc black
主要材质: 冷轧钢板	Main material: cold-rolled steel



03503



产品描述/Description

35 侧装键盘钢珠滑轨
W35mm full extension side mounting ball bearing slide

规格: 250-600毫米/10-24寸	Size: 250-600mm/10-24 inch
安装宽度: 12.7毫米	Side space: 12.7mm
可承载负荷: 35公斤	Loading capacity: 35kg
表面处理: 电镀白、黑	Finish: zinc white, zinc black
主要材质: 冷轧钢板	Main material: cold-rolled steel

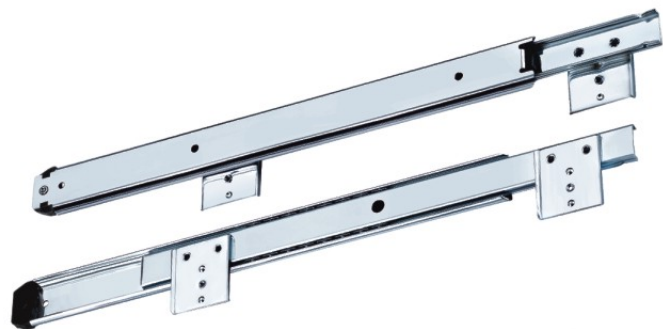
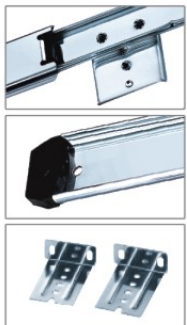

03305

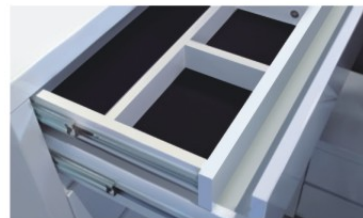

产品描述/Description

35 三节侧装钢珠滑轨
W35mm full extension side mounting keyboard slide

规格: 250-700毫米/10-28寸	Size: 250-700mm/10-28 inch
安装宽度: 12.7毫米	Side space: 12.7mm
可承载负荷: 30公斤	Loading capacity: 30kg
表面处理: 电镀白、黑	Finish: zinc white, zinc black
主要材质: 冷轧钢板	Main material: cold-rolled steel



03303



产品描述/Description

35 底装键盘钢珠滑轨
W35mm full extension bottom mounting ball bearing slide

规格: 250-600毫米/10-24寸	Size: 250-600mm/10-24 inch
安装宽度: 12.7毫米	Side space: 12.7mm
可承载负荷: 35公斤	Loading capacity: 35kg
表面处理: 电镀白、黑	Finish: zinc white, zinc black
主要材质: 冷轧钢板	Main material: cold-rolled steel



03304

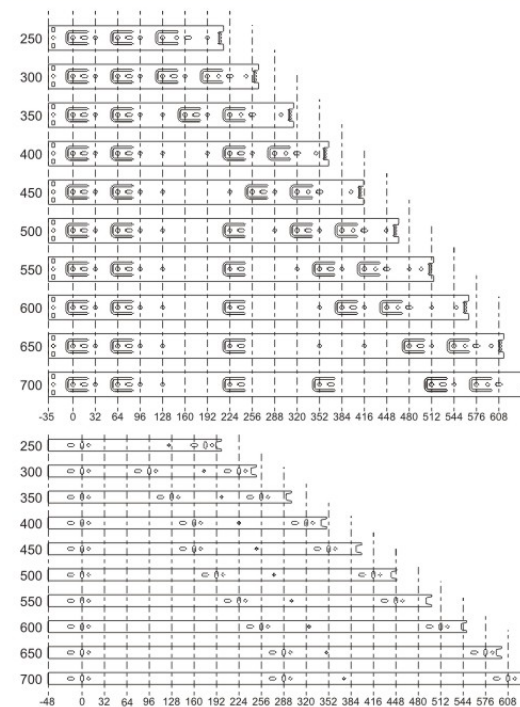

可选长度 Optional length

10''/250mm
12''/300mm
14''/350mm
16''/400mm
18''/450mm
20''/500mm
22''/550mm
24''/600mm
26''/650mm
28''/700mm



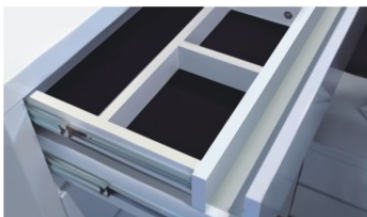

产品描述/Description

40 三节侧装钢珠滑轨
W40mm full extension side mounting ball bearing slide

规格: 250-650毫米/10-26寸 Size: 250-650mm/10-26 inch
 安装宽度: 12.7毫米 Side space: 12.7mm
 可承载负荷: 45公斤 Loading capacity: 45kg
 表面处理: 电镀白、黑 Finish: zinc white, zinc black
 主要材质: 冷轧钢板 Main material: cold-rolled steel



03261

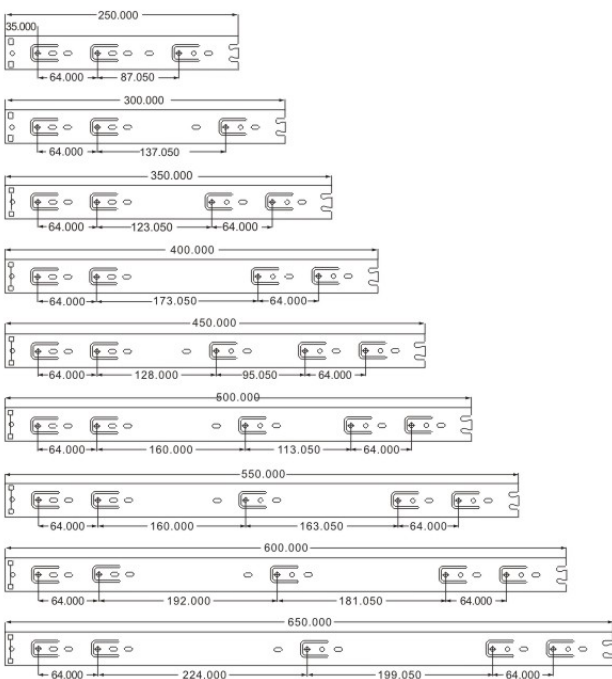

可选长度 Optional length

10''/250mm
12''/300mm
14''/350mm
16''/400mm
18''/450mm
20''/500mm
22''/550mm
24''/600mm
26''/650mm

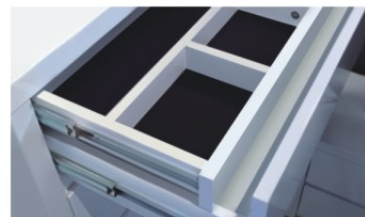

产品描述/Description

42 三节侧装钢珠滑轨
W42mm full extension side mounting ball bearing slide

规格: 250-700毫米/10-28寸 Size: 250-700mm/10-28 inch
 安装宽度: 12.7毫米 Side space: 12.7mm
 可承载负荷: 45公斤 Loading capacity: 45kg
 表面处理: 电镀白、黑 Finish: zinc white, zinc black
 主要材质: 冷轧钢板 Main material: cold-rolled steel



03407

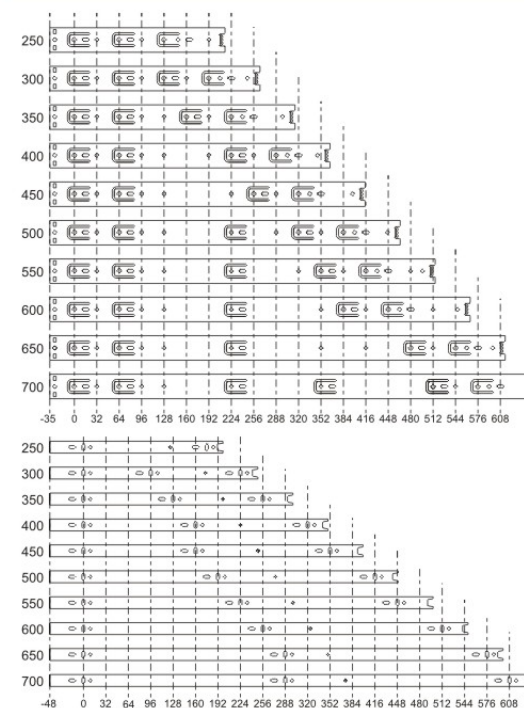

可选长度 Optional length

10''/250mm
12''/300mm
14''/350mm
16''/400mm
18''/450mm
20''/500mm
22''/550mm
24''/600mm
26''/650mm
28''/700mm



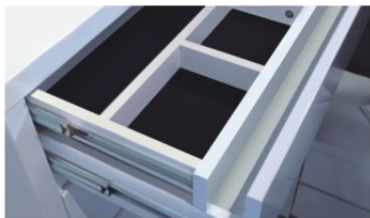

产品描述/Description

45 三节侧装钢珠滑轨
W45mm full extension side mounting ball bearing slide

规格: 250-700毫米/10-28寸
安装宽度: 12.7毫米
可承载负荷: 45公斤
表面处理: 电镀白、黑
主要材质: 冷轧钢板

Size: 250-700mm/10-28 inch
Side space: 12.7mm
Loading capacity: 45kg
Finish: zinc white, zinc black
Main material: cold-rolled steel



03401

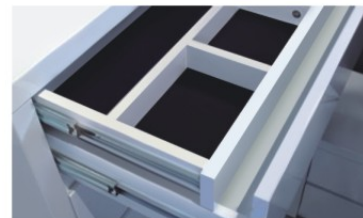
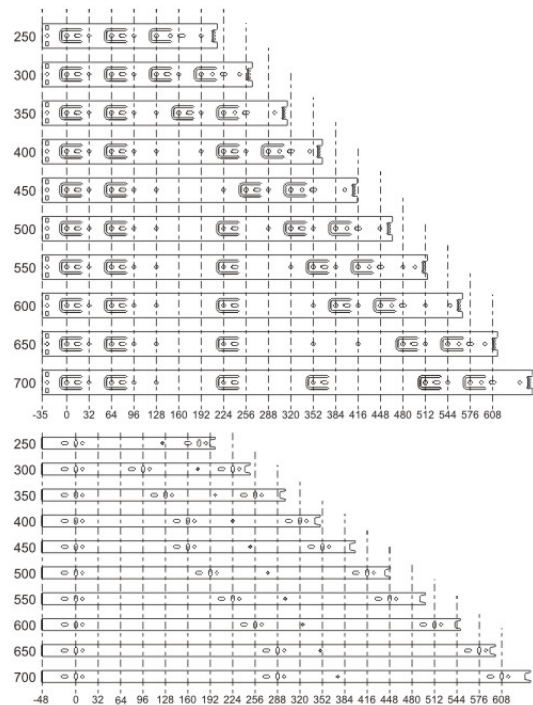

产品描述/Description

45 钢抽钢珠滑轨
W45mm full extension side mounting ball bearing slide for steel drawer

规格: 250-700毫米/10-28寸
安装宽度: 12.7毫米
可承载负荷: 45公斤
表面处理: 电镀白、黑
主要材质: 冷轧钢板

Size: 250-700mm/10-28 inch
Side space: 12.7mm
Loading capacity: 45kg
Finish: zinc white, zinc black
Main material: cold-rolled steel

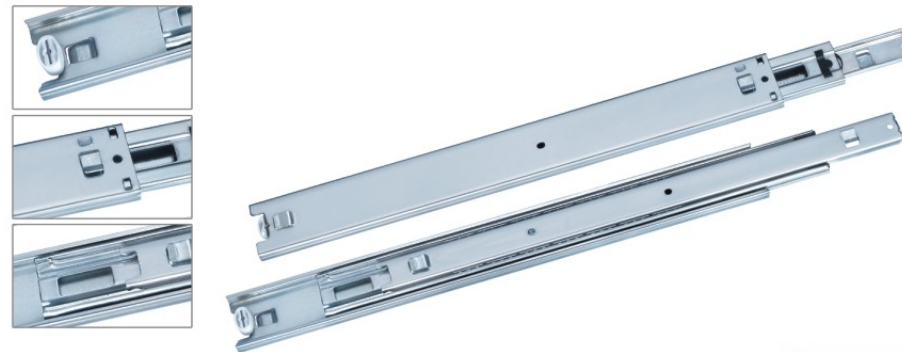

03502

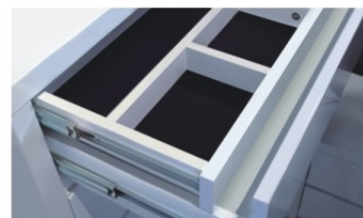

产品描述/Description

45自关钢珠滑轨
W45mm full extension self closing ball bearing slide

规格: 250-700毫米/10-28寸
安装宽度: 12.7毫米
可承载负荷: 45公斤
表面处理: 电镀白、黑
主要材质: 冷轧钢板

Size: 250-700mm/10-28 inch
Side space: 12.7mm
Loading rate: 45kg
Finish: zinc white, zinc black
Main material: cold-rolled steel



03406

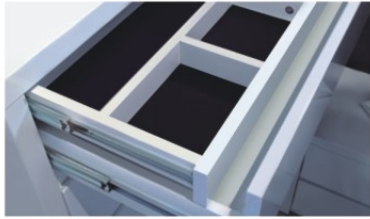

产品描述/Description

45 阻尼缓冲钢珠滑轨
W45mm full extension soft closing ball bearing slide

规格: 250-700毫米/10-28寸
安装宽度: 12.7毫米
可承载负荷: 45公斤
表面处理: 电镀白、黑
主要材质: 冷轧钢板

Size: 250-700mm/10-28 inch
Side space: 12.7mm
Loading capacity: 45kg
Finish: zinc white, zinc black
Main material: cold-rolled steel

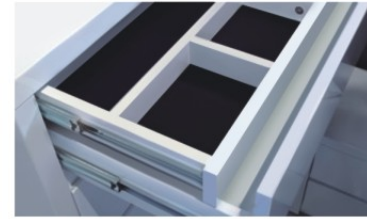

产品描述/Description

45 反弹钢珠滑轨
W45mm full extension push-to-open ball bearing slide

规格: 250-700毫米/10-28寸
安装宽度: 12.7毫米
可承载负荷: 45公斤
表面处理: 电镀白、黑
主要材质: 冷轧钢板

Size: 250-700mm/10-28 inch
Side space: 12.7mm
Loading capacity: 45kg
Finish: zinc white, zinc black
Main material: cold-rolled steel

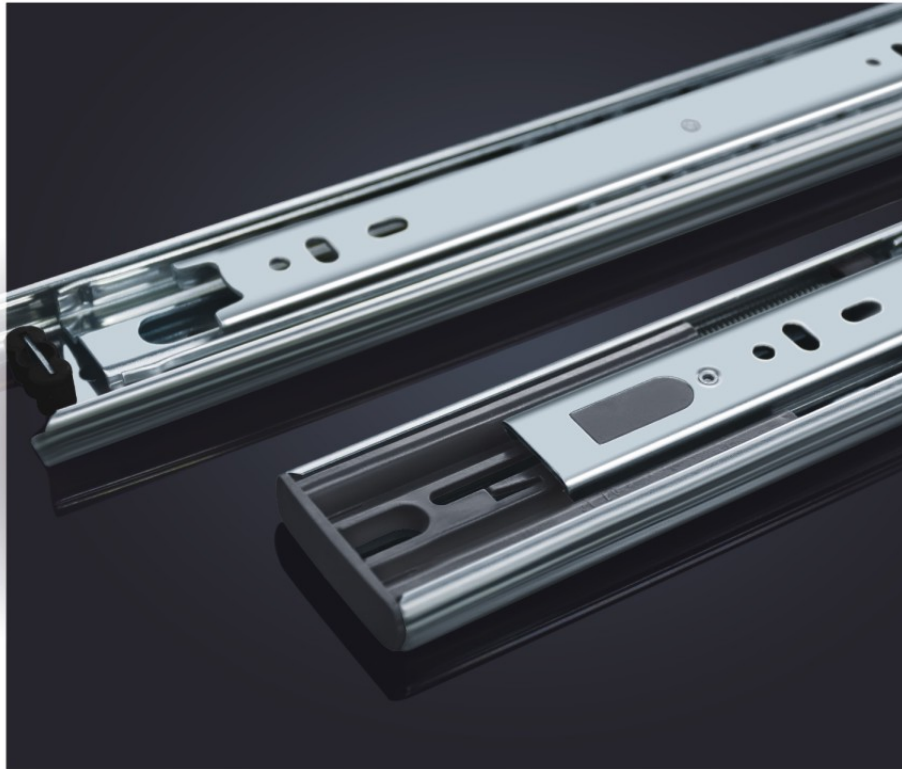

03407

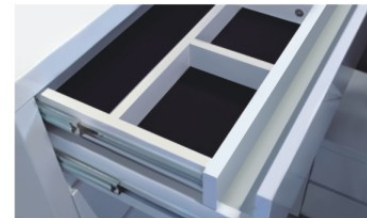

产品描述/Description

40三节侧装不锈钢滑轨
W40mm full extension stainless steel ball bearing slide

规格: 250-700毫米/10-28寸
安装宽度: 12.7毫米
可承载负荷: 45公斤
表面处理: 抛光
主要材质: 不锈钢-304

Size: 250-700mm/10-28inch
Side space: 12.7mm
Loading capacity: 45kg
Finish: polishing
Main material: stainless steel-304



03262

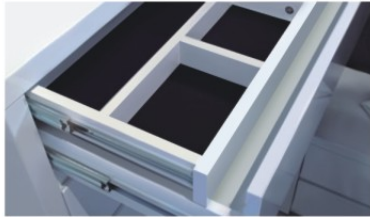

产品描述/Description

45三节侧装不锈钢滑轨
W45mm full extension stainless steel ball bearing slide

规格: 250-700毫米/10-28寸	Size: 250-700mm/10-28inch
安装宽度: 12.7毫米	Side space: 12.7mm
可承载负荷: 45公斤	Loading capacity: 45kg
表面处理: 抛光	Finish: polishing
主要材质: 不锈钢-304	Main material: stainless steel-304

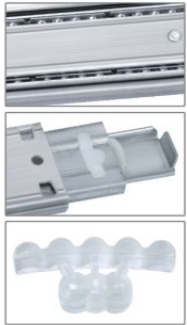

03408

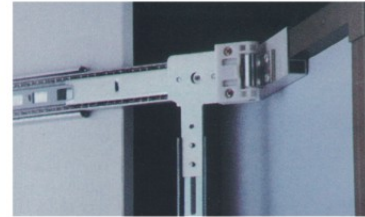

产品描述/Description

镜轨 Glass slide

规格: 250-600毫米/10-24寸	Size: 250-600mm/10-24 rich
安装宽度: 12.7毫米	Side space: 12.7mm
可承载负荷: 45公斤	Loading capacity: 45kg
表面处理: 电镀白、黑	Finish: zinc white, zinc black
主要材质: 冷轧钢板	Main material: cold-rolled steel



03601

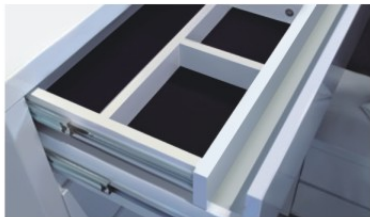

产品描述/Description

45三节侧装不锈钢阻尼钢珠滑轨
W45mm full extension stainless steel soft close ball bearing slide

规格: 250-700毫米/10-28寸	Size: 250-700mm/10-28inch
安装宽度: 12.7毫米	Side space: 12.7mm
可承载负荷: 45公斤	Loading capacity: 45kg
表面处理: 抛光	Finish: polishing
主要材质: 不锈钢-304	Main material: stainless steel-304



03409



产品描述/Description

餐台滑轨 Table slide

规格: 250-600毫米/10-24寸	Size: 250-600mm/10-24 rich
安装宽度: 12.7毫米	Side space: 12.7mm
可承载负荷: 45公斤	Loading capacity: 45kg
表面处理: 电镀白、黑	Finish: zinc white, zinc black
主要材质: 冷轧钢板	Main material: cold-rolled steel



03501

03502



产品描述/Description

二节阻尼隐藏滑轨 带销钉
3/4 extension soft closing concealed slide with pin fixing

隐藏式全拉出缓冲导轨
动态负载: 30kg(18")
材质: 镀锌钢板
材料厚度(上/中/下轨):1.0x1.5x1.8mm
带快速折装扣手, 抽屉可快速安装和拆卸
抽屉面板高度间隙可调1-3mm

Three-fold soft close concealed slide
Loading capacity: 30kg(18")
Material: Galvanized sheet
Thickness of Material(1.0/1.5/1.8mm)
Tool-free quick Installation
Drawer height adjustable by 1-3mm

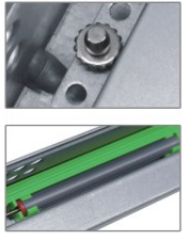

03614

侧轨安装孔位置Side rail mounting hole location

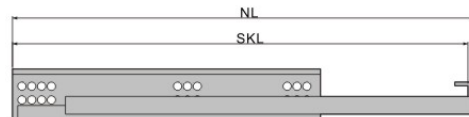
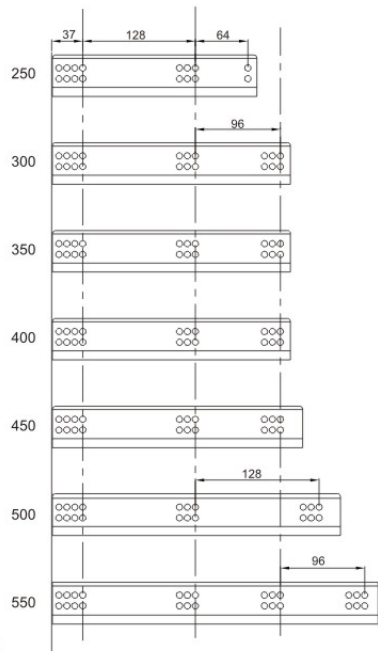

规格	10"	12"	14"	16"	18"	20"	22"
NL	250	300	350	400	450	500	550
SKL	250	300	350	400	450	500	550

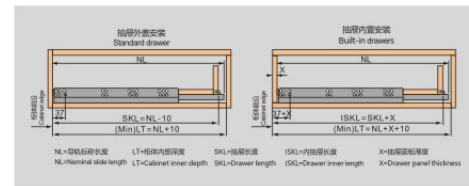
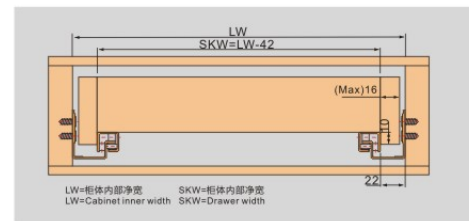

产品描述/Description

二节阻尼隐藏滑轨 带把手
3/4 extension soft closing concealed slide with handles

隐藏式全拉出缓冲导轨
动态负载: 30kg(18")
材质: 镀锌钢板
材料厚度(上/中/下轨):1.0x1.5x1.8mm
带快速折装扣手, 抽屉可快速安装和拆卸
抽屉面板高度间隙可调1-3mm

Three-fold soft close concealed slide
Loading capacity: 30kg(18")
Material: Galvanized sheet
Thickness of Material(1.0/1.5/1.8mm)
Tool-free quick Installation
Drawer height adjustable by 1-3mm

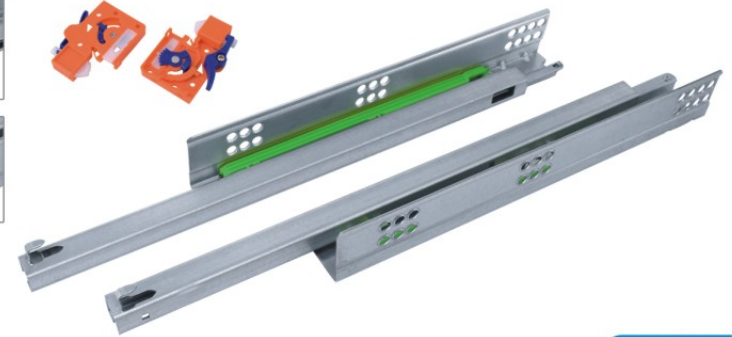
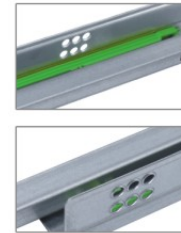

03613

侧轨安装孔位置Side rail mounting hole location

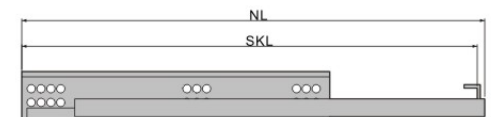
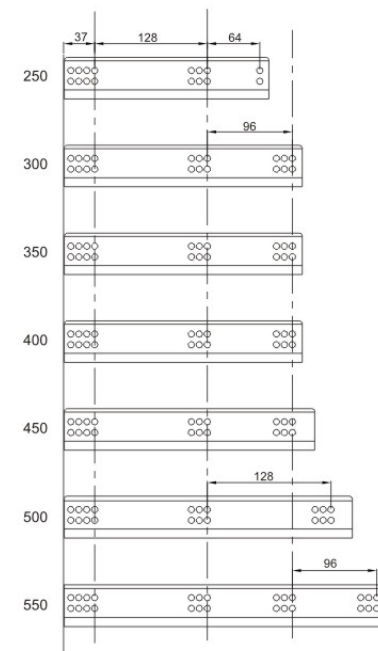

规格	10"	12"	14"	16"	18"	20"	22"
NL	250	300	350	400	450	500	550
SKL	250	300	350	400	450	500	550

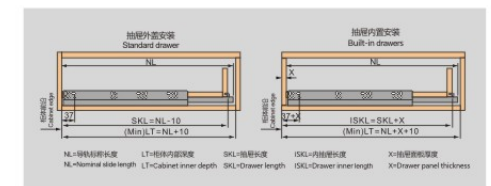
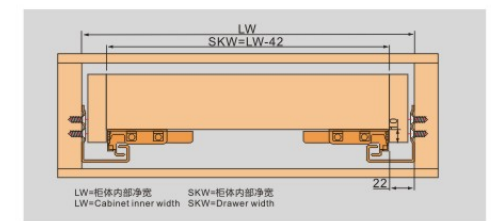



产品描述/Description
三节阻尼隐藏滑轨 带销钉
 Full extension soft closing concealed slide with pin fixing

隐藏式全拉出缓冲导轨
 动态负载: 30kg(18")
 材质: 镀锌钢板
 材料厚度(上/中/下轨):1.0x1.5x1.8mm
 带快速折装扣手, 抽屉可快速安装和拆卸
 抽屉面板高度间隙可调1-3mm

Three-fold soft close concealed slide
 Loading capacity: 30kg(18")
 Material: Galvanized sheet
 Thickness of Material(1.0/1.5/1.8mm)
 Tool-free quick installation
 Drawer height adjustable by 1-3mm



03610

侧轨安装孔位置Side rail mounting hole location

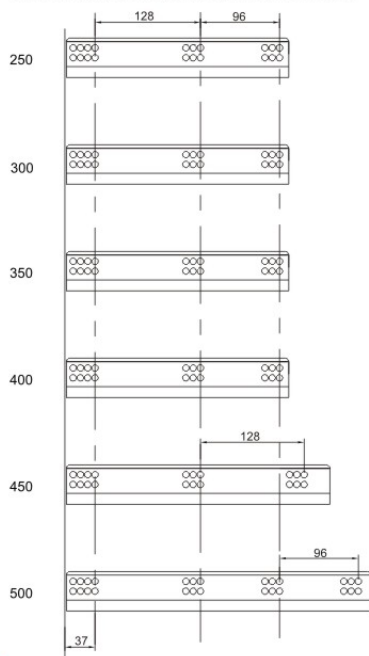

	NL						
	SKL						
规格	10"	12"	14"	16"	18"	20"	22"
NL	250	300	350	400	450	500	550
SKL	250	300	350	400	450	500	550

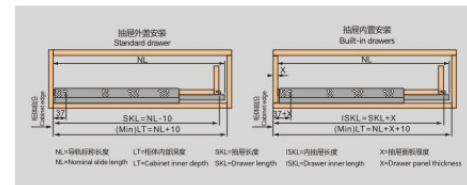
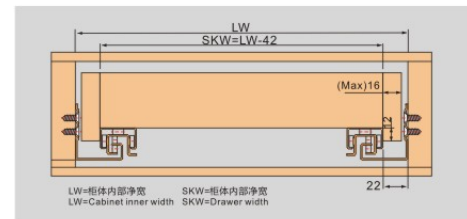

产品描述/Description
三节阻尼隐藏滑轨 带把手
 Full extension soft closing concealed slide with handles

隐藏式全拉出缓冲导轨
 动态负载: 30kg(18")
 材质: 镀锌钢板
 材料厚度(上/中/下轨):1.0x1.5x1.8mm
 带快速折装扣手, 抽屉可快速安装和拆卸
 抽屉面板高度间隙可调1-3mm

Three-fold soft close concealed slide
 Loading capacity: 30kg(18")
 Material: Galvanized sheet
 Thickness of Material(1.0/1.5/1.8mm)
 Tool-free quick installation
 Drawer height adjustable by 1-3mm



03608

侧轨安装孔位置Side rail mounting hole location

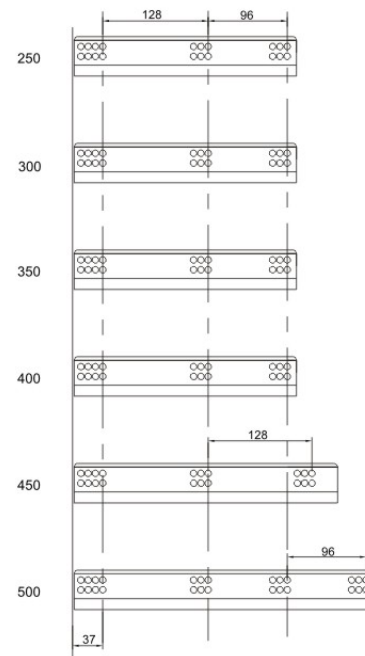

	NL						
	SKL						
规格	10"	12"	14"	16"	18"	20"	22"
NL	250	300	350	400	450	500	550
SKL	250	300	350	400	450	500	550

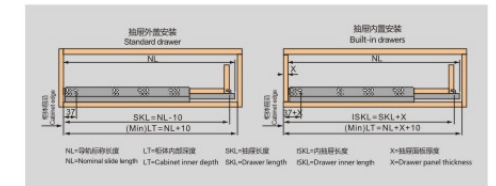
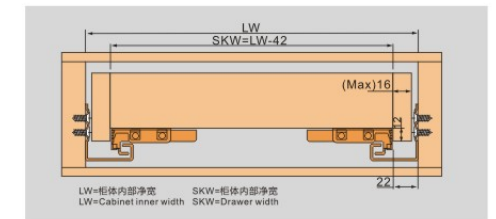



产品描述/Description
三节阻尼隐藏美式滑轨 带把手
 Full extension soft closing concealed slide with handles - American type

隐藏式全拉出缓冲导轨
 动态负载: 30kg(18")
 材质: 镀锌钢板
 材料厚度(上/中/下轨):1.0x1.5x1.8mm
 带快速折装扣手, 抽屈可快速安装和拆卸
 抽屈面板高度间隙可调1-3mm

Three-fold soft close concealed slide
 Loading capacity: 30kg(18")
 Material: Galvanized sheet
 Thickness of Material(1.0/1.5/1.8mm)
 Tool-free quick Installation
 Drawer height adjustable by 1-3mm



03619

侧轨安装孔位置Side rail mounting hole location

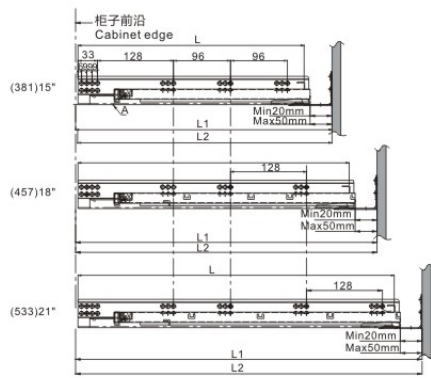

规格	15"	18"	21"
----	-----	-----	-----

适用于16mm以下抽屉侧板
 Suitable for 16mm drawer side panels

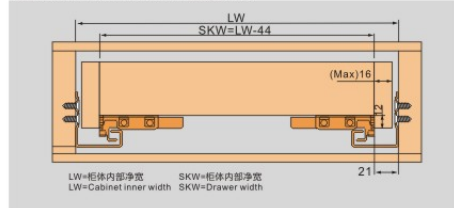

适用于18mm以下抽屉侧板
 Suitable for 18mm drawer side panels

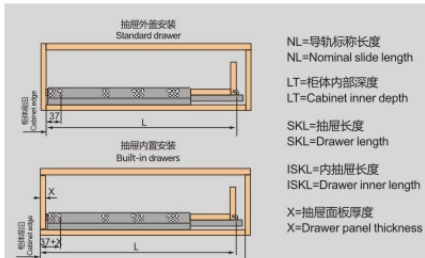
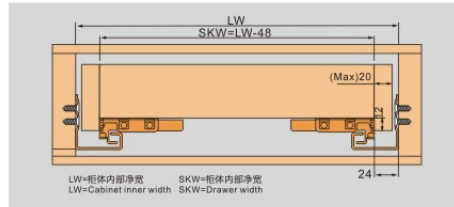

产品描述/Description
二节反弹隐藏滑轨 带销钉
 3/4 extension push-to-open concealed slide with pin fixing

隐藏式全拉出缓冲导轨
 动态负载: 30kg(18")
 材质: 镀锌钢板
 材料厚度(上/中/下轨):1.0x1.5x1.8mm
 带快速折装扣手, 抽屈可快速安装和拆卸
 抽屈面板高度间隙可调1-3mm

Three-fold soft close concealed slide
 Loading capacity: 30kg(18")
 Material: Galvanized sheet
 Thickness of Material(1.0/1.5/1.8mm)
 Tool-free quick Installation
 Drawer height adjustable by 1-3mm



03616

侧轨安装孔位置Side rail mounting hole location

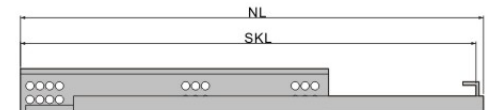
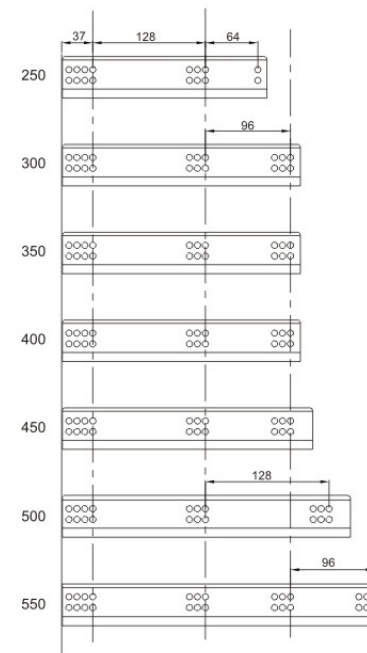

规格	10"	12"	14"	16"	18"	20"	22"
NL	250	300	350	400	450	500	550
SKL	250	300	350	400	450	500	550

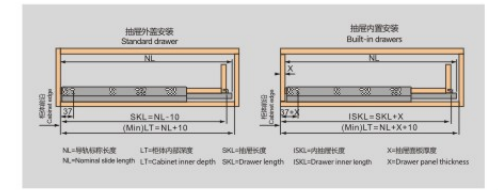
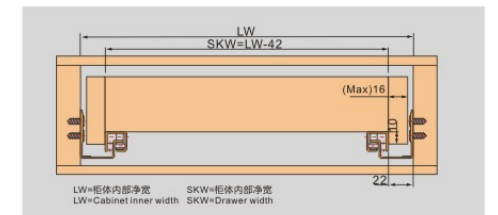

Drawer systems

- Sturdy ◦
- Smooth-running ◦
- Convenient ◦
- Attractive ◦



产品描述/Description

三节反弹隐藏滑轨 带把手
Full extension push-to-open concealed slide with handles

隐藏式全拉出缓冲导轨	Three-fold soft close concealed slide
动态负载: 30kg(18")	Loading capacity: 30kg(18")
材质: 镀锌钢板	Material: Galvanized sheet
材料厚度(上/中/下轨):1.0x1.5x1.8mm	Thickness of Material(1.0/1.5/1.8mm)
带快速拆装扣手, 抽屈可快速安装和拆卸	Tool-free quick Installation
抽屈面板高度间隙可调1-3mm	Drawer height adjustable by 1-3mm

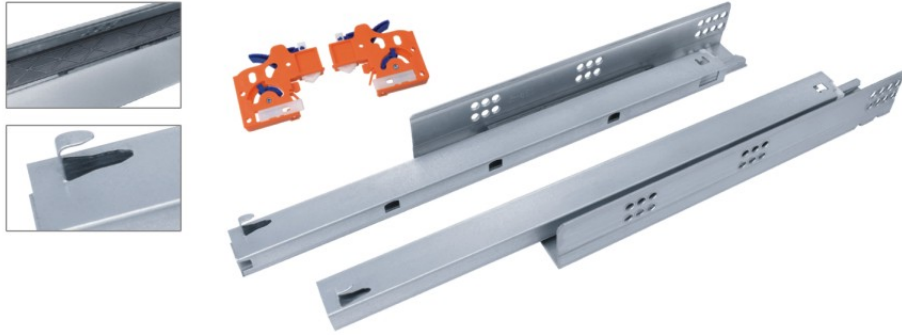

03611

侧轨安装孔位置 Side rail mounting hole location

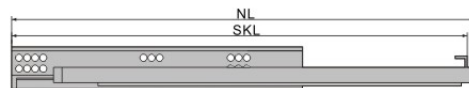
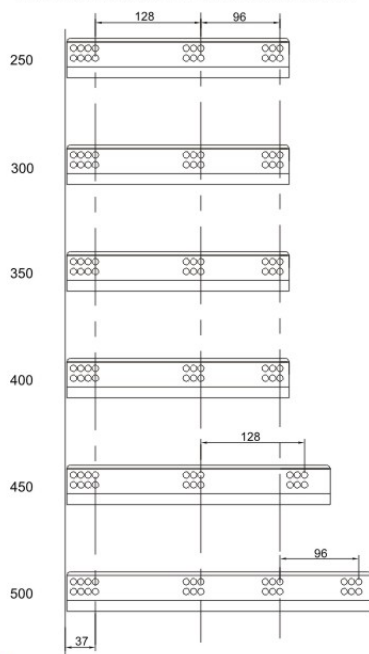

规格	10"	12"	14"	16"	18"	20"	22"
NL	250	300	350	400	450	500	550
SKL	250	300	350	400	450	500	550

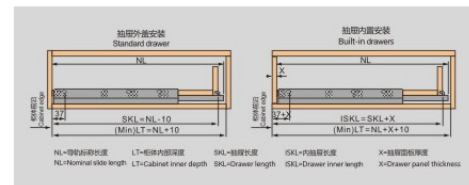
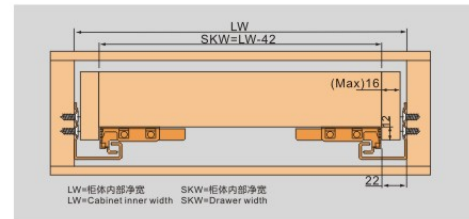



产品描述/Description

超薄款骑马抽屉(铁)
Soft closing slim tandem box kitchen drawer system - steel box

可承载负荷: 35公斤(450毫米标准长度) Loading capacity: 35kg(450mm as standard)
表面处理: 闪银灰色 Finish: Flash silver gray
主要材质: 镀锌板 Main material: Galvanized sheet
侧板高度86mm, 产品尺寸300-500mm也可根据要求定制。
86mm height of the side plate, Specific 300-500mm customized is available

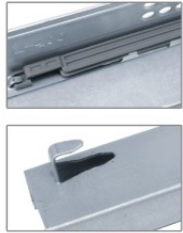

03621

the undermount slide installation hole system

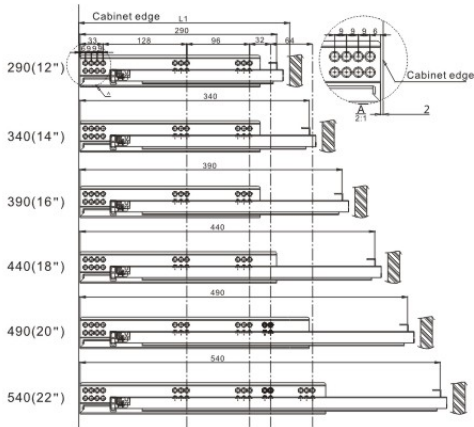

1) Please install the drawer and slide well, and keep the slide full extension outside the drawer.



2) The connecting link be installed on the bottom of the drawer.

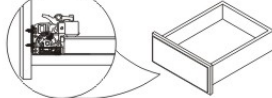

3) Please put the drawer flat on the slide, and close the drawer completely. When the slide be connected with connecting link, then the installation to be finished.

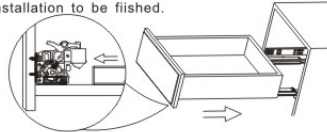

4) Press the connecting link then you can take out the drawer.

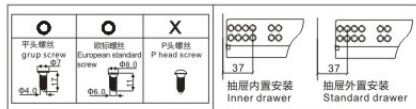
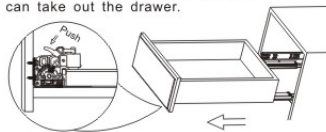

PLANNING DIMENSIONS

All dimensions in millimetres

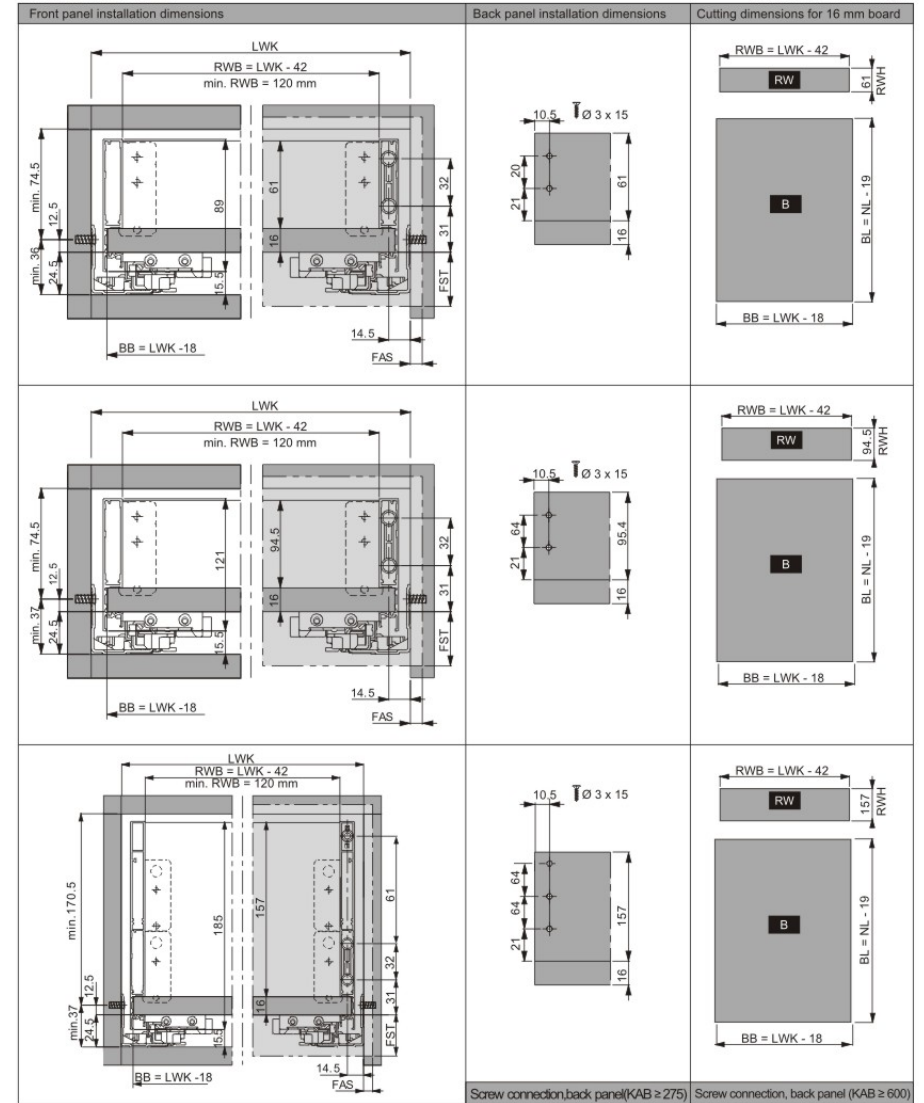

LEGEND

B	Bottom panel	FST	Front overlay	NL	Nominal length
BB	Bottom panel width	KV	Front edge of cabinet	RW	Back panel
BL	Bottom panel length	LWK	Inside cabinet width	RWB	Width of back panel
FAS	Front overlay, side	MET	Minimum installation depth	RWH	Height of back panel

All dimensions in millimetres. Subject to changes.



产品描述/Description
超薄款骑马抽屉(铝)
 Soft closing slim tandem box kitchen drawer system - aluminium box
 可承载负荷: 35公斤(450毫米标准长度) Loading capacity: 35kg(450mm as standard)
 表面处理: 闪银灰色,香槟金色,香槟粉色 Finish: Flash silver gray, Champagne Golden, Champagne pink
 主要材质: 镀锌板 Main material: Galvanized sheet
 侧板高度86mm, 产品尺寸300-500mm也可根据要求定制。
 86mm height of the side plate, Specific 300-500mm customized is available

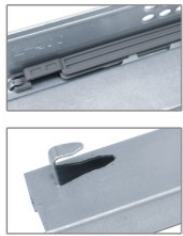

03622

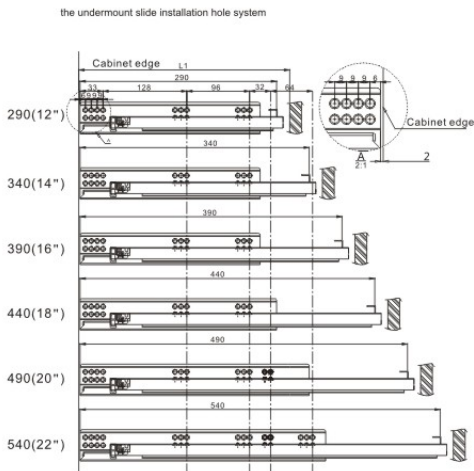

1) Please install the drawer and slide well, and keep the slide full extension outside the drawer.



2) The connecting link be installed on the bottom of the drawer.

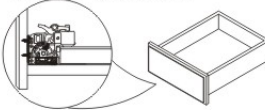

3) Please put the drawer flat on the slide, and close the drawer completely. When the slide be connected with connecting link, then the installation to be finished.

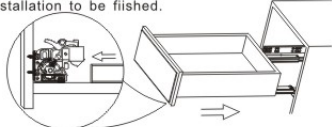

4) Press the connecting link then you can take out the drawer.

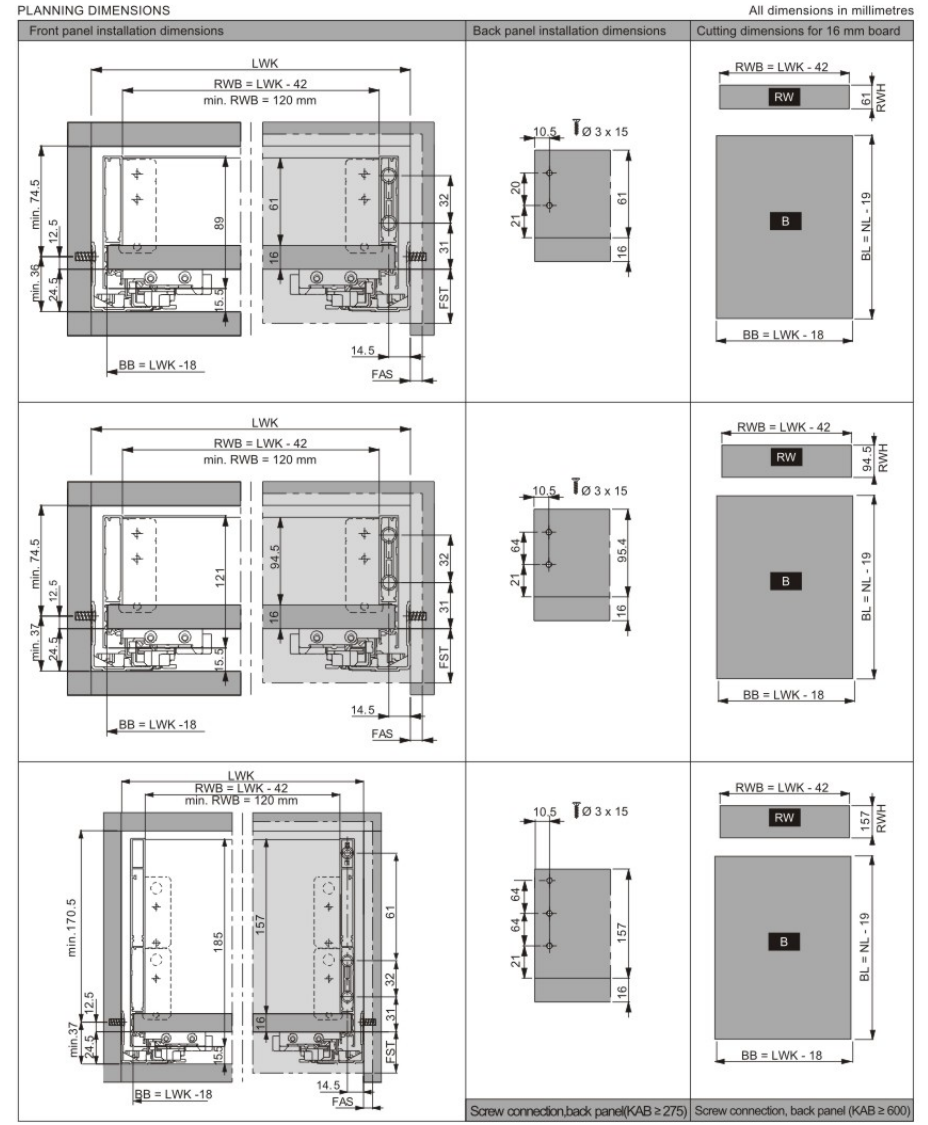
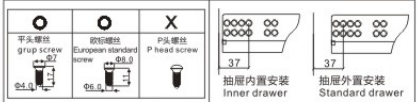
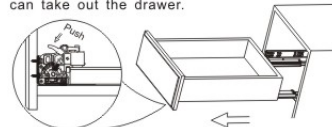

LEGEND

B	Bottom panel	FST	Front overlay	NL	Nominal length
BB	Bottom panel width	KV	Front edge of cabinet	RW	Back panel
BL	Bottom panel length	LWK	Inside cabinet width	RWB	Width of back panel
FAS	Front overlay, side	MET	Minimum installation depth	RWH	Height of back panel

All dimensions in millimetres. Subject to changes.



产品描述/Description

D款骑马抽屉
Soft closing tandem box kitchen drawer system - D type

可承载负荷: 35公斤(450毫米标准长度) Loading capacity: 35kg(450mm as standard)
表面处理: 闪银灰色 Finish: Flash silver gray
主要材质: 镀锌板 Main material: Galvanized sheet

侧板高度86mm, 产品尺寸300-500mm也可根据要求定制。
86mm height of the side plate, Specific 300-500mm customized is available



03604

抽屉安装示范 Drawaer Installation Instruction



中、高抽屉安装示范 Medium Drawaer & High Drawaer Installation Instruction

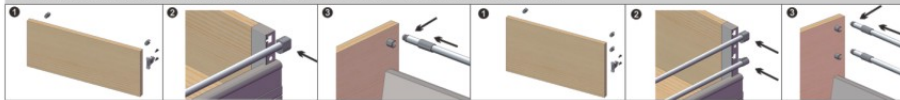

抽屉拆卸 Drawaer removal 面板调节与拆卸 Panel adjust and removal

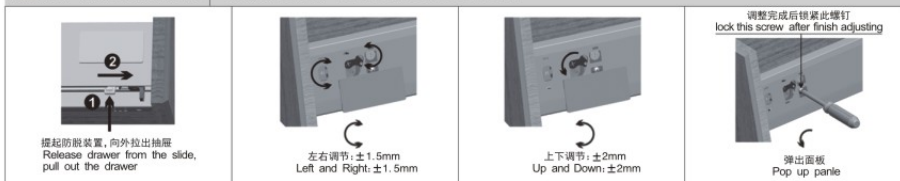

低抽屉: L高度(Low Drawer: L Height)			抽屉板裁切尺寸 Cutting dimensions for chipboard	
<p>柜体所需空间 (Space requirement in cabinet)</p>	<p>面板钻孔尺寸 (Front drilling dimensions)</p> <p>FA: 面板重叠距离 the distance of panel overlap</p>	<p>后背板安装尺寸 (Back installation dimensions)</p>	<p>低抽屉: L高度 (Low Drawer: L Height)</p> <p>LW=柜体内部宽度 (Internal cabinet Width) NL=滑轨标称长度 (Nominal Slide Length)</p>	
中抽屉: M高度(Medium Drawer: M Height)			中抽屉: M高度 (Medium Drawer: M Height) 高抽屉: H高度 (High Drawer: H Height)	
<p>柜体所需空间 (Space requirement in cabinet)</p>	<p>面板钻孔尺寸 (Front drilling dimensions)</p> <p>FA: 面板重叠距离 the distance of panel overlap</p>	<p>后背板安装尺寸 (Back installation dimensions)</p>	<p>后背板 Back (135, LW-87, 16)</p> <p>高抽屉: H高度 (High Drawer: H Height) 后背板 Back (199, LW-87, 16)</p> <p>底板 Bottom (NL-24, LW-75)</p> <p>高抽屉: H高度 (High Drawer: H Height) 底板 Bottom (NL-24, LW-75)</p> <p>LW=柜体内部宽度 (Internal cabinet Width) NL=滑轨标称长度 (Nominal Slide Length)</p>	
高抽屉: H高度(High Drawer: H Height)			滑轨安装孔尺寸 Screw Positions of the Slide	
<p>柜体所需空间 (Space requirement in cabinet)</p>	<p>面板钻孔尺寸 (Front drilling dimensions)</p> <p>FA: 面板重叠距离 the distance of panel overlap</p>	<p>后背板安装尺寸 (Back installation dimensions)</p>	<p>柜体前缘 Cabinet edge</p>	
滑轨安装尺寸 Installation dimensions				



产品描述/Description

B款骑马抽屉
Soft closing tandem box kitchen drawer system - B type

可承载负荷: 35公斤(450毫米标准长度) Loading capacity: 35kg(450mm as standard)
表面处理: 闪银灰色 Finish: Flash silver gray
主要材质: 镀锌板 Main material: Galvanized sheet

侧板高度86mm, 产品尺寸300-500mm也可根据要求定制。
86mm height of the side plate, Specific 300-500mm customized is available



03603

抽屉安装示范 Drawaer Installation Instruction



中、高抽屉安装示范 Medium Drawaer & High Drawaer Installation Instruction

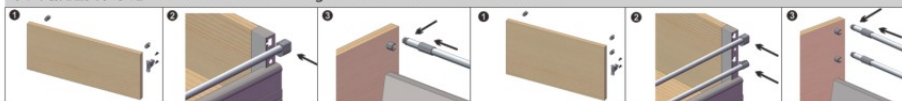

抽屉拆卸 Drawaer removal 面板调节与拆卸 Panel adjust and removal

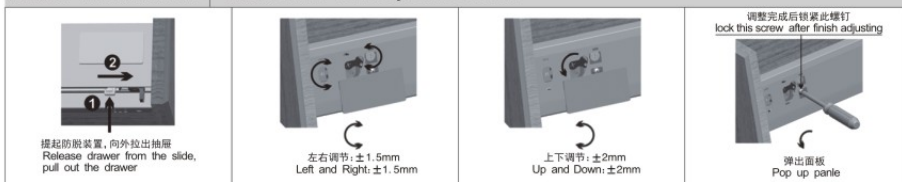

低抽屉: L高度(Low Drawer: L Height)			抽屉板裁切尺寸 Cutting dimensions for chipboard	
柜体所需空间 (Space requirement in cabinet)	面板钻孔尺寸 (Front drilling dimensions)	后背板安装尺寸 (Back installation dimensions)	W=柜体内部宽度(Internal cabinet Width) NL=滑轨标称长度(Nominal Slide Length)	
			低抽屉: L高度 (Low Drawer: L Height)	
中抽屉: M高度(Medium Drawer: M Height)			中抽屉: M高度 (Medium Drawer: M Height)	
柜体所需空间 (Space requirement in cabinet)	面板钻孔尺寸 (Front drilling dimensions)	后背板安装尺寸 (Back installation dimensions)		
			后挡板 Back	
高抽屉: H高度(High Drawer: H Height)			高抽屉: H高度 (High Drawer: H Height)	
柜体所需空间 (Space requirement in cabinet)	面板钻孔尺寸 (Front drilling dimensions)	后背板安装尺寸 (Back installation dimensions)		
			后挡板 Back	
滑轨安装尺寸 Installation dimensions			滑轨安装孔尺寸 Screw Positions of the Slide	

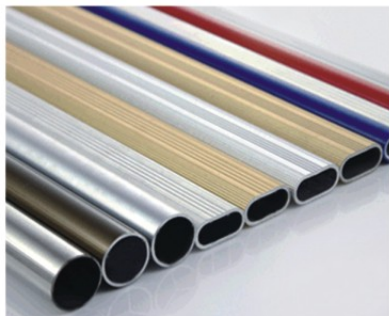

Description

产品描述

主要材质: 铁、锌合金
表面处理: 镀铬

Main material: Steel/ zinc alloy
Finish: Chrome plated



Description

产品描述

主要材质: 铁、锌合金
表面处理: 镀铬

Main material: Steel/ zinc alloy
Finish: Chrome plated



8"/200mm
10"/250mm

05001

φ25衣通管/φ25mm Wardrobe tube



8"/200mm
10"/250mm

05002

15×30椭圆管/Oval tube 15×30mm



8"/200mm
10"/250mm

05003

φ16管/φ16mm Tube



φxH
25x15

05101

φ25法兰/φ25mm Flange



φxH
16x15

05102

φ16法兰/φ16mm Flange



φxH
50x15

05103

φ50法兰/φ50mm Flange



8"/200mm
10"/250mm

05004

φ50管/φ50mm Tube



8"/200mm
10"/250mm

05005

φ19管/φ19mm Tube



8"/200mm
10"/250mm

05006

φ32管/φ32mm Tube



05104

锌合金衣通托
Zamac wardrobe tube support



05105

合金斜边衣通托
Zamac wardrobe tube support



05210

锌合金衣通托
Zamac wardrobe tube support



8"/200mm
10"/250mm

05007

φ10管/φ10mm Tube



8"/200mm
10"/250mm

05008

25×25方管/Square tube 25×25mm





产品描述/Description

套筒气杆支撑/Sleeve barrel gas spring

支撑力: 50N-150N	Force:50N-150N
中心距: 248毫米	Center: 248mm
行程: 90毫米	Stroke: 90mm
杆表面处理: 镀硬铬	Finish: Ridgid chrome plated
管表面处理: 镀铬、喷漆	Finish: Chrome plated spray-paint
主要材质: 铁、铜	Main material: Steel/ copper
包装数量: 100支/箱	Packing: 100psc/CTN

可选功能: 上翻门支撑、下翻门缓冲、上翻门任意停、上翻门缓冲
Funtion: support/up/down/free stop/double step close



09111

Model 产品型号	Status 状态											
	80°				90°				110°			
门板高度(mm) Door height	300	400	500	600	300	400	500	600	300	400	500	600
80N	≤2.6	≤2.2	≤1.7	≤1.3	≤2.4	≤2.0	≤1.6	≤1.2	≤2.1	≤1.7	≤1.4	≤1.0
100N	≤3.3	≤2.7	≤2.2	≤1.6	≤3	≤2.5	≤2.0	≤1.5	≤2.6	≤2.2	≤1.7	≤1.3
120N	≤4	≤3.3	≤2.6	≤2	≤3.6	≤3.0	≤2.4	≤1.8	≤3.2	≤2.6	≤2.1	≤1.6

产品用途: 液压下翻支撑
用途说明: 可使下翻木门、铝框门稳定速度缓慢向下翻。

Usage: Hydraulic next trun support the
Application: Can the next turn wooden/aluminum door frame slow steady downward turn.

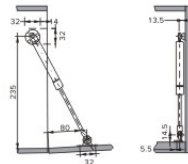

可选配件
Optional Fitting

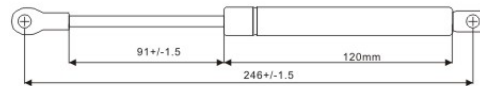

产品描述/Description

快装气杆支撑/Fast-assembling gas spring

支撑力: 50N-150N	Force:50N-150N
中心距: 248毫米	Center: 248mm
行程: 90毫米	Stroke: 90mm
杆表面处理: 镀硬铬	Finish: Ridgid chrome plated
管表面处理: 镀铬、喷漆	Finish: Chrome plated spray-paint
主要材质: 铁、铜	Main material: Steel/ copper
包装数量: 100支/箱	Packing: 100psc/CTN

可选功能: 上翻门支撑、下翻门缓冲、上翻门任意停、上翻门缓冲
Funtion: support/up/down/free stop/double step close



09110

Model 产品型号	Status 状态											
	80°				90°				110°			
门板高度(mm) Door height	300	400	500	600	300	400	500	600	300	400	500	600
80N	≤2.6	≤2.2	≤1.7	≤1.3	≤2.4	≤2.0	≤1.6	≤1.2	≤2.1	≤1.7	≤1.4	≤1.0
100N	≤3.3	≤2.7	≤2.2	≤1.6	≤3	≤2.5	≤2.0	≤1.5	≤2.6	≤2.2	≤1.7	≤1.3
120N	≤4	≤3.3	≤2.6	≤2	≤3.6	≤3.0	≤2.4	≤1.8	≤3.2	≤2.6	≤2.1	≤1.6

产品用途: 液压下翻支撑
用途说明: 可使下翻木门、铝框门稳定速度缓慢向下翻。

Usage: Hydraulic next trun support the
Application: Can the next turn wooden/aluminum door frame slow steady downward turn.

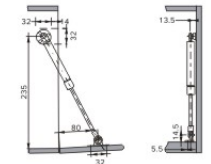

可选配件
Optional Fitting

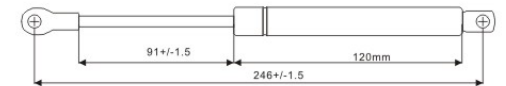



产品描述/Description

气杆支撑/Gas spring

支撑力: 50N-150N	Force:50N-150N
中心距: 248毫米	Center: 248mm
行程: 90毫米	Stroke: 90mm
杆表面处理: 镀硬铬	Finish: Ridgid chrome plated
管表面处理: 镀铬、喷漆	Finish: Chrome plated spray-paint
主要材质: 铁、铜	Main material: Steel/ copper
包装数量: 100支/箱	Packing: 100psc/CTN

可选功能: 上翻门支撑、下翻门缓冲、上翻门任意停、上翻门缓冲
Funtion: support/up/down/free stop/double step close



09101

Model 产品型号	Status 状态											
	80°				90°				110°			
门板高度(mm) Door height	300	400	500	600	300	400	500	600	300	400	500	600
80N	≤2.6	≤2.2	≤1.7	≤1.3	≤2.4	≤2.0	≤1.6	≤1.2	≤2.1	≤1.7	≤1.4	≤1.0
100N	≤3.3	≤2.7	≤2.2	≤1.6	≤3	≤2.5	≤2.0	≤1.5	≤2.6	≤2.2	≤1.7	≤1.3
120N	≤4	≤3.3	≤2.6	≤2	≤3.6	≤3.0	≤2.4	≤1.8	≤3.2	≤2.6	≤2.1	≤1.6

产品用途: 液压下翻支撑
用途说明: 可使下翻木门、铝框门稳定速度缓慢向下翻。

Usage: Hydraulic next trun support the
Application: Can the next turn wooden/aluminum door frame slow steady downward turn.

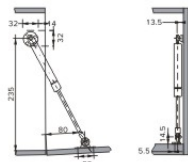

可选配件
Optional Fitting



长孔铝门配件
Long-Hole Aluminium
Frame Fitting



圆孔铝门配件
Circular-Hole Aluminium
Frame Fitting



木牙螺丝
Chipboard Screw

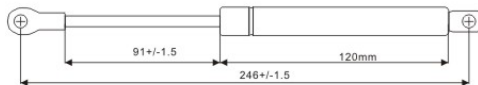

产品描述/Description

短臂气杆支撑/Short arm gas spring

支撑力: 50N-150N	Force:50N-150N
中心距: 248毫米	Center: 248mm
行程: 90毫米	Stroke: 90mm
杆表面处理: 镀硬铬	Finish: Ridgid chrome plated
管表面处理: 镀铬、喷漆	Finish: Chrome plated spray-paint
主要材质: 铁、铜	Main material: Steel/ copper
包装数量: 100支/箱	Packing: 100psc/CTN

可选功能: 上翻门支撑、下翻门缓冲、上翻门任意停、上翻门缓冲
Funtion: support/up/down/free stop/double step close



09103

Model 产品型号	Status 状态											
	80°				90°				110°			
门板高度(mm) Door height	300	400	500	600	300	400	500	600	300	400	500	600
80N	≤2.6	≤2.2	≤1.7	≤1.3	≤2.4	≤2.0	≤1.6	≤1.2	≤2.1	≤1.7	≤1.4	≤1.0
100N	≤3.3	≤2.7	≤2.2	≤1.6	≤3	≤2.5	≤2.0	≤1.5	≤2.6	≤2.2	≤1.7	≤1.3
120N	≤4	≤3.3	≤2.6	≤2	≤3.6	≤3.0	≤2.4	≤1.8	≤3.2	≤2.6	≤2.1	≤1.6

产品用途: 液压下翻支撑
用途说明: 可使下翻木门、铝框门稳定速度缓慢向下翻。

Usage: Hydraulic next trun support the
Application: Can the next turn wooden/aluminum door frame slow steady downward turn.

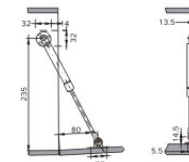

可选配件
Optional Fitting



长孔铝门配件
Long-Hole Aluminium
Frame Fitting



圆孔铝门配件
Circular-Hole Aluminium
Frame Fitting



木牙螺丝
Chipboard Screw

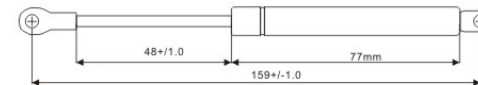



产品描述/Description

扁头气杆支撑/Gas spring square plate head

支撑力: 50N-150N	Force: 50N-150N
行程: 90毫米	Stroke: 90mm
杆表面处理: 镀硬铬	Finish: Rigid chrome plated
管表面处理: 镀铬、喷漆	Finish: Chrome plated spray-paint
主要材质: 铁、铜	Main material: Steel/ copper

可选功能: 上翻门支撑、下翻门缓冲、上翻门任意停、上翻门缓冲
Function: support/up/down/free stop/double step close



09104

Model 产品型号	门板重量(kg) Door weight	80°				90°				110°			
		300	400	500	600	300	400	500	600	300	400	500	600
80N	≤2.6	≤2.2	≤1.7	≤1.3	≤2.4	≤2.0	≤1.6	≤1.2	≤2.1	≤1.7	≤1.4	≤1.0	
100N	≤3.3	≤2.7	≤2.2	≤1.6	≤3	≤2.5	≤2.0	≤1.5	≤2.6	≤2.2	≤1.7	≤1.3	
120N	≤4	≤3.3	≤2.6	≤2	≤3.6	≤3.0	≤2.4	≤1.8	≤3.2	≤2.6	≤2.1	≤1.6	

产品用途: 液压下翻支撑
用途说明: 可使下翻木门、铝框门稳定速度缓慢向下翻。

Usage: Hydraulic next turn support the
Application: Can the next turn wooden/aluminum door frame slow steady downward turn.

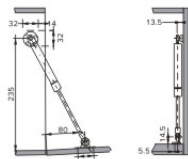

可选配件
Optional Fitting

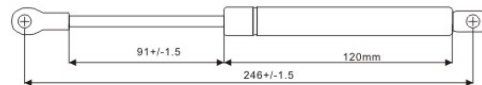

产品描述/Description

油压支撑/Oil braking lid stay

支撑力: 50N-150N	Force: 50N-150N
行程: 90毫米	Stroke: 90mm
杆表面处理: 镀硬铬	Finish: Rigid chrome plated
管表面处理: 镀铬、喷漆	Finish: Chrome plated spray-paint
主要材质: 铁、铜	Main material: Steel/ copper

可选功能: 上翻门支撑、下翻门缓冲、上翻门任意停、上翻门缓冲
Function: support/up/down/free stop/double step close

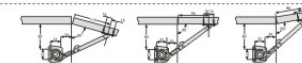

09105

Model 产品型号	门板重量(kg) Door weight	80°				90°				110°			
		300	400	500	600	300	400	500	600	300	400	500	600
80N	≤2.6	≤2.2	≤1.7	≤1.3	≤2.4	≤2.0	≤1.6	≤1.2	≤2.1	≤1.7	≤1.4	≤1.0	
100N	≤3.3	≤2.7	≤2.2	≤1.6	≤3	≤2.5	≤2.0	≤1.5	≤2.6	≤2.2	≤1.7	≤1.3	
120N	≤4	≤3.3	≤2.6	≤2	≤3.6	≤3.0	≤2.4	≤1.8	≤3.2	≤2.6	≤2.1	≤1.6	

产品用途: 可折合数千次, 而力度不变。
用途说明: 可多种安装类型效果

Usage: Several thousand cycles and same force
Application: Many kinds of assemble type

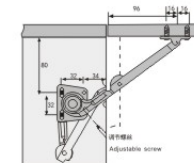



产品描述/Description

弧形臂支撑/Arc zamac lid stay

可承载负荷: 3-5公斤
主要材质: 锌合金
表面处理: 镀金, 珍珠铬, 镀镍
边框宽度: 木框门20mm, 铝框门45mm
支撑臂与安装片固定方式: 快装卡入式

Loading rate: 3-5kg
Material: zinc alloy
Finish: Gold / pearl chrome / nickel
Border width: Wood frame door 20mm
aluminum frame doors 45
Support arm and the installation is fixed by quick snap

应用范围: 适用于木质及铝框上翻门, 也可用于木质下翻门。
功能: 任意停位, 具有自动闭合功能的75°, 90°, 110°

Applications: Suitable for turning wood and aluminum frame doors can also be used under the turned wood door
Function: Any stop bits, with automatic closing feature 75° / 90° / 110°

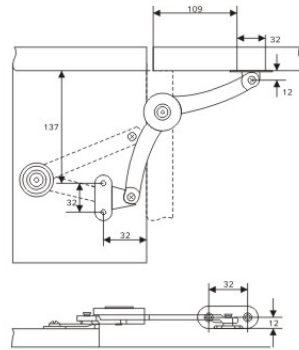

09106

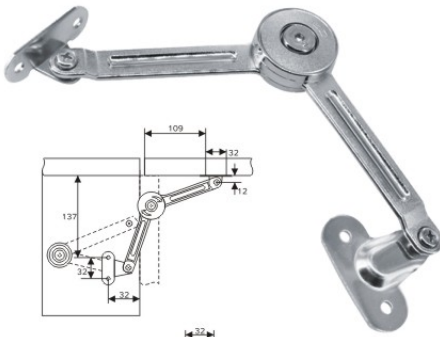

09107

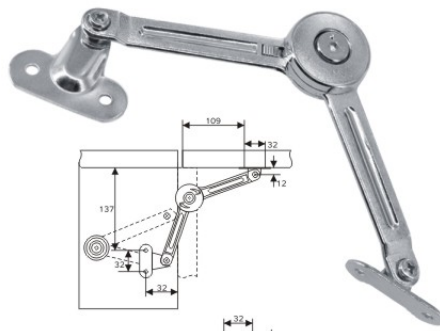

09108



产品描述/Description

吊码系列/hanging series



A 小钩
Small hook



B 小钩
Big hook

承重力更强, 轻松调节, 方便快速安装。
Best load-bearing, easily adjust, convenient for quick installation.

10104 超薄型合金吊码
Thin zinc alloy cabinet hanger w/cover

材质: 锌合金+塑料
表面处理: 白色、灰色
最大承重: 550N/pc
Material: Zinc alloy+Plastic
Finish: White/Gray
Loading capacity: 550N/pc



10101 普通吊码
Cabinet hanger

材质: 塑料+铁
表面处理: 白色、灰色
最大承重: 550N/pc
Material: Plastic+iron
Finish: White/Gray
Loading capacity: 550N/pc



10102 驼背吊码
Curve top cabinet hanger

材质: 塑料+铁
表面处理: 白色、灰色
最大承重: 550N/pc
Material: Plastic+iron
Finish: White/Gray
Loading capacity: 550N/pc



10105 超薄型吊码
Thin cabinet hanger with cover

材质: 塑料+铁
表面处理: 白色、灰色
最大承重: 550N/pc
Material: Plastic+iron
Finish: White/Gray
Loading capacity: 550N/pc



10301 双向挂片
Two direction cabinet hanging plate



材质: 铁
Material: Iron

10901 单向挂片
One direction cabinet hanging plate



材质: 铁
Material: Iron

10903 挂轨
Long cabinet hanging plate



材质: 铁
Material: Iron