



JD-1043



JD-1044



JD-1045A



JD-1045W



JD-1046



# LED Garden Light JD-1043/1044/ 1045A/1045W/ 1046





CE CB

# JD-1043B Korea led Modules



# Led Street Light JD-1043A



## 5050/3030 led, 130-140lm/w Meanwell/Philips/Osram driver

- Modern fashion design of appearance, made the light become an artwork, Integrated with the environment perfectly, to made is as top project.
- Used in high strength aluminum die casting material, surface anit-ageing electrostatic spray processing, super resistance to corrosion.
- High transparent tempered glass cover, high strength impact resistance.
- Input Voltage: AC110-277V, 50/60Hz, IP66, Ik09
- Horizontal version angle adjustable : +15° ~ -15°
- Vertical version andle adjustable : +15° ~ -15°

- Different type lens for choice
- Windy area : 570 cm<sup>2</sup>
- Spare parts for choice
- 10 kv/20kv SPD
- 0-10v dimming driver
- auto switch
- Nema socket
- 5 years warranty

### 技术参数 Specification

产品型号	Product Code	JD-1043A-30W	JD-1043A-60W	JD-1043A-100W
led 电流 ( mA)	LED Current (mA)	50mA 5050/67mA 3030	54mA 5050/67mA 3030	63mA 5050/84mA 3030
LED数量	LED Quantity	24pcs 5050/72pcs 3030	48pcs 5050/144pcs 3030	64pcs 5050/192pcs 3030
额定功率	Rate Power	30W	60W	100W
色温	Color Temperature	6500/4000/3000K	6500/4000/3000K	6500/4000/3000K
灯具光效	Luminary EER	150lm/w(5050) 140lm/w(3030)	150lm/w(5050) 140lm/w(3030)	150lm/w(5050) 140lm/w(3030)
输入电压	Input Voltage	AC100-277V	AC100-277V	AC100-277V
频率	Frequency Range	50/60Hz	50/60Hz	50/60Hz
显色指数	CRI	Ra75	Ra75	Ra75
工作环境温度	Temperature of working condition	-40°C-50°C	-40°C-50°C	-40°C-50°C
工作环境湿度	humidity of working condition	20%-90%	20%-90%	20%-90%
LED 寿命	LED life time	100000h(L70)	100000h(L70)	100000h(L70)
防护等级	Protection Grade	IP66	IP66	IP66
安装管径	Installation Pipe Dia	Φ60mm	Φ60mm	Φ60mm
安装高度	Installation Height	4-6m	6-8m	8-10m
净重	Net Weight	7.35kgs	7.82kgs	8.2kgs
毛重	Gross Weight	8.53kgs	9.02kgs	9.4kgs
产品尺寸	Product Size	743*516*122mm	743*516*122mm	743*516*122mm
包装尺寸	Packing Size	655*590*165mm	655*590*165mm	655*590*165mm

注：包装尺寸为外尺寸  
本表所示技术参数均在环境温度为25°C，湿度35%的实验室环境中测得。

Packing size is outer size of box  
All parameters are measured at 25°C ambient temperature, 35% humidity experimental environment.

### 产品尺寸 Product Dimension

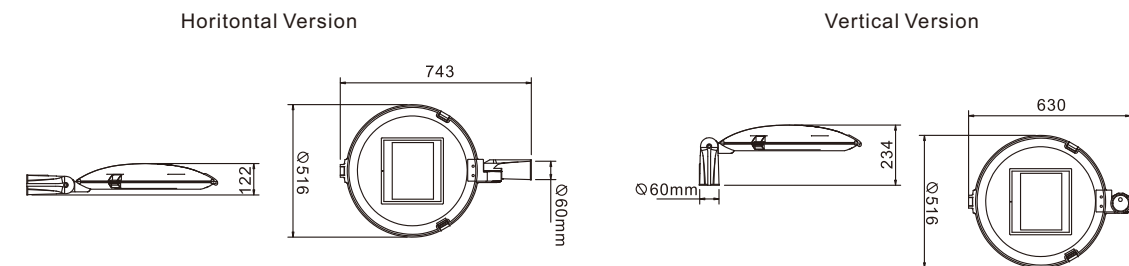

### 配光曲线图 Light Distribution Curve

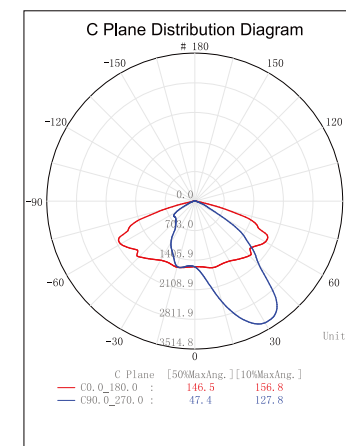

70W

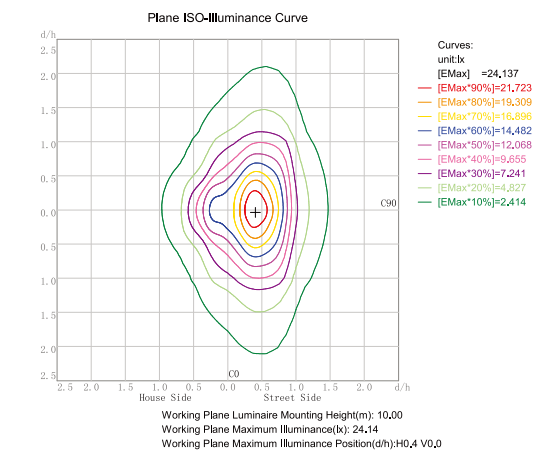

AC100-277V 输入电压 Input Voltage	Hz 50/60 频率范围 Frequency Range	PF >0.92 功率因数 Power Factor	<15% 总谐波失真 THD	CRI 75 显示指数 Color Rendering Index	-40~50 工作环境温度 Temperature of Working Condition	20~90% 工作环境湿度 Humidity of Working Condition	70000h 使用寿命 Life Time	IP66 防护等级 Protection Grade
-------------------------------------	--	-------------------------------------	----------------------	--	--	---	-----------------------------	----------------------------------





CE CB

# Led Garden Light JD-1044A



korea led modules

## 5050/3030 led, 130-140lm/w Meanwell/Philips/Osram driver

- Used in high strength aluminum die casting material, surface anit-ageing electrostatic spray processing, super resistance to corrosion.
- High transparent tempered glass cover, high strength impact resistance.
- Input Voltage: AC100-240V, 50/60Hz, IP66, Ik09
- Different type lens for choice
- Windy area : 815 cm<sup>2</sup>
- Spare parts for choice
- 10 kv/20kv SPD
- 0-10v dimming driver
- auto switch
- 5 years warranty

### 技术参数 Specification

产品型号	Product Code	JD-1044A-30W	JD-1044A-60W	JD-1044A-100W
led 电流 (mA)	LED Current (mA)	50mA 5050/67mA 3030	54mA 5050/67mA 3030	63mA 5050/84mA 3030
LED数量	LED Quantity	24pcs 5050/72pcs 3030	48pcs 5050/144pcs 3030	64pcs 5050/192pcs 3030
额定功率	Rate Power	30W	60W	100W
色温	Color Temperature	6500/4000/3000K	6500/4000/3000K	6500/4000/3000K
灯具光效	Luminary EER	140lm/w(5050) 130lm/w(3030)	140lm/w(5050) 130lm/w(3030)	140lm/w(5050) 130lm/w(3030)
输入电压	Input Voltage	AC100-277V	AC100-277V	AC100-277V
频率	Frequency Range	50/60Hz	50/60Hz	50/60Hz
显色指数	CRI	Ra75	Ra75	Ra75
工作环境温度	Temperature of working condition	-40°C-50°C	-40°C-50°C	-40°C-50°C
工作环境湿度	humidity of working condition	20%-90%	20%-90%	20%-90%
LED 寿命	LED life time	100000h(L70)	100000h(L70)	100000h(L70)
防护等级	Protection Grade	IP66	IP66	IP66
安装管径	Installation Pipe Dia	Φ76mm/Φ60mm	Φ76mm/Φ60mm	Φ76mm/Φ60mm
安装高度	Installation Height	4-6m	6-8m	8-10m
净重	Net Weight	7.9kgs	8.46kgs	8.9kgs
毛重	Gross Weight	9.1kgs	9.66kgs	10kgs
产品尺寸	Product Size	550*516*500mm	550*516*500mm	550*516*500mm
包装尺寸	Packing Size	655*590*165mm	655*590*165mm	655*590*165mm

注：包装尺寸为外尺寸  
本表所示技术参数均在环境温度为25°C，湿度35%的实验室环境中测得。

Packing size is outer size of box  
All parameters are measured at 25°C ambient temperature, 35% humidity experimental environment.

### 产品尺寸 Product Dimension

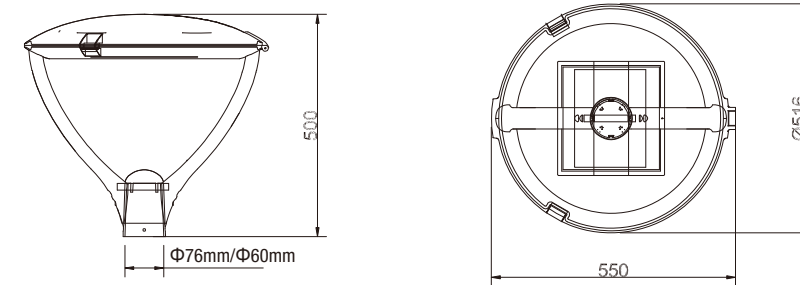

### 配光曲线图 Light Distribution Curve

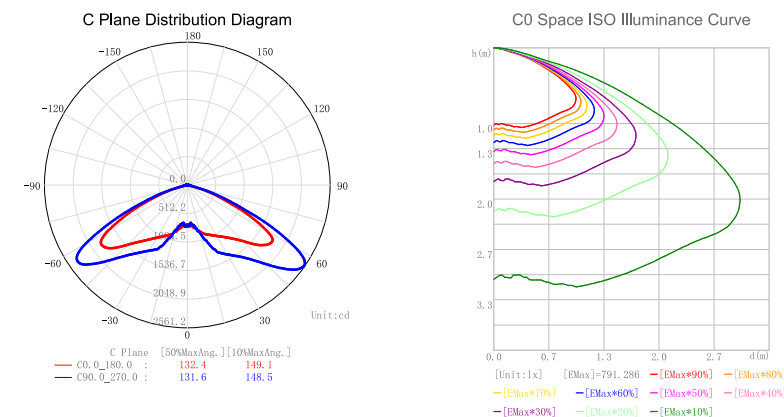

AC100-277V 输入电压 Input Voltage	Hz 50/60 频率范围 Frequency Range	PF >0.92 功率因数 Power Factor	<15% 总谐波失真 THD	CRI 75 显示指数 Color Rendering Index	-40~50°C 工作环境温度 Temperature of Working Condition	20~90% 工作环境湿度 Humidity of Working Condition	70000h 使用寿命 Life Time	IP66 防护等级 Protection Grade
-------------------------------------	--	-------------------------------------	----------------------	--	--	---	-----------------------------	----------------------------------



CE CB



技术参数 Specification

产品型号	Product Code	JD-1045A/JD-1045W 30W	JD-1045A/JD-1045W 60W	JD-1045A/JD-1045W 100W
灯珠电流	LED Current (mA)	50mA 5050/67mA 3030	54mA 5050/67mA 3030	63mA 5050/84mA 3030
LED数量	LED Quantity	24pcs 5050/72pcs 3030	48pcs 5050/144pcs 3030	64pcs 5050/192pcs 3030
额定功率	Rate Power	30W	60W	30W
色温	Color Temperature	6500/4000/3000K	6500/4000/3000K	6500/4000/3000K
灯具光效	Luminary EER	150lm/w(5050) 140lm/w(3030)	150lm/w(5050) 140lm/w(3030)	150lm/w(5050) 140lm/w(3030)
输入电压	Input Voltage	AC100-277V	AC100-277V	AC100-277V
频率	Frequency Range	50/60Hz	50/60Hz	50/60Hz
显色指数	CRI	RA75	RA75	RA75
工作环境温度	Temperature of working condition	-40℃-50℃	-40℃-50℃	-40℃-50℃
工作环境湿度	humidity of working condition	20%-90%	20%-90%	20%-90%
LED 寿命	LED life time	100000h(L70)	100000h(L70)	100000h(L70)
防护等级	Protection Grade	IP66	IP66	IP66
安装管径	Installation Pipe Dia	Φ60mm	Φ60mm	Φ60mm
安装高度	Installation Height	4-6m	6-8m	8-10m
净重	Net Weight	7.35kgs	7.82kgs	8.2kgs
毛重	Gross Weight	8.53kgs	9.02kgs	9.4kgs
产品尺寸	Product Size	550*516*204mm	550*516*204mm	550*516*204mm
包装尺寸	Packing Size	655*590*165mm	655*590*165mm	655*590*165mm

JD-1045W

(MAX Cable dia 13mm)

Led Street Light



JD-1045A



注：包装尺寸为外尺寸  
本表所示技术参数均在环境温度25℃，湿度35%的实验室环境中测得。

Packing size is outer size of box  
All parameters are measured at 25℃ ambient temperature, 35% humidity experiments

产品尺寸 Product Dimension

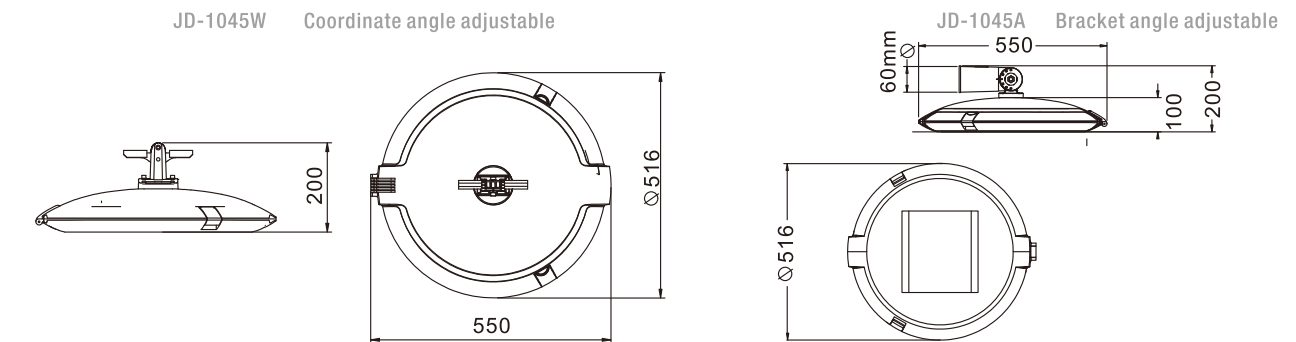

LED/Philip Lumileds 5050 or 3030  
Driver: philips/Meanwel/Inventronics

- Modern fashion design of appearance, made the light become an artwork, Integrated with the environment perfectly, to made is as top project.
- Used in high strength aluminum die casting material, surface anit-ageing electrostatic spray processing, super resistance to corrosion.
- Hightransparent tempered glass cover, high strength impact resistance.
- Input Voltage: AC100-240V, 50/60Hz, IP66, Ik08
- Angle adjustable : +15° ~ -15°
- Different type lens for choice
- Windy area : 570 cm<sup>2</sup>
- Spare parts for choice
  - 10 kv/20kv SPD
  - 0-10v dimming driver
  - auto switch
- 5 years warranty

配光曲线图 Light Distribution Curve

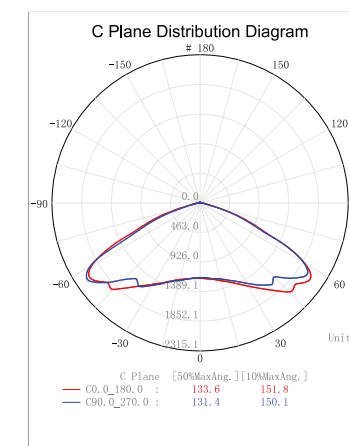

60W

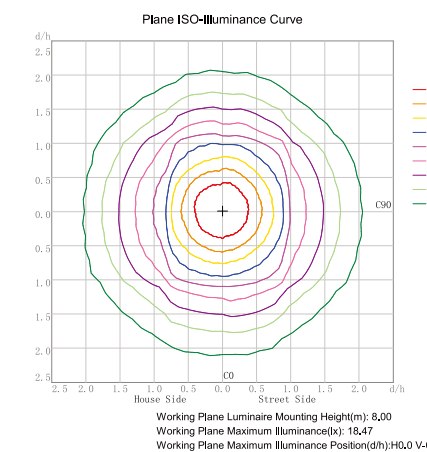

AC100-240V 输入电压 Input Voltage	Hz 50/60 频率范围 Frequency Range	PF >0.92 功率因数 Power Factor	<15% 总谐波失真 THD	CRI 75 显示指数 Color Rendering Index	-40~45℃ 工作环境温度 Temperature of Working Condition	10~90% 工作环境湿度 Humidity of Working Condition	70000h 使用寿命 Life Time	IP66 防护等级 Protection Grade
-------------------------------------	--	-------------------------------------	----------------------	--	---	---	-----------------------------	----------------------------------



# Led Garden Light

## JD-1046A



### 5050/3030 led, 130-140lm/w Meanwell/Philips/Osram driver

Used in high strength aluminum die casting material,surface anit-ageing electrostatic spray processing,super resistance to corrosion.  
 High transparent tempered glass cover,high strength impact resistance.  
 Input Voltage:AC100-240V,50/60Hz,IP66,1k09  
 Different type lens for choice  
 Windy area:815 cm<sup>2</sup>  
 Spare parts for choice  
 10 kv/20kv SPD  
 0-10v dimming driver  
 auto switch  
 5 years warranty

CE CB

#### 技术参数 Specification

产品型号	Product Code	JD-1046A 30W	JD-1046A 60W	JD-1046A-100W
电流 ( mA)	Electric Current	400mA/800mA (5050)/800mA (3030)	800mA (5050)/1600mA (3030)	63mA 5050/84mA 3030
LED数量	LED Quantity	24PCS 5050/72PCS 3030	48PCS 5050/144PCS 3030	64pcs 5050/192pcs 3030
额定功率	Rate Power	30W	60W	100W
色温	Color Temperature	6500/4000/3000k	6500/4000/3000k	6500/4000/3000K
初始光通量	Luminous Flux	3000lm/6500k	6000lm/6500k	150lm/w(5050) 140lm/w(3030)
输入电压	Input Voltage	AC100-277V	AC100-277V	AC100-277V
频率	Frequency Range	50/60Hz	50/60Hz	50/60Hz
显色指数	Color Temperature	Ra75	Ra75	Ra75
工作环境温度	Temperature of working condition	-40℃-50℃	-40℃-50℃	-40℃-50℃
工作环境湿度	humidity of working condition	20-90%	20-90%	20%-90%
LED 寿命	LED life time	100000h(L70)	100000h(L70)	100000h(L70)
防护等级	Protection Grade	IP66	IP66	IP66
安装管径	Installation Pipe Dia	Φ76mm/Φ60mm	Φ76mm/Φ60mm	Φ76mm/Φ60mm
安装高度	Installation Height	3-5m	6-8m	8-10m
净重	Net Weight	8.05kg	8.52kg	8.9kgs
毛重	Gross Weight	9.23kg	9.52kg	10kgs
产品尺寸	Product Size	550*516*561mm	550*516*561mm	550*516*500mm
包装尺寸	Packing Size	690*590*165mm	690*590*165mm	655*590*165mm

注:包装尺寸为外尺寸  
 本表所示技术参数均在环境温度为25℃,湿度35%的实验室环境中测得。

Packing size is outer size of box  
 All parameters are measured at 25℃ ambient temperature, 35% humidity experimental environment.

#### 产品尺寸 Product Dimension

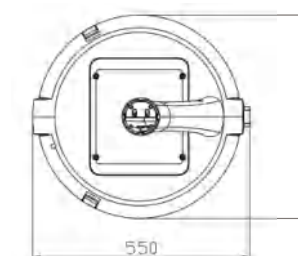
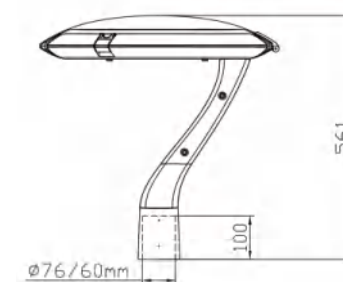

#### 配光曲线图 Light Distribution Curve

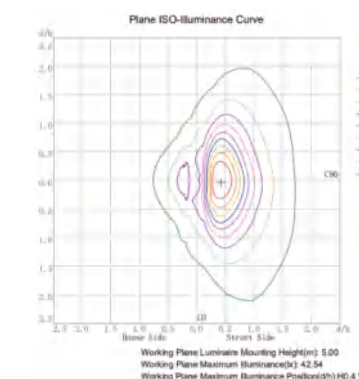
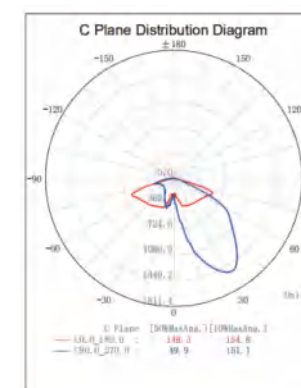

AC100-277V 输入电压 Input Voltage	Hz 50/60 频率范围 Frequency Range	PF >0.92 功率因数 Power Factor	<15% 总谐波失真 THD	CRI 75 显色指数 Color Rendering Index	-40~50℃ 工作环境温度 Temperature of Working Condition	20~90% 工作环境湿度 Humidity of Working Condition	70000h 使用寿命 Life Time	IP66 防护等级 Protection Grade
-------------------------------------	--	-------------------------------------	----------------------	--	---	---	-----------------------------	----------------------------------