

Zhejiang Xuhui New Energy Technology Co., Ltd.

Email : xuhui@cifisun-power.com
WhatsApp / Tel / Wechat : +8615270988758



HIGH VOLTAGE ENERGY STORAGE SYSTEM BATTERY

User Instruction

This manual introduces high-voltage lithium batteries. Before installing the battery, please read this manual and carefully follow the instructions during the installation process. If you have any questions, please contact our company immediately for consultation and clarification.











Catalogue

1. Symbol Description	4
2. Safety Precautions	5
2.1 Before Connecting	5
2.2 In Using	5
3. Introduction	6
3.1 Features	6
3.2 Specification	7
3.3 Equipment interface instruction	9
4. Safe Handling of Lithium-iron ESS Batteries Guide	12
4.1 Solution Diagram	12
4.2 Danger Label	12
4.3 Tool	12
4.4 Safety Gear	13
5. Installation and operation	13
5.1 Package items	13
5.2 Installation Location	13
5.3 Installation Steps	13
5.4 System turns on	14
5.5 System turns off	14
6. Emergency Situations	14
6.1 Battery Leakage	14
6.2 On Fire	14
6.3 Wet Batteries	15
6.4 Damaged Batteries	15
7. Remarks	15
7.1 Recycle and Disposal	15
7.2 Maintenance	15
Parts List	15
Maintenance Record	16
Dear user.thank you for selecting our product,Please fill in and keep the warranty card for better services.	16

(Revision History)

Ver.No.	Date	Revised Content	Reasons for Change	Reviser	Approve
A0	2023.09.14	First Edition	First Draft	ZhangDigen	
A1	2024.03.07	Second Edition	Parts List	ZhangDigen	

1. Symbol Description

	Do not place near open fire or flammable materials.
	A potential hazard exists when the equipment is working. Wear personal protective equipment during operation.
	Warning electric shock. Power off the equipment before any operation.
	Grounding: indicate PE cable connection position.
	Do not place in areas accessible to children.
	Keep the battery away from open fire or ignition sources.
	Read the product and operation manual before operating the battery system.
	Label for Waste Electrical and Electronic Equipment (WEEE) Directive (2012/19/EU).
	The certificate label for CE.
	Recycle label.

2. Safety Precautions



Alert

- 1) It is important and necessary to read the user manual carefully (and attachment) before installing or using battery. Failure to do so or to follow any instruction or warning in this document can result in electrical shock, serious injury, and death, or damage battery, potentially rendering it unusable.
- 2) When battery is stored for a long time, it is required to charge once every 6 months, and the SOC should be no less than 50%.
- 3) After battery module cannot be discharged, it needs to be recharged within 12h.
- 4) Do not connect power terminal reversely.
- 5) All power supplies must be disconnected during maintenance.
- 6) Please contact the supplier within 24 hours if there is something abnormal.
- 7) Do not use any liquid to clean the battery.
- 8) Do not expose battery to flammable or irritating chemicals or vapor.
- 9) Do not paint any part of battery, including any internal or external components.
- 10) Do not connect battery with PV solar wiring directly.
- 11) Do not install or use this product beyond provisions of the manual.
- 12) Direct or indirect damages caused by the above reasons are not covered by warranty claim.



Warning

2.1 Before Connecting

- 1) Please check the external packaging condition before unpacking. If it is damaged, contact corresponding local retailer.
- 2) After unpacking, please check the products and spare parts according to spare parts list. If the product is damaged or missing, please contact your local retailer.
- 3) Connect to specified matching inverter.
- 4) Before installation, be sure to cut off the grid power and make sure battery switch is on OFF mode.
- 5) It is prohibited to connect the battery and AC power directly.
- 6) All electrical wiring must be connected in accordance with local regulations.
- 7) Please ensure that electrical performance of battery system is compatible with the equipment.
- 8) The installation onsite shall be equipped with fire-fighting facilities that meet relevant requirements, such as fire sand, dry powder fire extinguisher, etc.

2.2 In Using

- 1) If battery system needs to be moved or repaired, power must be cut off and battery is completely shut down.
- 2) It is prohibited to connect battery with different types of battery.
- 3) Do not connect battery to faulty inverter.

-
- 4) Except for personnel from The Company or other authorized personnel, batteries shall not be opened, repaired or disassembled. The company shall not bear any liability or responsibility caused by violation of any safety operation or design standard, production standard, equipment safety standards or any other standards or requirements.

3.Introduction

This Stacked mode battery is a new energy storage product developed and produced by The Company, which can provide reliable power supply for all kinds of equipment or systems.

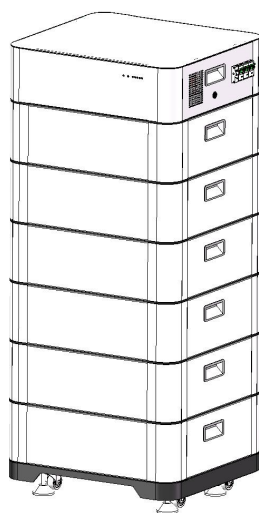

Figure 3-1

3.1 Features

- 1) Built-in start function to reduce current impact.
- 2) When multiple modules are series connected, module addresses are set automatically.
- 3) Support for upgrading the battery module from the upper controller through CAN communication.
- 4) The module is non-toxic, non-polluting and environmentally friendly.
- 5) Cathode material is made from LiFePO₄ with safety performance and long cycle life.
- 6) Battery management system (BMS) has protection functions including over- discharge, over-charge, over-current and high/low temperature.
- 7) The system can automatically manage charge and discharge state and balance voltage of each cell.
- 8) Flexible configuration, multiple battery modules can be connected to expand capacity and power.
- 9) Adopted self-cooling mode rapidly reduced system entire noise.
- 10) The module has less self-discharge, up to 6 months without charging it on shelf, no memory effect, excellent performance of shallow charge and discharge.

Functions

Protection and Alarm	Management and monitor
Charge/Discharge End	Cell Balance
Over voltage Charging Protection	Intelligent Charge Model
Under Voltage Discharging Protection	Charge/Discharge Current Limit
Charge/Discharge Over current Protection	Capacity Retention Calculate
High/Low Temperature Protection	Soft start
Short Circuit Protection	History Record

3.2 Specification Parameters

No.	Items	Specification
1	Product Name	Rechargeable Lithium Iron Phosphate Module
2	Module Model	WD-51.2
3	Battery Type	LFP 1P16S
4	Nominal Capacity	5.12kWh(*Module Qty)
5	Usable Capacity	4.6kWh (*Module Qty, 90% DOD)
6	Nominal Voltage	51.2V(*Module Qty)
7	Working Voltage	46.4~57.6V(*Module Qty)
8	Charging Voltage	56V(*Module Qty)
9	Max. Charge Current	50A(*Module Qty)
10	Max. Discharge Current	100A(*Module Qty)
11	Communication	RS485 , CAN
12	Storage Temperature	0°C ~ 45°C (Recommended)
13	Storage Humidity	≤85% (RH)
14	Working Temperature	Charging: 0°C ~ 50°C Discharging: -20°C ~ 50°C
15	Working Humidity	≤95% (RH) No Condensation
16	Working Altitude	≤2000m
17	Ingress Protection	IP20
18	Protective Class	IP20
19	Weight	~46kg(*Module Qty)
20	Dimension	550mm*500mm*171mm(1 Module)
21	Design Life	10 Years (25°C)
22	Cycle Life	> 6000 (25°C) ,80% EOL
23	Scalability	Module: Max. 8

Dimensions

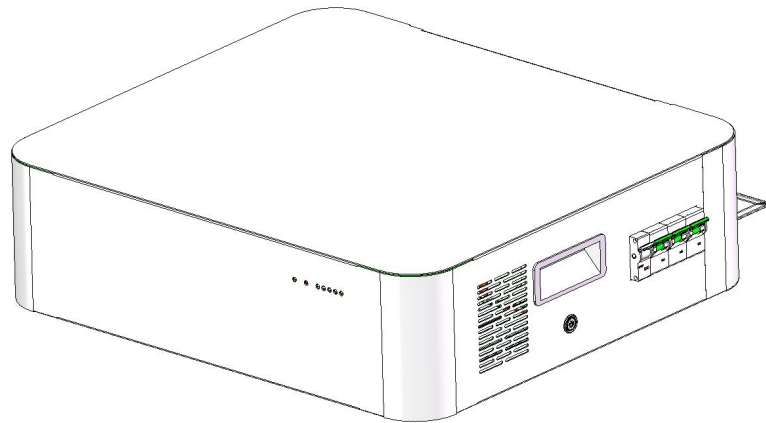

High voltage box

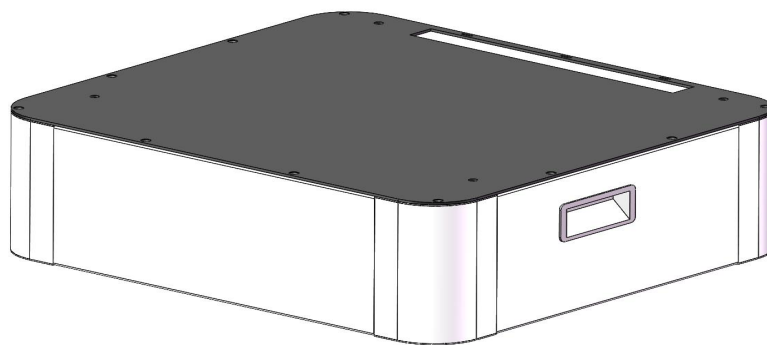

Battery module

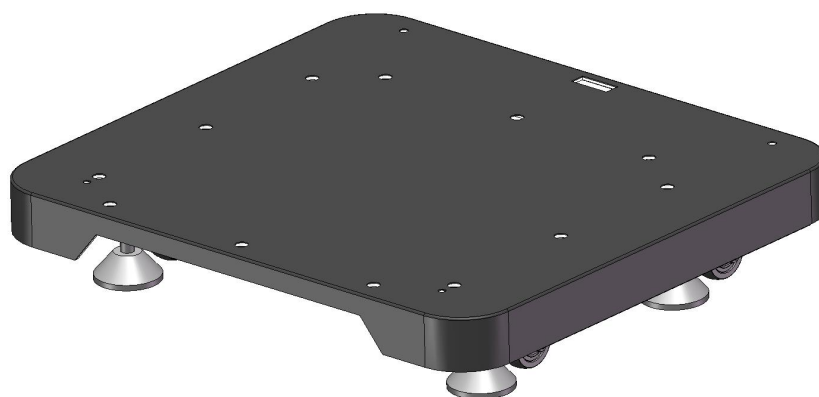

Pedestal

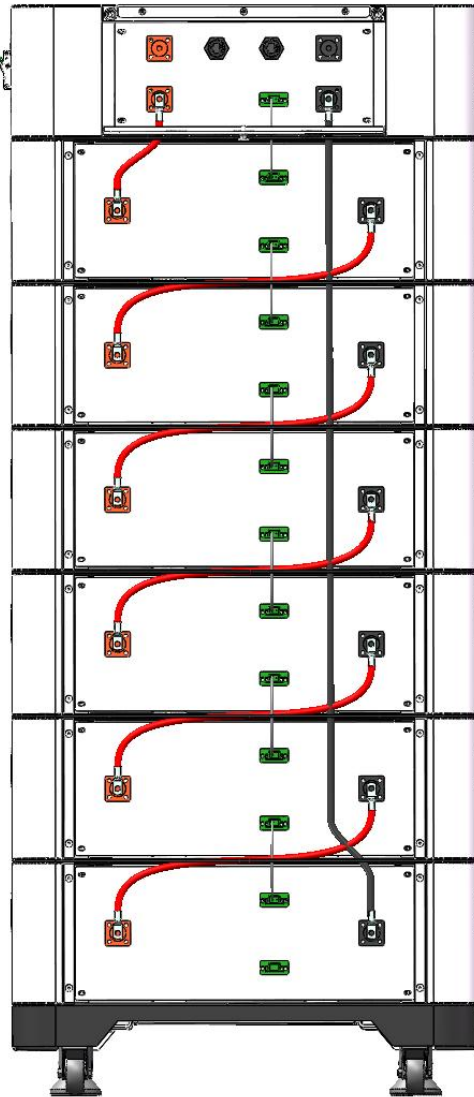
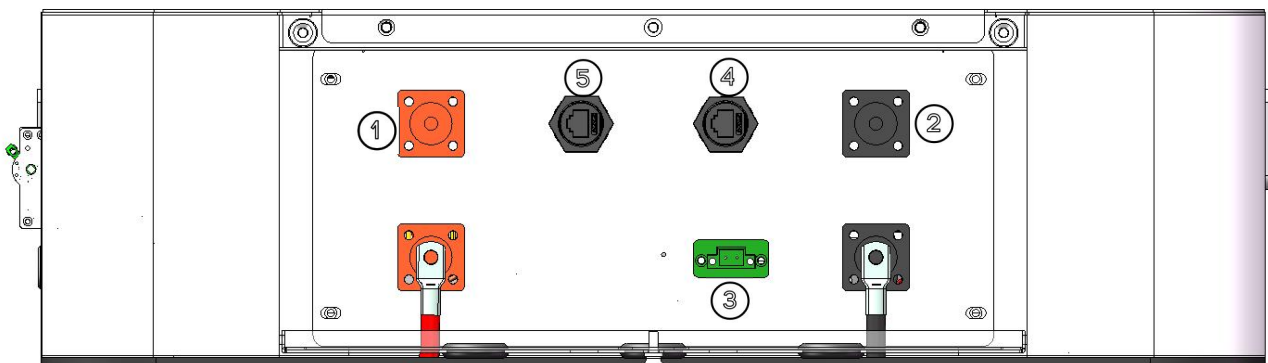

Figure 3-2

3.3 Equipment interface instruction



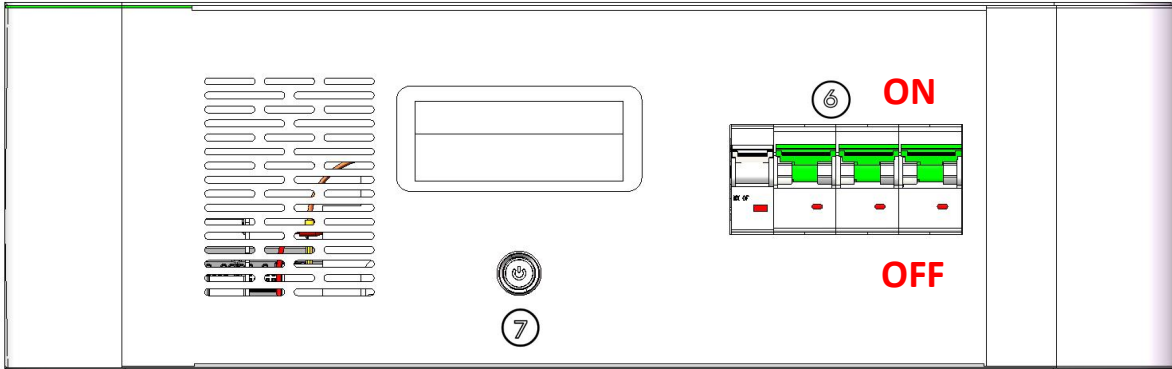

Figure 3-3

- ① **Positive terminal:** battery positive output
- ② **Negative terminal:** battery negative output
- ③ **PORT:**Slave communication
- ④ **PCS:** battery communication with PCS by RJ45 8P8C
- ⑤ **DEBUG:** Maintenance inspection port
- ⑥ **Breaker:** control circuit output, turn the switch to ON when use
- ⑦ **Start button:** System start switch, Press the button BMS will works

➤ **Start**

Start button: When battery is dormant, press the START button to start the battery module.

➤ **Operating mode indication**

The start button led lighting to show the battery system is running or having alarm.

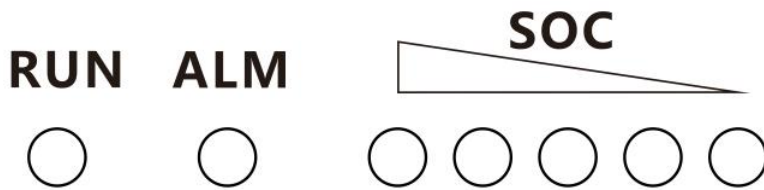

➤ **Breaker**

When the circuit breaker is pushed to the ON position, Positive Power Terminal will connect with the HV+ battery cont actor and Negative Power Terminal will connect with the battery HV-, on the other hand, when the circuit breaker at OFF position both connection will off.

Attention:

It is strictly prohibited to turn off the circuit breaker switch first when the inverter is charging and discharging the battery

➤ **PCS port**

Be used to communicate with inverter or upper battery.

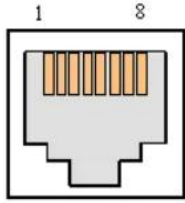

Pin	Definition
1	/
2	/
3	CAN1G
4	CAN1H
5	CAN1L
6	RS485G
7	RS485A
8	RS485B

➤ **DEBUG port**

Maintenance inspection port

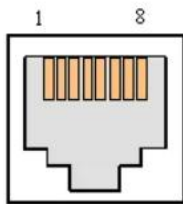

Pin	Definition
1	CAN0H
2	CAN0L
3	/
4	CAN1H
5	CAN1L
6	/
7	RS485A
8	RS485B

➤ **port**

Slave communication

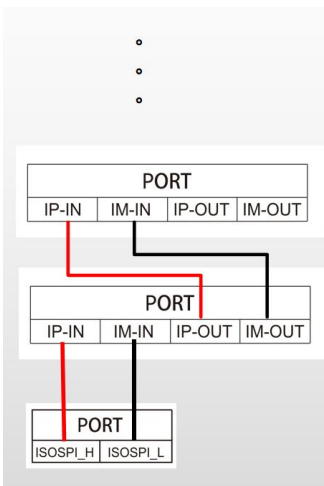

Pin	Definition
1	ISOSPI-H -----IP-IN
2	ISOSPI-L -----IM-IN

4. Safe Handling of Lithium-iron ESS Batteries Guide

4.1 Solution Diagram

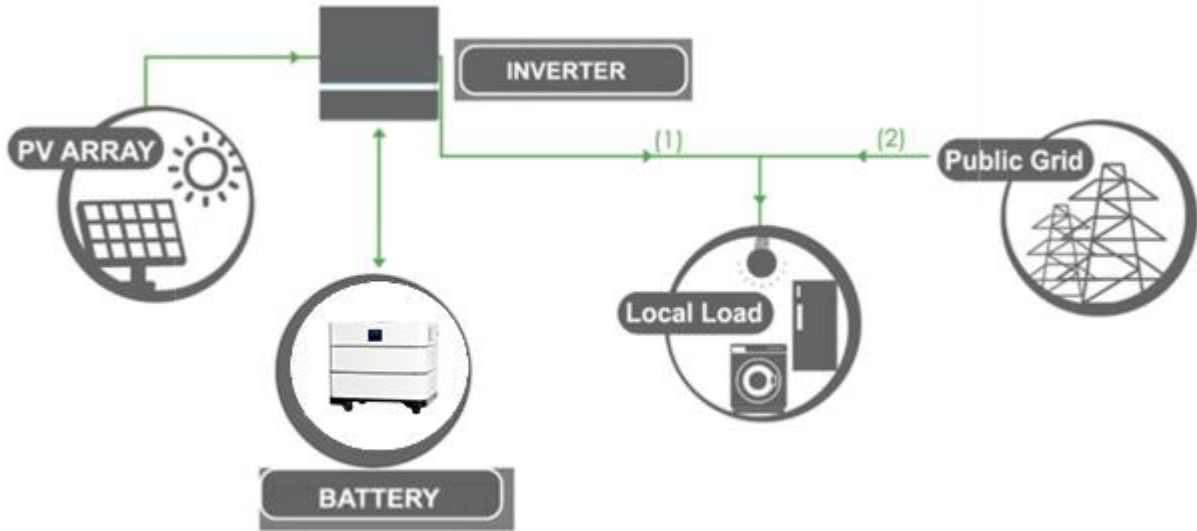

4.2 Danger Label



Figure 4-2

4.3 Tool



Wire Cutter



Modular Crimping Plier



Screwdriver



Electric drill

Note

Properly use insulated tools to prevent accidental electric shock or short circuits. If tools are not insulated, cover the entire exposed metal surfaces of available tools with electrical tape except their tips.

4.4 Safety Gear

It is recommended to wear the following safety gear when dealing with battery pack.



Insulated Gloves



Safety Goggles



Safety Shoes

5. Installation and operation

5.1 Package items

Unpacking and check the Package items

1) For battery module package:

- Battery Module

2) For packing box of high voltage box:

NOTE: Power and communication cables connect to inverter belongs to the packing box of high voltage box.

5.2 Installation Location

Make sure that installation location should meet the following condition:

- 1) The area should be completely water-proof.
 - 2) The floor should be flat and level.
 - 3) No flammable or explosive materials.
 - 4) The ambient temperature is within the range from 0°C to 45°C.
 - 5) The temperature and humidity are maintained at a constant level.
 - 6) There is just a little dust and dirt in the area.
 - 7) The distance from heat source should be more than 2 meters.
 - 8) The distance from air outlet of inverter is more than 0.5 meters.
 - 9) Installation areas should avoid direct sunlight.
 - 10) No forced ventilation requirement for battery module, but please avoid installing in a closed area.
- Ventilation shall avoid high salinity $\leq 30\%$, humidity $\leq 85\%$ and ambient temperature of 0 ~ 45 °C.

5.3 Installation Steps



Warning

- 1) Follow local electric safety and installation policy, a suitable breaker between battery system and inverter is required.

-
- 2) All installation and operation must follow local electric standard and requirements.
 - 3) When battery modules are connected in series, the system should be powered off before installation operation.

5.4 System turns on

Warning: Double check all the power cables and communication cables. Make sure the voltage of the inverter/PCS is same level with the battery system before connection. Check all the power switches are OFF.

System turns on step:

- 1) Check all cables are connected correctly. Check grounding is connected.
- 2) If necessary, turn on the switch at inverter`s battery side or between inverter and battery. If possible, turn on AC or PV power source to wake up inverter.
- 3) And turn on power switch.
- 4) Switch all the battery racks` Isolating Switch to on position.
- 5) Press the start button in sequence. If there is a button switch on the battery layer, first turn on the metal start button of the battery, and finally turn on the start button of the battery box control box(PDU).
- 6) If no alarm ,the battery system will be ready for charging and discharge with PCS.

5.5 System turns off

When failure or before service, must turn the battery storage system off:

- 1) Turn off inverter or power supply on DC side.
- 2) Turn off the switch between PCS and battery system.
- 3) Switch Isolating Switch to off position. (Switch off the slave battery firstly, finally switch off the master battery).

Note

- 1) One battery system shall just have one master, all the others are slaves. (The one on the extreme side connected to inverter is the master battery.)
- 2) It is forbidden to switch off the Isolating Switch during charging and discharging.

6. Emergency Situations

6.1 Battery Leakage

If the battery pack leaks electrolyte, avoid contact with the leaking liquid or gas. If one is exposed to the leaked substance, immediately perform the actions described below

- 1) Inhalation: Evacuate contaminated area and seek medical aid.
 - 2) Contact with eyes: Rinse eyes with flowing water for 15 minutes and seek medical aid.
 - 3) Contact with skin: Wash affected area thoroughly with soap water and seek medical aid.
- Ingestion: Induce vomiting and seek medical aid.

6.2 On Fire



NO WATER!

Only dry powder fire or carbon dioxide extinguisher can be used; if possible, move the battery module to a safe area before it catches fire.

6.3 Wet Batteries

If the module is wet or submerged in water, do not let people access it, then contact us or an authorized dealer for technical support. Cut off all power switch on inverter side.

6.4 Damaged Batteries

Damaged batteries are dangerous and must be handled with utmost care. They are not fit for use and may pose a danger to people or property. If the module seems to be damaged, pack it in its original container, then return it to authorized dealer.



Warning

Damaged batteries may leak electrolyte or produce flammable gas.

7. Remarks

7.1 Recycle and Disposal

In case a battery (normal condition or damaged) needs disposal or needs recycling, it shall follow the local recycling regulation (Suggest Regulation (EC) N° 1013/2006 among European Union) to process, and using the best available techniques to achieve a relevant recycling efficiency.

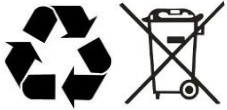

7.2 Maintenance

Check installation environment such as dust, water, insect etc. Make sure it is suitable for IP20 battery system. Connection of power connector, grounding point, power cable and screw are suggested to be checked every year.

Parts List

Item	Part Name	Description	Unit	Quantity
1	Battery layer	Optional up to 8 floors	PCS	3-8
2	PDU	Battery box control box	PCS	1
3	Pedestal		PCS	1
4	Battery power cable	6AWG Red	PCS	6
5	Battery power cable	6AWG Black	PCS	1
6	Communication cable	Battery series connection cable	PCS	6
7	Hexagon screw	M6*14	PCS	14

Maintenance Record

Dear user.thank you for selecting our product,Please fill in and keep the warranty card for better services.

Attn: _____ Product No.: _____

Tel: _____ E-mail: _____

Purchase Date: _____

Address: _____

Maintenance Record			
Date of repair	Content	Maintenance Personnel	Note