

H
A
R
D
W
A
R
E

KAYNE BUILDING MATERIAL CO. LTD.

Our standard is :
Quality & Service

优质的服务和质量是我们一贯的宗旨



Web: www.kayne-bm.com

Add: 58th Minghui city garden 1st floor, 2nd Rd chengnan. Dali town,nanhai, foshan city. Guangdong province.,China

Tel: 0086 757 8557 5751 Mobile: 139 2863 6001



208B



B23



3H-F009



032# Steel shaft Hinge



MKB-07



MKB-02



034# Hinge



F004# Extended latch bolt



CX-111 latch bolt 237mm



Alu anti-theft device



014# auto lock



S008



D002 double lock w/ key



3085 lock body



7066 lock body



HX-ZB18SX handle



2085 lock body

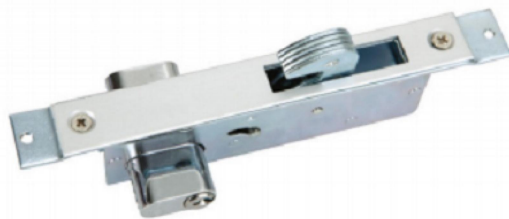

#41055 hock lock



HX-ZM10D handle

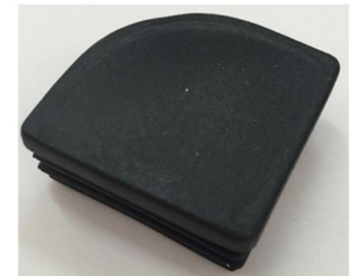

40*40 plastic cover



Lock cylinder



70 (35+35) Dual-lock cylinder w/ polished chrome



7066 lock cylinder



A55 Alu handle



113# double roller

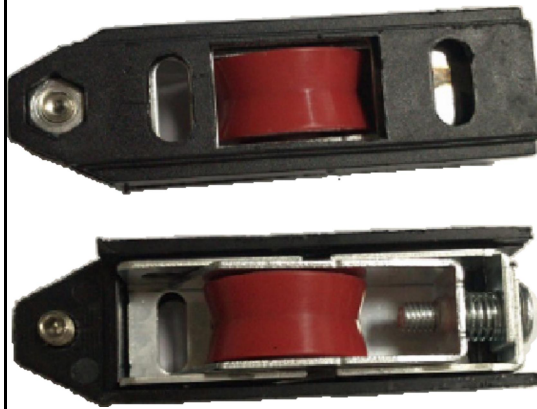

112# single roller



6.8*7 woolen 3P2L

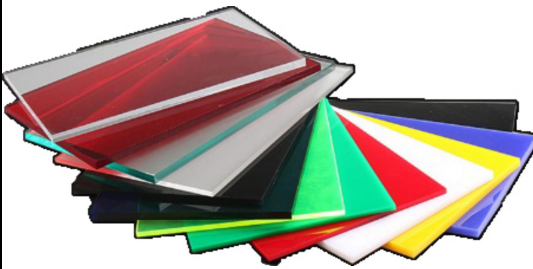

Acrylic board



Alu plastic panel

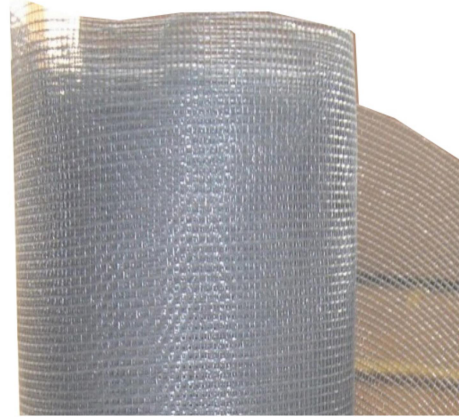

glass fiber mesh

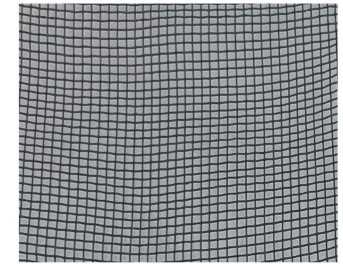

grey Nylon mesh

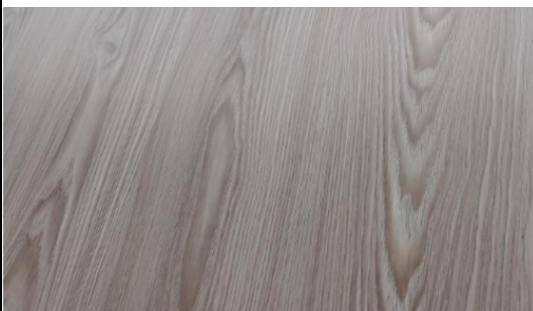

1816# Melamine MDF 5mm



Cherry Melamine MDF



blue Melamine MDF



grey Melamine MDF



round door closer

1601# door closer

VVP V-98 door closer

Dustproof Cylinder for Bolt



Lock clip sanding

Top clip

Angle clip 5 mm



Expansion bolts 10x70

4.8x18

4.8x25 Self-tapping screws

7.5x92 cement screws



4.8*60



4.8*35



4.8*13

Round head self-tapping screws



B-22-4.5



5#B T133

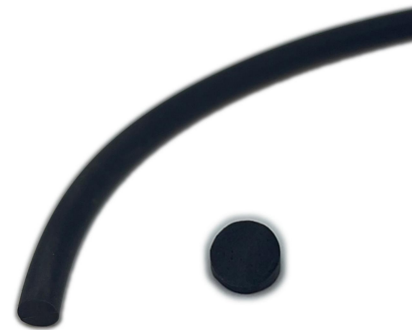

J-15-5

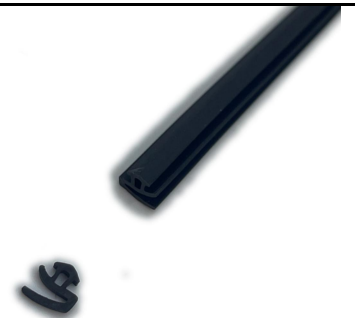

K-369-4.5



T382 L



plastic conner

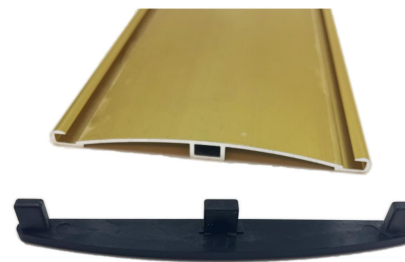

3H-K03



Transparent corners



Door stopper

Intercom



grinding wheel w/ Rounded Edges

grinding wheel w/ straight edges

Round-head impact drill

Straight shank twist drill



C028# ALU handle

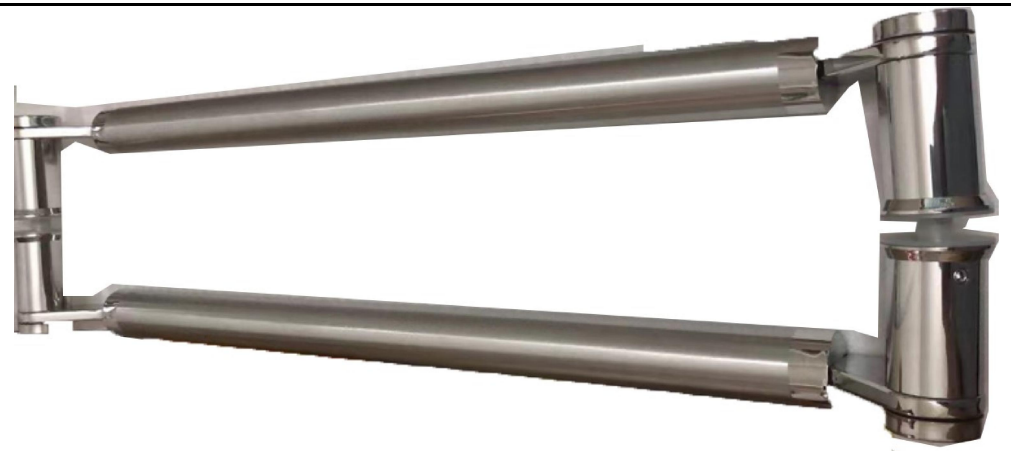

KT-1081# handle

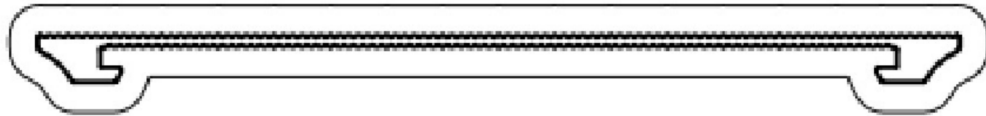

YL-3H-K01

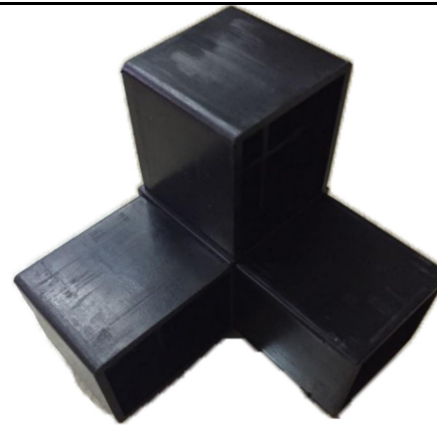

3-way pipe fittings-square corners



3-way pipe fittings-rounded corners



TOPBOND 920



TOPBOND 926

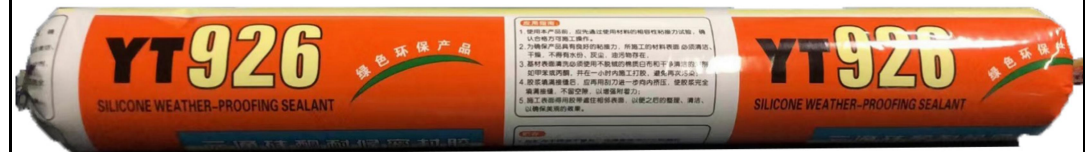

TOPBOND 926 529ml



10-inch compound saw



1232B#12inch Rotary miter saw



Rail drainage punching machine



Drainage & Hook Cover Two-Column Machine



Multifunctional portable edging machine



Profile milling machine



Lifter



Bearing 5194967(822)



Bearing 5194971(822)



Double-cone sealing ring 6Y0855(822)



Glass cutter

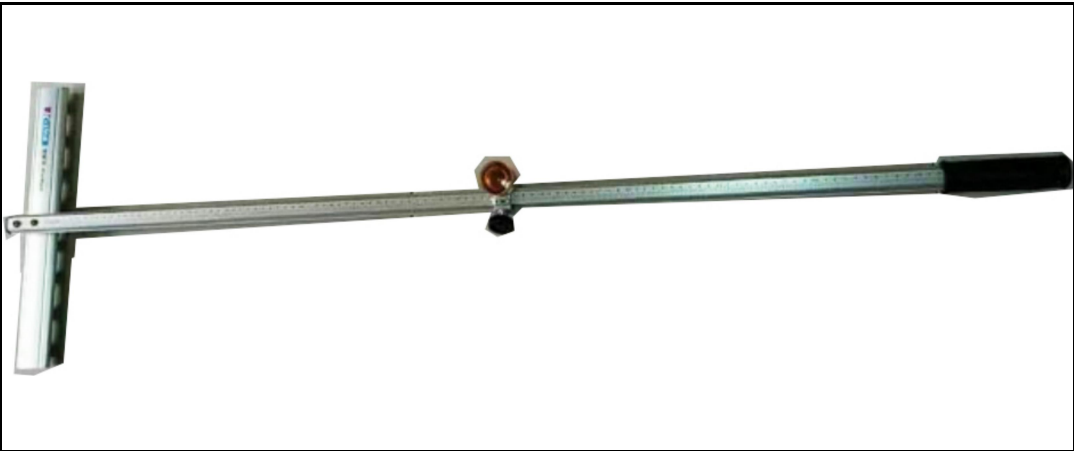

Glass Push - Type Cutter -medium grade



Glass Push - Type Cutter -high grade

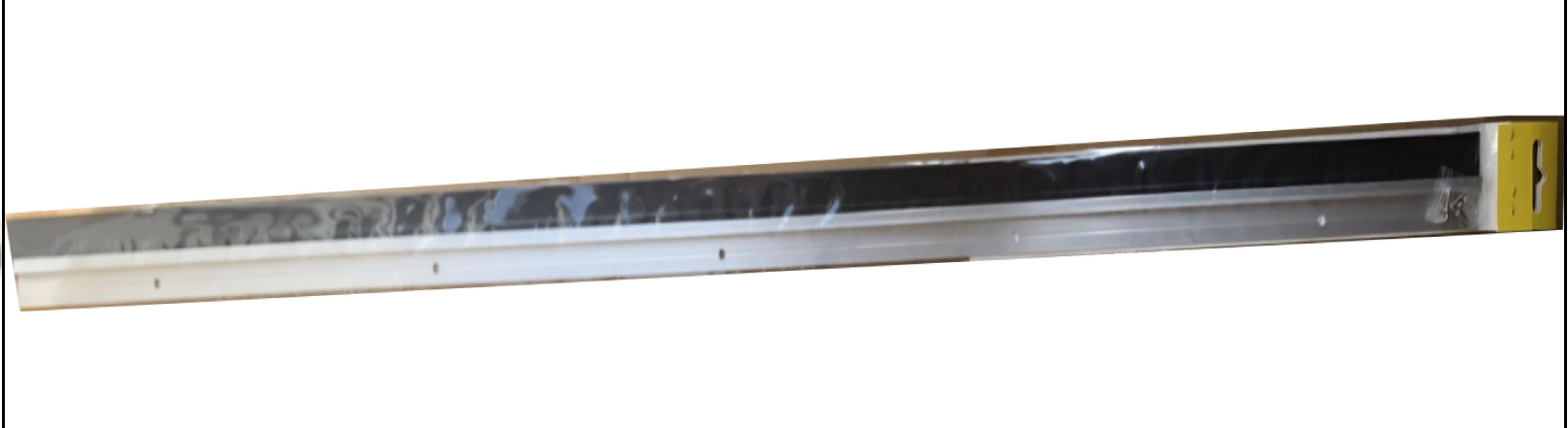
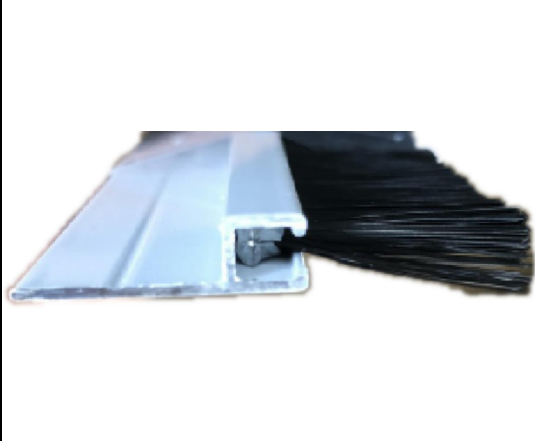

Dustproof brush

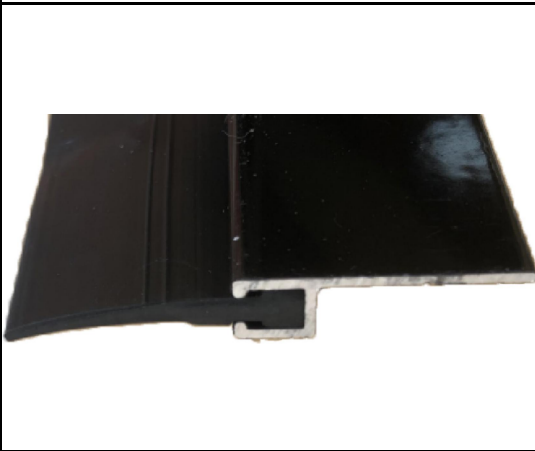

Water barrier strip



SEM822 Oil filter element 5402611 (W010519260)



SEM822 Fuel coarse filter element 5658925 (1000964807)



Water removal and reliable filter element 5184447



Fine fuel filter element 5651152



Oil filter 1000424655A



Oil return filter mesh (5228468) 660



SEM822 Air filter 5184406(W010517226)

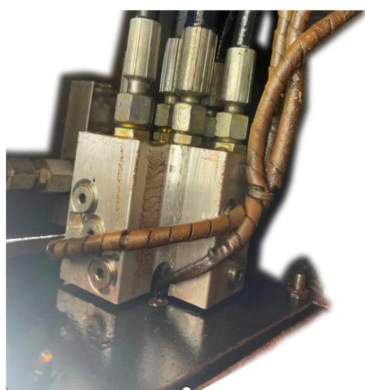

SEM919 Pilot valve (5227776)



SEM660B Pilot accumulator 5190299(W110021000)



Oil dipstick assembly W43012460 5486410

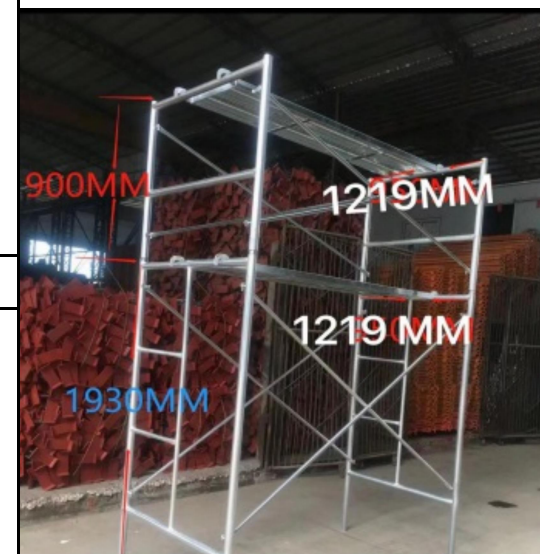

Scaffold



919# Central deflection locking cylinder W42000564 90X5



919# Working valve W42046000 3701232,4 RH



919# Working valve W42022000 3701261,4+ RIPP



ADAPTER 5217271



Tooth holder 50TIP 5217267



660B Sleeve gear 50 rock king (5217267)

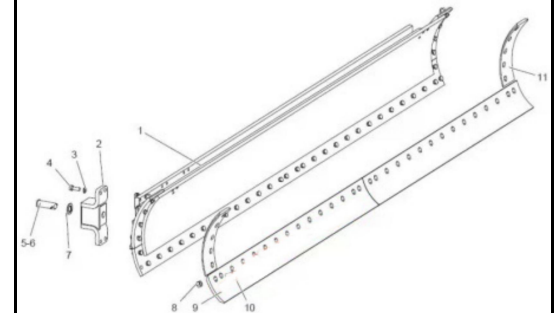

SEM660B Auxiliary blade plate 5332655



SEM822 Angular cutter plate (5202004 L+5202003R)



SEM822 Auxiliary blade plate (5202005 I+5202006 II)



919# B060461603 16-300HV Washer

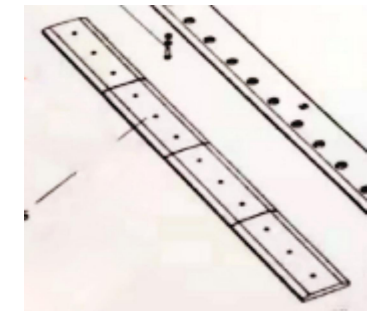

SEM660B 5332655



DT9324-1 rotary type



919# Fuel injector 5984191G



919# b040811255 Bolt

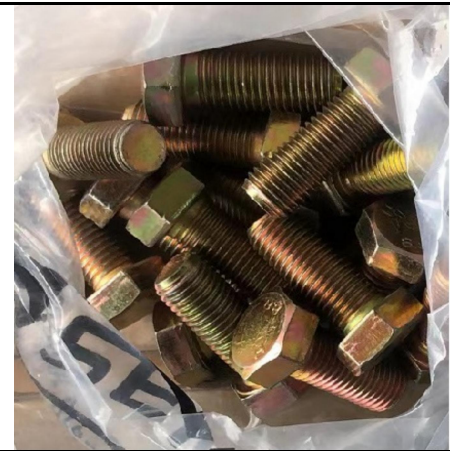

919# B040911640 Bolt



W46000297 5242220

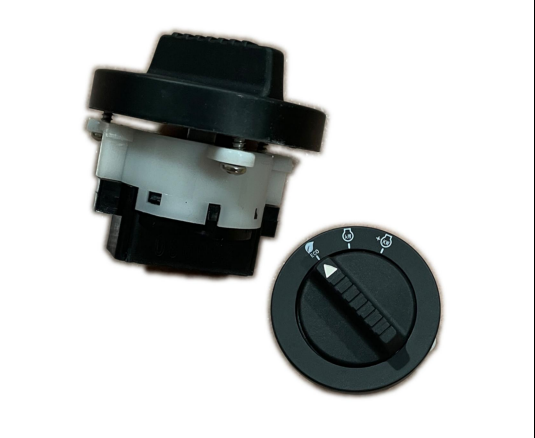

W46000405 5189642



L STRIP-WEAR W03060003 5358199



poly-v belt 6PK1475 5590240



W44000009 6380176



ADAPTER AS 5217543



STRIP-WEAR 5358198



air booster pump.5400716

alternator 5229738

tyre 5386003

INNER TRUBE 5402782



curtain 1

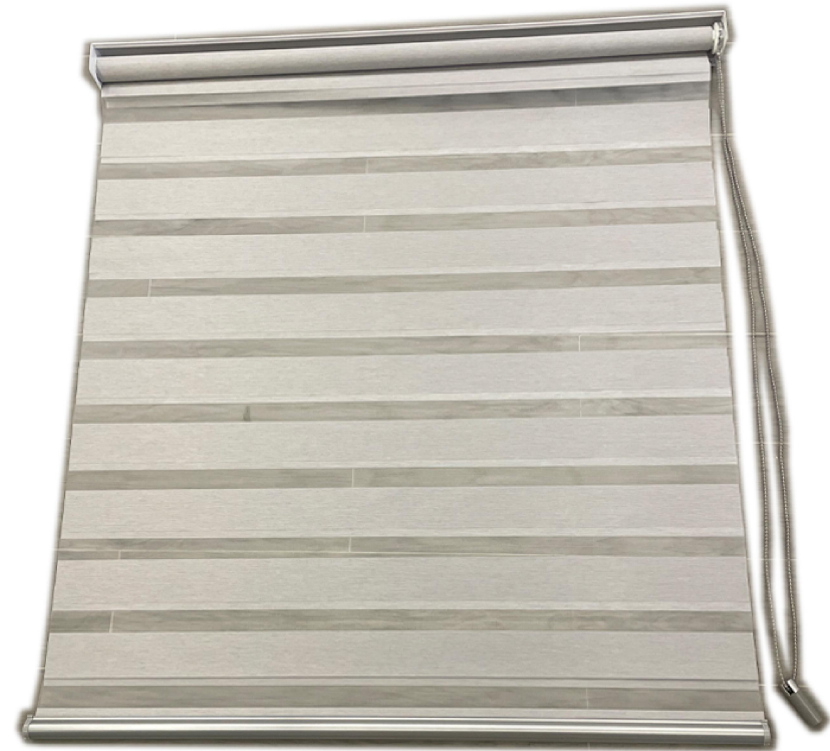

curtain 2

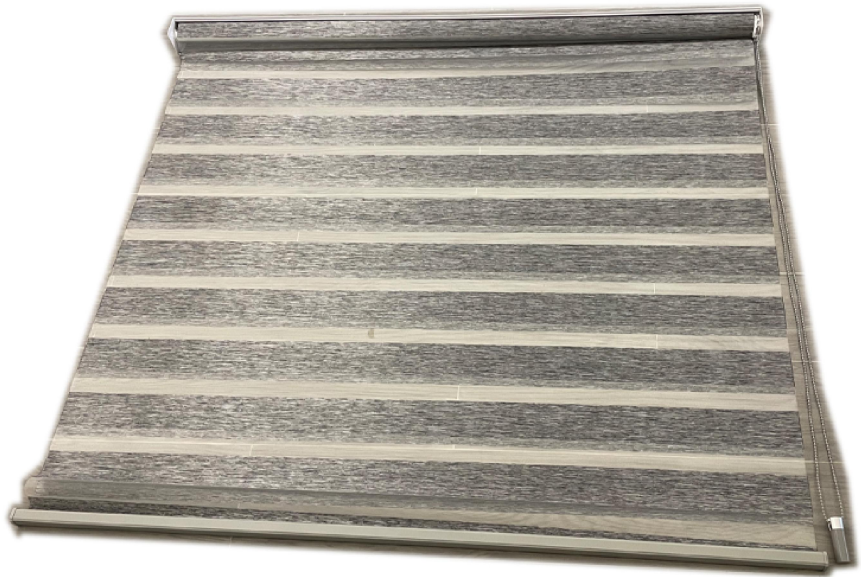

curtain 3



CURTAIN FITTING

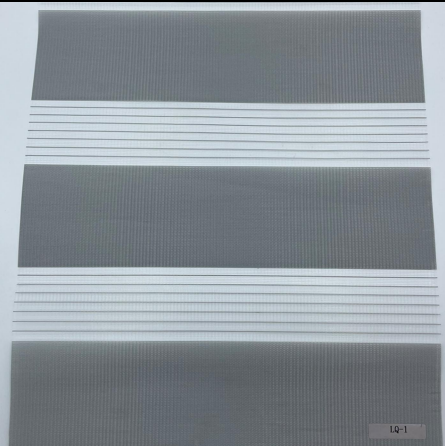

LQ01



LQ02



LQ03

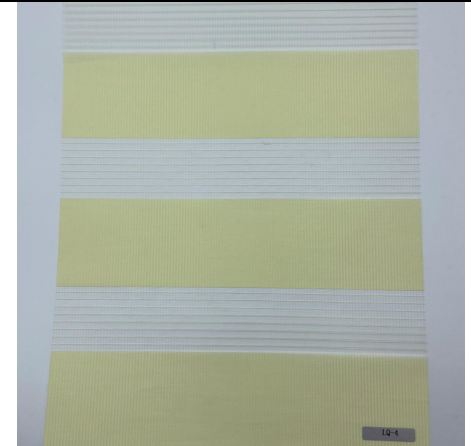

LQ04

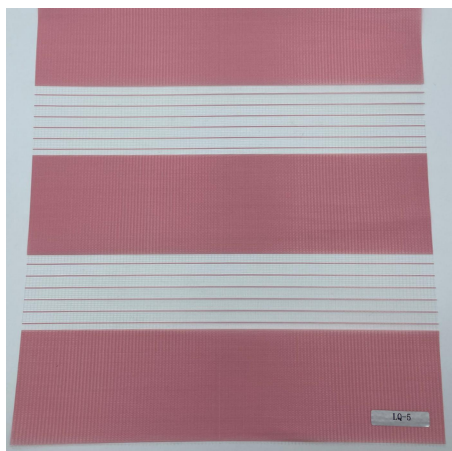

LQ05

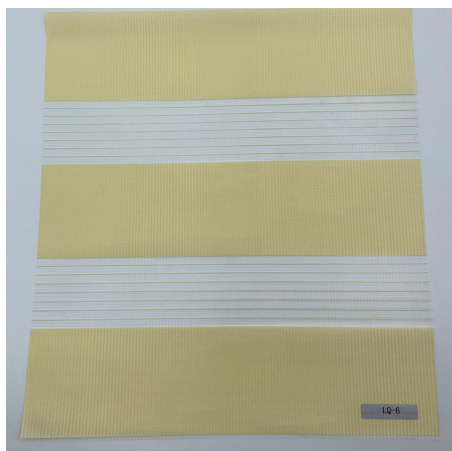

LQ06

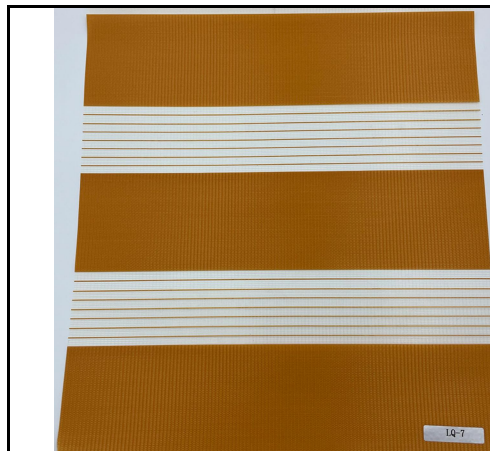

LQ07



LQ08

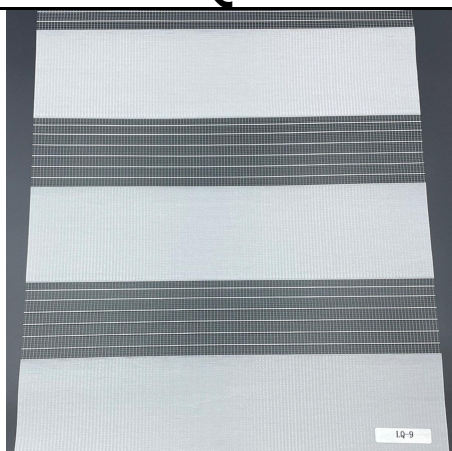

LQ09

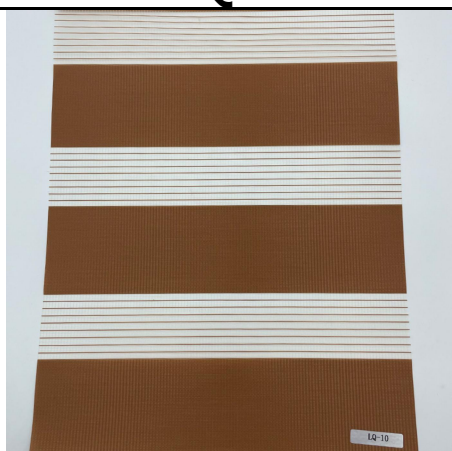

LQ10



LQ11

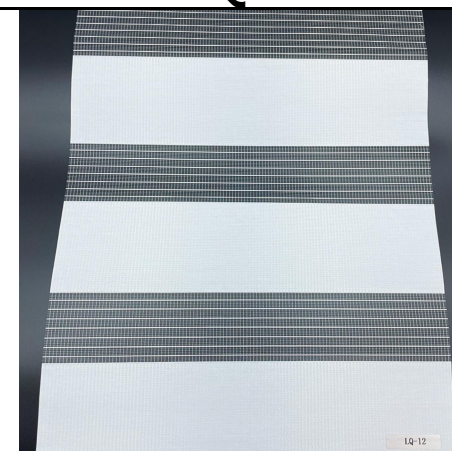

LQ12

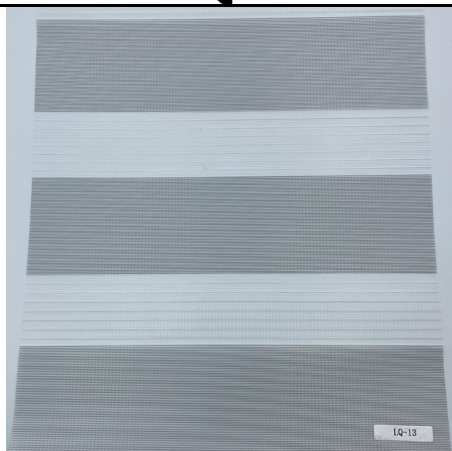

LQ13

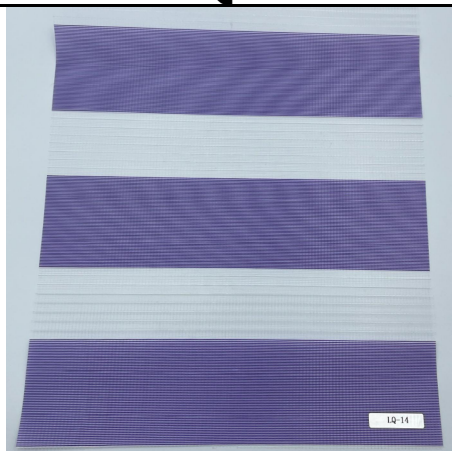

LQ14



LQ15



LQ16

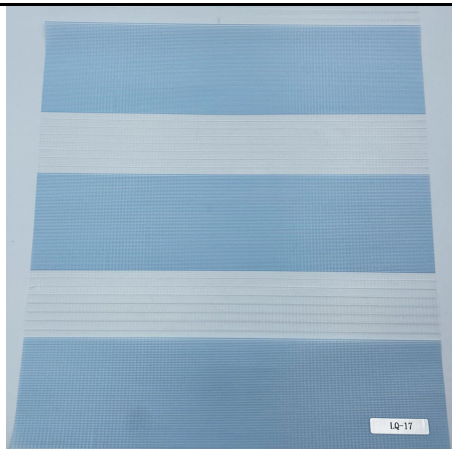

LQ-17

LQ17

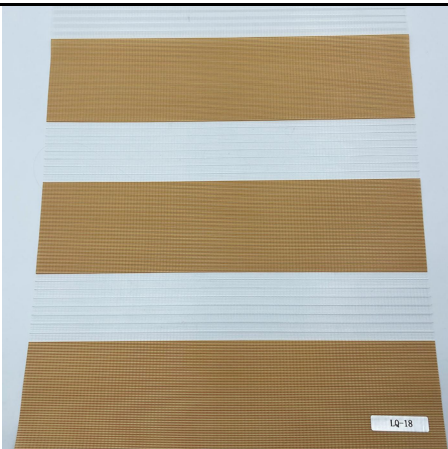

LQ-18

LQ18



LQ-19

LQ19



LQ-20

LQ20

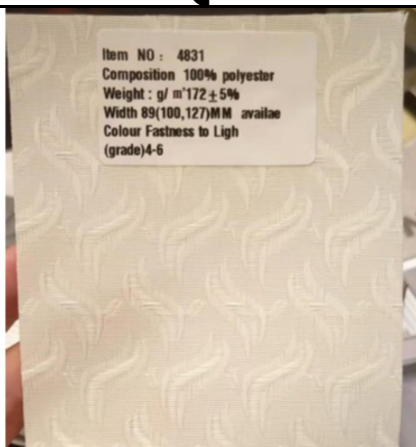

Item NO : 4831
Composition 100% polyester
Weight : g/ m'172 ± 5%
Width 89(100,127)MM availae
Colour Fastness to Ligh
(grade)4-6

4831#Curtain fabric

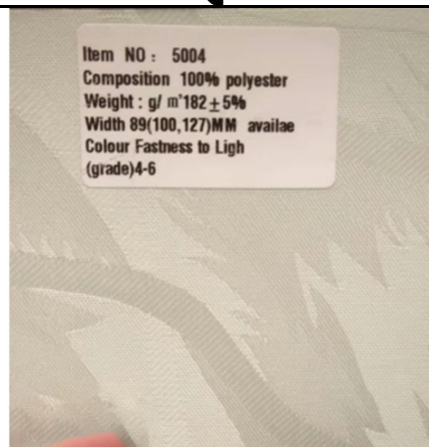

Item NO : 5004
Composition 100% polyester
Weight : g/ m'182 ± 5%
Width 89(100,127)MM availae
Colour Fastness to Ligh
(grade)4-6

5004#Curtain fabric



GV082020013

W:89MM

GV082020013#Curtain fabric

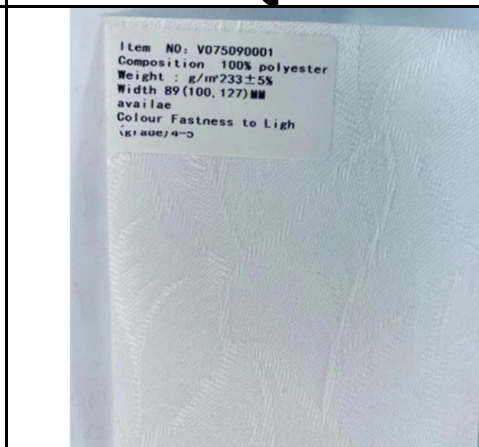

Item NO: V075090001
Composition 100% polyester
Weight : g/m'233 ± 5%
Width 89(100,127)MM
availae
Colour Fastness to Ligh
(grade)4-6

V075090001#Curtain fabric

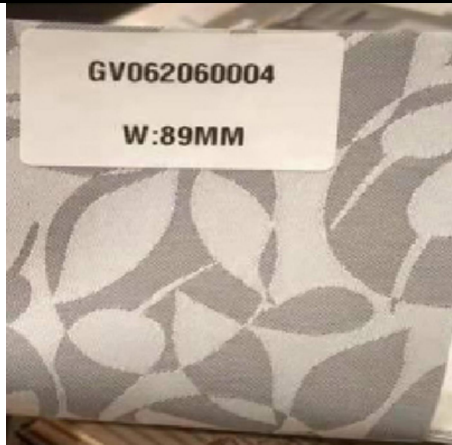

GV062060004

W:89MM

V06206004#Curtain fabric



Window grilles paper E0073B Narrow



White frosted solar film



curtain beading