

Solar inverter air conditioner

Use installation instructions



360150594

- Installation work should be done by professionals.
- For your convenience, please read this manual carefully and follow the steps in the manual.
- Please keep the manual properly for easy reference.

Packing list

Number	name	quantity	Number	name	quantity
1	Indoor unit	1	8	Installation sheet	1
2	Outdoor unit	1	9	Nail shot	5
3	Hanging plate	1	10	Connecting pipe	1
4	Remote controller	1	11	Packing belt	1
5	AAA battery	2	12	Drain pipe	1
6	Connect wire	1	13	Wall sleeve	1
7	Use installation instructions	1	14	Sealant	2

Contents

Precautions	2
Working principle and special functions	4
Maintenance	5
Troubleshooting	7
Remote control instructions	9
APP connection guide	12
Indoor and outdoor unit installation	14
Electrical connections	24
PV panel installation	28
Packing List	32

⚠ Follow matters

- Be sure to use the special fixed socket for the air conditioner, otherwise it may cause electric shock or fire.
- Be sure to insert the power plug firmly, otherwise it may cause electric shock or fire.
- During thunderstorms, be sure to turn off the power switch, otherwise accidents may occur.
- Be sure to use a dedicated circuit with an air switch and leakage circuit breaker, and ensure that there is an appropriate capacity.
- If abnormal phenomena (burnt smell, etc.) are found, please cut off the power immediately and contact the dealer or customer service center immediately. Otherwise, the machine may malfunction, causing electric shock or fire.
- When cleaning the air conditioner, be sure to turn off the air conditioner and unplug the power cord, otherwise it may cause electric shock or injury to you.
- When the air conditioner is not used for a long time, be sure to disconnect the power supply of the air conditioner.
- Be sure to ground reliably! The grounding wire should be connected to the dedicated grounding device of the building. Do not connect the ground wire to the gas pipe, Water pipes and other places.
- The power cord of the air conditioner is damaged. In order to avoid danger, it must be replaced by the manufacturer, its maintenance staff or professionals.
- When using with burning appliances, the room should be ventilated regularly, otherwise it will cause incomplete combustion of hypoxia and cause safety All accidents.
- Please clean the filter regularly. The clogged filter will directly affect the cooling and heating effects of the air conditioner. Increased power consumption, easy to output It is malfunctioning.
- Keep the air inlet and outlet of the indoor and outdoor units unobstructed. Otherwise it will affect the cooling and heating effects, and even cause malfunctions.
- Do not accumulate debris around the outdoor unit. Once the debris enters the machine and touches the internal electrical components, it may cause component failure or malfunction. Smoke, fire, etc.
- The temperature setting should be appropriate. Proper adjustment of the set temperature can prevent waste of power and save energy.
- Pay attention to whether the outdoor unit installation base or bracket is damaged. If the base or installation bracket is damaged and do not repair it, the unit may fall and cause damage.

ACDCBLW solar panel installation recommendations

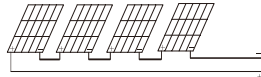
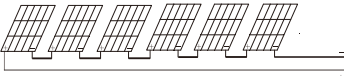
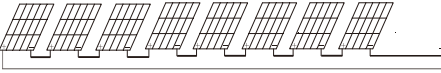
MODEL	Solar panel series	Quantity
12000BTU/1.5P/1Ton		(280-400W) 4pcs (400-500W) 3pcs
18000BTU/2P/1.5Ton		(280-400W) 6pcs (400-500W) 5pcs
24000BTU/3P/2Ton		(280-400W) 8pcs (400-500W) 7pcs

Trial run

1. Turn on the power and turn on the cooling mode;
2. After the compressor has been protected for three minutes, observe whether the cold air is normally blowing out of the room and whether there is abnormal noise in the indoor and outdoor machines;
3. Switch the mode to "heating" mode, observe whether the indoor heating is normally blown out, and whether the indoor and outdoor machines have abnormal noise;
4. Set the mode to "air supply" (high wind) mode and observe whether there is strong wind blowing out of the room;
5. Press other buttons on the remote control to check whether the whole machine is working normally;
6. Switch the mode to "refrigeration" and run for 1h, and observe whether it can drain normally;
7. After confirming that the machine is running normally, press the "on/off" button to stop the test run.

★4 Electrical installation

In some cases, the current or voltage generated by the component may be greater than the best operating current or voltage under its standard test environment (STC) Voltage. Therefore, when determining the original rating and load value, the open circuit voltage and open circuit current of the component under STC should be multiplied by 1.25. When determining the appropriate wire and fuse, the short-circuit current should be multiplied by 1.25 in accordance with Section 690-8 of the USNEC.

Electrical installation rules

- 4.1 The components of the same configuration should be used on the same photovoltaic power generation system.
- 4.2 If photovoltaic modules are connected in series, the total voltage is equal to the sum of the voltages of each module.
- 4.3 If photovoltaic modules are connected in parallel, the total current is equal to the sum of the currents of each module.
- 4.4 The component provides prefabricated connectors for electrical connection of the system.
- 4.5 The cross-sectional area and connector capacity of the cable selected by the system should meet the maximum system short-circuit current.
- 4.6 When installing the module, the end with the junction box on the back faces upwards.
- 4.7 When designing the system, avoid loops.
- 4.8 Check whether the wiring is correct before starting.
- 4.9 Ensure that the connection is secure and tight. The plug must not be subjected to external pressure and can only be used to connect the circuit.
- 4.10 Components and component brackets should be properly grounded. Use the recommended connection terminal and connect the grounding cable well.
- 4.11 It is recommended to use a grounding wire accessory (terminal lug) to connect the grounding cable. (The wiring lug supplier is Cat.No.GBL4-DBT).
- 4.12 Most of the contacts in the conductive connection should be fixed. Ferrous metals used in conductive connections should be treated with anticorrosion to prevent rust.

★Maintenance

- 5.1 When the surface of the module is dirty, clean the glass surface of the module. Use a soft spongesoaked in water to clean.
- 5.2 Regular mechanical and electrical inspections shall be carried out every 6 months to ensure that the component joints are clean and the connection is reliable.
- 5.3 If you have any questions, please check by qualified personnel.
- 5.4 Attention, follow the maintenance instructions of all parts used in the system, such as brackets, charging rectifiers, inverters, batteries, etc.
- 5.5 If there is snow, you can use a soft brush to clean the surface of the component

⊘ Prohibited matters

- Do not unplug or insert the power cord plug with wet hands, otherwise there is a danger of electric shock.
- Do not cut off the power supply by pulling the power cord, otherwise it may cause electric shock or fire.
- Do not use damaged power cords, plugs and sockets, otherwise it may cause electric shock or fire..
- Never cut off the power supply when the air conditioner is running, otherwise it may cause electric shock or fire.
- Do not repair the air conditioner by yourself. Incorrect repairs may cause accidents or fires.
- Do not install the air conditioner in a place where flammable and explosive gas leaks, otherwise it will cause fire, explosion and other dangers.
- Never wash the air conditioner with water, otherwise an accident or electric shock may occur.
- Do not touch the aluminum foil fins of indoor and outdoor units to prevent injuries.
- Do not put your hands or other objects into the air inlet and outlet of the indoor and outdoor units, otherwise it may cause serious injury.
- Do not let the elderly and children use the air conditioner without supervision.
- Do not stand, sit or place any objects on the outdoor unit, otherwise it may cause accidents such as falling or falling.
- Do not install the air conditioner in a place where flammable and explosive gas leaks, otherwise it will cause fire, explosion and other dangers.
- Do not place other electrical appliances in the lower part of the indoor unit. The dripping of water droplets may cause electrical malfunctions and electric shocks.
- Do not blow air-conditioning or heating directly to the human body, animals or plants for a long time, so as not to cause harm to them.
- Do not use the air conditioner for the preservation of precision equipment, food, animals, plants or artworks, otherwise it will affect its quality.
- When the air conditioner is running, do not open the doors and windows of the room for a long time, otherwise it will affect the performance of the air conditioner.

Air conditioner working principle and special functions

The working principle of refrigeration:

The air conditioner absorbs heat from the indoor air and transmits it to the outside for discharge, thereby reducing the indoor ambient temperature, and its cooling capacity decreases as the outdoor temperature rises.

Heating principle:

The air conditioner absorbs heat from the outdoor air and transmits it to the room to dissipate it, thereby increasing the indoor temperature, and its heating capacity decreases as the outdoor temperature decreases.

Anti-freezing function:

If the air conditioner is in low temperature cooling operation, frost will appear on the surface of the indoor heat exchanger. When the temperature of the indoor heat exchanger drops below 0°C for a continuous period of time, the outdoor unit will stop operating.

Defrosting function:

When the outdoor temperature is low and the humidity is high, the heat exchanger of the outdoor unit will form frost after the air conditioner runs for a period of time, which will reduce the heating effect. At this time, the air conditioner will automatically start the defrost mode.

1. When defrosting, the outdoor unit may emit steam, which is caused by rapid defrosting, which is a normal phenomenon.
2. The heating mode resumes operation after defrosting.

Anti-cold air function:

In the "heating" mode, if the indoor heat exchanger does not reach a certain temperature in the following three states, the indoor fan will not reach the set wind speed to prevent cold air from blowing out (about two minutes):

1. Heating operation At the beginning;
2. After the automatic defrosting operation ends;
3. Heating at low temperature.

Heating and blowing residual heat function:

When the heating mode or automatic heating mode is running, the compressor and the indoor fan are turned off when the compressor and the indoor fan are in operation, and the compressor and the external fan are stopped. The upper and lower air deflectors are turned to the minimum air outlet position, and the inner fan runs in cold wind mode.

Breeze function:

In the following situations, the indoor unit may blow a weak wind, and the air deflector will automatically turn to a specific position:

1. When the compressor is turned on in the "heating" mode, and the compressor has not reached the opening conditions;
2. During the heating process, the temperature reaches the set value and the compressor stops running.

★Select location

3.1.1 The location where the module is installed should not be shaded or blocked all year round, and have sufficient sunlight

3.1.2 Solar photovoltaic modules rely on light to generate electricity. Please select an appropriate installation angle to ensure that the modules can achieve maximum Sun exposure

3.1.3 The selection of component location should meet the requirements of various electrical and fire protection codes.

3.2 Choose a bracket

3.2.1 The instructions and safety rules attached to the bracket should be followed

3.2.2 When the components leave the factory, the design has been completed.

Please do not try to change the structure or structure of the component for

3.2.3 For standard installation, use the four symmetrical mounting holes on the inner side of the frame to fix the module on the bracket

3.2.4 The brackets and other required materials (such as bolts, etc.) should be made of durable, rust-resistant, and UV-resistant materials production

3.3 Land installation

3.3.1 When installing on the ground, choose a suitable installation height to prevent the lower part of the module from being covered with snow for a long time when it snows in winter cover. In addition, make sure that the lowest part of the module is high enough to avoid being blocked or blown over by plants or trees. Sand and stone damage

3.3.2 Check the building codes used during roof installation to ensure that the building and its structure (roof, exterior

(View inside, bearing, etc.) have sufficient bearing capacity. When installing modules, make sure that the modules are installed on a fire-proof roof, and The roof slope angle is less than 5in/ft to ensure its fire rating

3.3.3 When the module is installed on the roof or building, make sure it is securely fixed and will not be damaged by strong wind or heavy snow

3.3.4 Ensure smooth ventilation on the back of the module (the minimum distance between the module and the mounting surface is 10cm).

3.3.5 When installing on the roof, the roof that needs to be penetrated when installing the fixed components should be properly sealed to prevent leakage.

3.4 Installation Guide

3.4.1 The components and supporting structure should be fixed with bolts through the mounting holes, which are only located on the rear flange of the frame (see Figure 1)position. No additional drilling is required.

3.4.2 Use appropriate anti-corrosion fastening materials

3.4.3 There are many different ways to tighten up or down (see Figure 2), and the installation method depends on the installation structure.

3.4.4 The installation design should be checked by a professional engineer. Installation design and procedures should comply with local regulations and all laws Designated functional departments

3.4.5. A torque wrench should be used during installation. The above figure shows the fixing method of the component and the supporting structure. M8 bolt in Figure 2) is 17Nm

Installation of PV panels

★Disclaimer

With the update of Volta technology, the relevant information of the existing manual will be improved without notice. This manual only for land installation and use, users and installers should carefully read and follow.

★General safety rules

- 2.1 The installation of solar photovoltaic power generation systems requires specialized skills and knowledge, which must be completed by professionally qualified engineers.
- 2.2 When the installer tries to install, operate and maintain the photovoltaic modules, please make sure that you fully understand the installation instructions here. In order to understand the risk of injury that may occur during installation.
- 2.3 Photovoltaic modules produce electricity when there is sufficient sunlight or other light sources. Please take corresponding protective measures when you should operate. To avoid direct contact between personnel and 30VDC or higher voltage.
- 2.4 Solar photovoltaic modules can convert light energy into direct current electricity, and the amount of electricity will change with the change of light intensity.
- 2.5 When the component has current or has an external power supply, the component must not be connected or disconnected.
- 2.6 When installing, using modules or wiring, opaque materials should be used to cover the modules in the solar photovoltaic module array. To stop power generation.
- 2.7 All local, regional and national laws and regulations shall be complied with, and construction permits shall be obtained if necessary.
- 2.8 There are no user-repairable original solar photovoltaic modules. Do not disassemble, move or modify any attached parts.
- 2.9 Do not wear metal rings, watch straps, earrings, nose rings, lip rings or other metal accessories when installing solar photovoltaic modules. Decorated.
- 2.10 Please do not install or operate modules in humid or windy conditions.
- 2.11 Do not use or install damaged components, and do not artificially condense light on components.
- 2.12 Only PV modules of the same model can be combined together. Avoid uneven cathodes on the surface of photovoltaic modules shadow. The shaded cells will become hot (the "hot spot" effect), which can cause permanent damage to the components.
- 2.13 When an accident occurs, please turn off the circuit breaker immediately.
- 2.14 Defective or damaged components may still emit electricity. If you need to carry it, please take measures to cover it to ensure. The pieces are completely shaded.
- 2.15 Keep children away from the module when transporting and installing the module.
- 2.16 Please keep the PV modules in the original packing box before installation.

Maintenance

Before inspection or maintenance work, be sure to turn off the power switch (including disconnecting the photovoltaic panel power supply), and unplug the power supply.

Clean the air filter

1. Remove the air filter

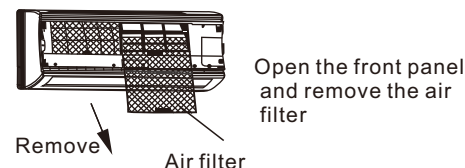

Note:
When removing the air filter, please be careful not to touch the metal part of the indoor unit because it may be scratched.

2. Remove the air filter and use a vacuum cleaner or wash it with water.

- If the air filter is too dirty, it can be washed with a warm water solution of neutral detergent.
- Do not wash with hot water (above 40°C) to avoid deformation



3. After washing with water, it should be allowed to dry before use.

- Do not use direct sunlight to dry the air filter or use fire to dry it.



4. Install the air filter.

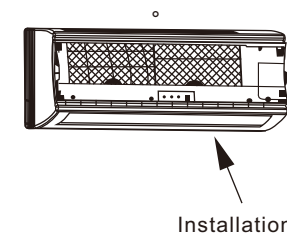

Clean the air conditioner shell

- (1) . Use a soft cloth dipped in clean water to wipe.
- (2) . Use a soft cloth dipped in a neutral detergent aqueous solution to wipe.

Note

- Hot water above 40°C can cause deformation or discoloration of the air conditioner casing.
- Volatile liquids such as thinner or gasoline can damage the air conditioner casing.

Seasonal inspection

- (1) . When the air conditioner is not used for a long time
 - ① Turn on the air conditioner in fine weather and keep the air conditioner in a ventilated state for 6-8 hours to remove the air conditioner in the humidity.
 - ② Use the remote control to turn off the air conditioner, cut off the power supply, and remove the batteries from the remote control.
 - ③ Clean the outdoor unit and cover it with a plastic protective cover.
- (2) . Check before the season change
 - ① Remove the protective cover of the outdoor unit.
 - ② Check the power cord and whether the connecting wire is damaged.
 - ③ Ensure that the entrance and exit of the outdoor unit air conditioner and the indoor unit are barrier-free.
 - ④ The drain pipe is not broken or flattened.
 - ⑤ Clean and reinstall the filter. (I.e. boot to use)

Note

- (1) . Do not put flammable and explosive materials near the air conditioner.
- (2) . Do not use the air conditioner for other purposes, such as drying clothes and preserving food.
- (3) . Please do not place the air conditioner close to other heat sources.
- (4) . If the power cord and connecting wire are damaged, be sure to cut off the power supply and ask after-sales personnel to repair it.
- (5) . The power cord of the air conditioner should be equipped with a dedicated wire and an air switch. Toxic and hazardous substances table

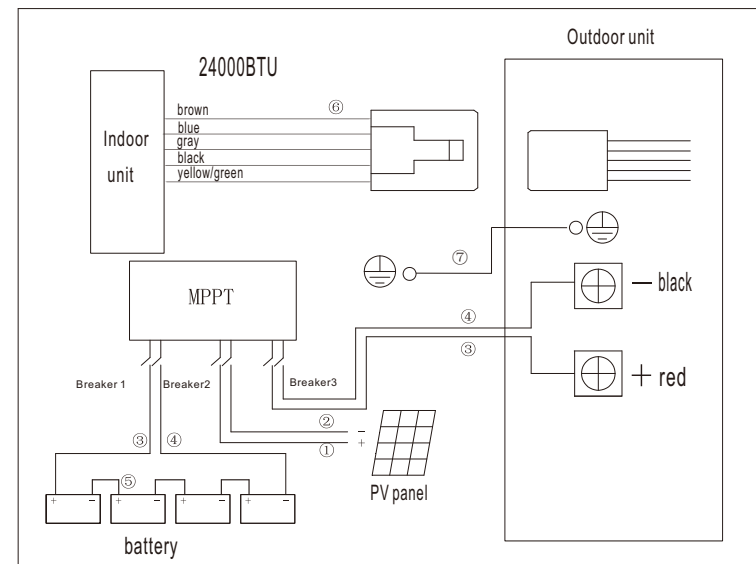

Outdoor unit wiring

Open the electrical cover on the right side of the outdoor unit, and wire according to the wiring diagram. Pay attention to pressing the wire through the crimping plate, the wire end must be firmly pressed on the terminal, no looseness is allowed, and the grounding wire must be connected to the designated position. After the wiring is connected, tie the connecting pipe, connecting wire and drain pipe with a cable tie. The cross section after binding is as shown in the figure below:

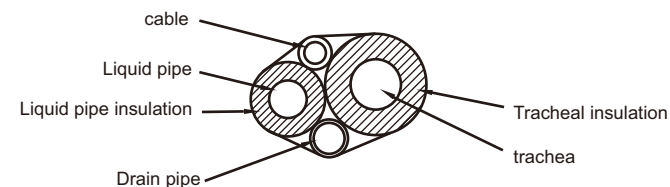

Note: Do not flatten the drain pipe when dressing!

DC48V solar air conditioning system recommended configuration

	9000-12000BTU 1-1.5HP/0.75-1Ton	18000BTU 2HP/ 1.5Ton	24000BTU 3HP/2 Ton
①	N*4mm ² /12AWG		
②	N*4mm ² /12AWG		
③	8mm ² /8AWG	16mm ² /6AWG	25mm ² /4AWG
④			
⑤			
⑥	4*1.0mm ² /18AWG		5*1.0mm ² /18AWG
⑦	(Indoor standard configuration) 1*1.0mm ² /18AWG		
PV panel	275W~350W (3*N) Remarks: Three blocks are connected in series and then connected in parallel		
MPPT	≥40A	≥60A	≥60A
Breaker 1	≥500V/40A	≥500V/60A	≥500V/80A
Breaker 2	≥500V/40A	≥500V/60A	≥500V/80A
Breaker 3	≥500V/40A	≥500V/60A	≥500V/80A
Remarks:	Open circuit voltage of PV panel(Voc) ≤MPPT PV/3		

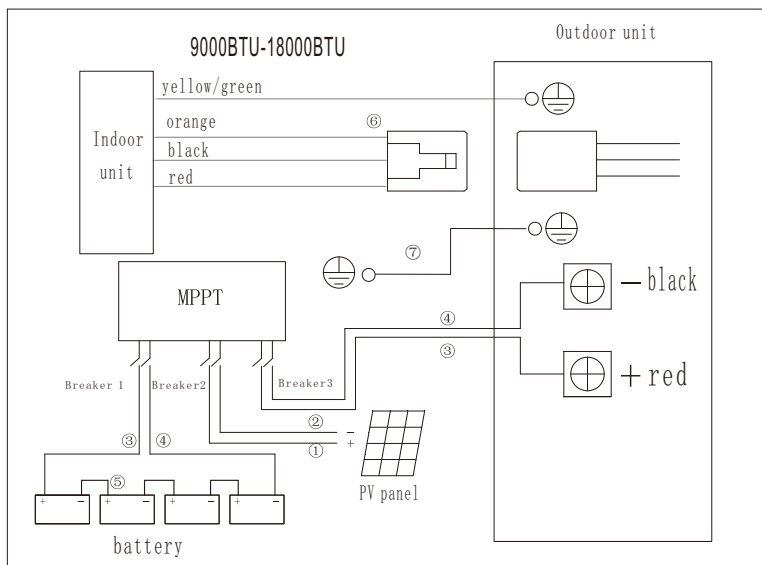

Fault and diagnosis

Before requesting maintenance and overhaul, please check according to the following points. If the fault cannot be cleared, please contact the maintenance personnel or Contact the seller

phenomenon	Check item
Not working	<ol style="list-style-type: none"> 1. Is the air switch in the dedicated circuit of the air conditioner closed? 2. Is the timer operation wrong? 3. Is the air conditioner in defrosting state? 4. Is the power switch turned on? 5. Whether the voltage is too high or too low, beyond the normal operating voltage range.
Cooling or heating not effectively	<ol style="list-style-type: none"> 1. Is the filter dirty? 2. Is the temperature setting wrong? 3. Are there any obstructions at the air inlet or outlet of the indoor unit? 4. Are the doors and windows open, and are there other heat sources (cold sources) indoors?
Loud running noise	<ol style="list-style-type: none"> 1. Similar to the sound of running water, this is the sound of refrigerant flowing in the machine. 2. Similar to the sound of exhaust, this is the start and end of the defrost function. The sound of the refrigerant flowing back in the pipeline (during heating operation). 3. Is the installation smooth?
The air conditioner blows out a peculiar smell when turned on	<ol style="list-style-type: none"> 1. The air conditioner itself has no peculiar smell, which may be caused by the accumulation of peculiar smell in the environment. <p>Solution: Clean the air filter.</p>
The remote control cannot control	<ol style="list-style-type: none"> 1. Is the dry battery exhausted? 2. Are the positive and negative electrodes of the dry battery reversed? 3. Is it within the receiving range? Or is it blocked by obstacles? 4. The air conditioner is subject to abnormal interference or frequent switching functions, and the remote control is occasionally out of control. At this time, just unplug the power plug and plug it back in to resume normal operation. 5. Is the remote control damaged?
White mist from the air conditioner	<ol style="list-style-type: none"> 1. Fog caused by condensation of cold wind due to high indoor humidity and large temperature difference at the air outlet. <p>Few indoor units</p>

phenomenon	Check item
Small amount of water dripping from indoor unit	1. The air humidity is high, and a small amount of condensation and dripping may occur during cooling operation.
Outdoor unit leaks	1. During cooling operation, the pipes or pipe joints will cause moisture condensation due to cooling. 2. The melted water remains during heating or defrosting operation. 3. The water droplets attached to the heat exchanger during heating operation.
After the air conditioner is stopped, it will start and not run immediately	1. This is the protection mechanism inside the machine, and it will operate automatically after waiting for 3 minutes. Indoor unit not delivered.
Indoor unit does not supply air	1. During the heating process, when the indoor heat exchanger temperature is low, stop the air supply to prevent blowing of cold air (about 2 minutes). 2. When heating, when the outdoor temperature is low or the humidity is high, the outdoor heat exchanger is more frosted and empty. The regulator will automatically defrost, and indoor air supply or breeze will be stopped for about 3-12 minutes. In during the defrosting process, water flows out or water vapor is generated. 3. During the dehumidification operation, the fan of the indoor unit sometimes stops to prevent condensation. Re-evaporate to suppress temperature rise.

Non-fault phenomenon

1. When the air conditioner starts and stops, sometimes there will be a "silk" sound of flowing water, which is the sound of refrigerant flowing and does not mean machine malfunction.
2. The air conditioner cannot be started immediately after it stops running, even if the air conditioner is on. Within three minutes after the air conditioner stops refrigeration, dehumidification, and heating do not start to operate, during which time the air conditioner operates in a ventilation mode.
3. Sometimes there is a peculiar smell in the room that is input into the air conditioner, causing the air to be blown out to smell bad. Wash the filter.
4. During heating operation, the indoor unit and outdoor unit stop air supply, but the compressor is still working. This is because the air conditioner is in defrosting operation. After defrosting, heating operation will resume.
5. During heating operation, the outdoor unit produces water or steam. This is a phenomenon caused by defrosting on the outdoor unit during defrosting operation, not a malfunction of the machine.
6. After the air conditioner stops running, the outdoor unit may have a "click" sound, which is caused by the balance pressure of the machine itself, not the machine malfunction.

ACDCBLW solar air conditioning system recommended configuration

		9000BTU - 12000BTU 1HP-0.75Ton / 1.5HP - 1Ton	18000BTU 2HP/ 1.5Ton	24000BTU 3HP/2 Ton
①	—	PV1-F4mm ² /12AWG		
②	—	PV1-F4mm ² /12AWG		
③	—	3*1.5mm ² /16AWG	3*2.5mm ² /14AWG	
④	—	4*1.0mm ² /18AWG (Indoor standard configuration)		
Breaker 1		DC1000V ≥16A		
Air switch 2		≥20A	≥25A	

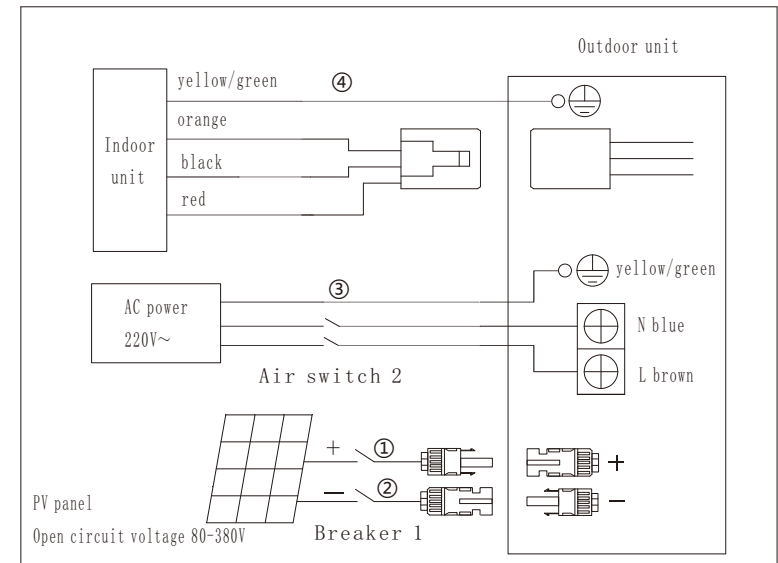

Electrical connections

⚠ caveat

1. All wiring should be correctly connected according to the circuit diagram, and the grounding wire should be connected firmly and reliably.
2. Do not use wires with connectors in the middle; do not use extension cords or multi-core wires, because these wires can cause heat, electric shock or fire. When the length of the connecting wire is not enough, please contact the seller or customer service center to re-equip a dedicated line.
3. Please straighten out the wires when wiring, so that it is convenient for crimping and crimping, and it will not cause the outlet cover to float.

⚠ Attention

1. Do not connect the grounding wire to the gas pipe, water pipe, telephone or lightning rod line or the grounding line of other products.
2. Once the indoor unit and outdoor unit are connected to the power supply, do not cut off the power within one minute, (system automatic setting) otherwise it will cause the air conditioner to operate abnormally.

Remote control instructions

Remote control function

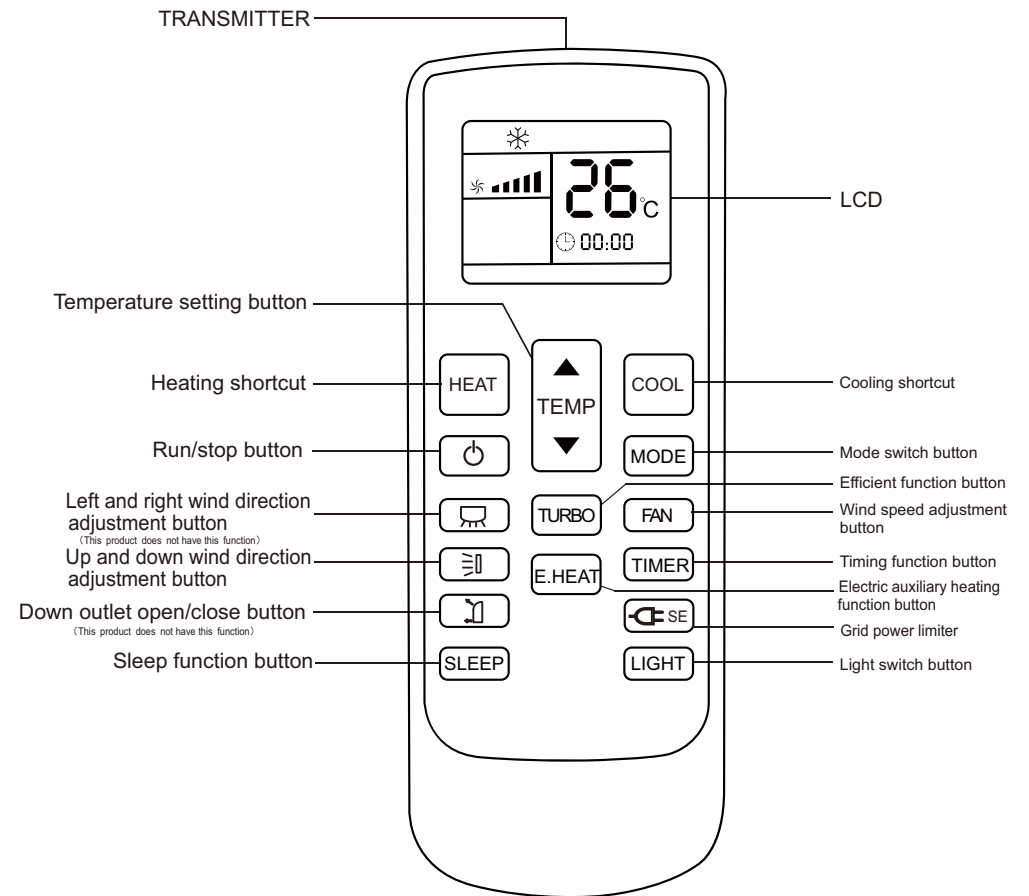

Basic operation of remote control

● "ⓘ" button	Press the "ⓘ" button to switch the air conditioner
● Mode selection	Press the "Mode" button and select the "Auto/Cooling/Dehumidifying/Air Supply/Heating" mode.
● Cooling	<p>This button is used to set the air conditioner to enter the cooling mode, and the set temperature is 26°Crun.</p> <ol style="list-style-type: none"> 1. When the air conditioner is on or off, just press the button, the air conditioner will enter coolingMode and set the temperature to 26°C. 2. In the timing on state, press this button to cancel the timing on setting and turn on in advance.Run cooling mode, set temperature to 26°C. 3. In sleep state, press this button to run the cooling mode, set the temperature to 26°C.
● Heating	<p>This button is used to set the air conditioner into heating mode, and set the temperature to 24°Crun.</p> <ol style="list-style-type: none"> 1. When it is turned on or off, as long as you press this button, the air conditioner will enter the heating modeAnd the set temperature is 24°C for operation. 2. In the timing on state, press this button to cancel the timing on setting and turn on in advance.Run heating mode, set temperature to 24°C 3. In sleep state, press this key to run heating mode, and set temperature to 24°C
● Temperature adjustment	<p>In cooling, heating, and dehumidification modes, press the "▲", "▼" keys to adjust the temperature degree, range 16-32°C Note: The temperature is not adjustable in the air supply mode.</p>
● Wind speed adjustment	<p>Press the "Wind Speed" button to select the wind speed of "Breeze/ Low Wind/Mid Low Wind/Stroke/High Wind/Auto". Note: There is no automatic wind speed in air supply mode.</p>
● One-click powersaving	<p>When connected to the mains, press the "⏻" button, the one-key power saving logo of the internal unit will turn green, and enterPower saving mode.</p>

★ Note on Adding Refrigerant

Some system require sddtional charging depending on pipe lengths ,The standard pipe length varies according to local regulations.For example ,in North America,the standard pipe length is 7.5m(25'),In other areas ,the standard pipe length is 5m(16').The additional refrigerant to be charged can be calculated using the following formul:

ADDITIONAL REFRIGERANT PER PIPE LENGTH

Connective Pipe Length(m)	Air purging Method	Additional Refrigerant	
≤Standara pipe length	Vacuum Pump	N/A	
>Standara pipe length	Vacuum Pump	Liquied side:φ6. 35 (φ0. 25 ") R22 : (Pipe length-standard length) x30g/m (Pipe length-standard length)x0.32oZ/ft Inverter R410A: (Pipe length-standard length) x15g/m (Pipe length-standard length)x0.16oZ/ft Fixed-frequency R410A: (Pipe length-standard length) x20g/m (Pipe length-standard length)x0.21oZ/ft	Liquied side:φ9. 52 (φ0. 375 ") R22 : (Pipe length-standard length) x60g/m (Pipe length-standard length)x0.64oZ/ft Inverter R410A: (Pipe length-standard length) x30g/m (Pipe length-standard length)x0.32oZ/ft Fixed-frequency R410A: (Pipe length-standard length) x40g/m (Pipe length-standard length)x0.42oZ/ft

4. Vacuum

★ Vacuum: Confirm that the indoor and outdoor connecting pipes have been tightened when vacuuming.

- 1.Unscrew the maintenance joint nut of the low pressure valve of the outdoor unit, and connect the composite pressure gauge to the maintenance joint of the stop valve;
- 2.Connect the vacuum pump to the composite pressure gauge, turn on the composite pressure gauge and the vacuum pump to vacuum the indoor unit and piping to make The absolute pressure after vacuuming is not higher than 50Pa;
- 3.Close the compound pressure gauge valve, stop the vacuum pump, and keep the pressure for 20 minutes without rising.

- When the outdoor unit is higher than the indoor unit, bend the pipe to ensure that the lowest point of the pipe is lower than the wall hole to prevent rainwater from flowing into the room or the indoor unit along the pipe.

3. Refrigerant pipe connection

★ Connection of piping and indoor unit

Remove the copper nut of the indoor unit, align the flared surface of one end of the connecting pipe with the pipe joint of the indoor unit, screw the copper nut onto the pipe joint of the indoor unit and tighten it (see the previous table for tightening torque).

★ Connection of piping and outdoor unit

1.Press the bell-shaped flaring of the piping against the connection heads of the low-pressure valve and the high-pressure valve, and the piping should keep the same axis direction as the connection head of the high and low pressure valve;

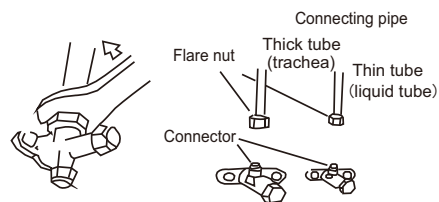

2.Gradually tighten the copper nut along the connector, and then tighten the nut.

Before putting the refrigerant in the outdoor system into the complete system, make sure that there is no impurities, moisture or non-condensable gas in the system. For this reason, vacuuming or emptying must be performed.

Piping specifications	Tightening torque	Flaring section processing size (A)	Flaring shape	Apply engine oil
φ 6.35/ φ 6mm	15-19N.m	8.3-8.7mm		
φ 9.52/ φ 9mm	35-40N.m	12.0-12.4mm		
φ 12.7/ φ 12mm	50-60N.m	15.4-15.8mm		
φ 15.88mm	62-76N.m	18.6-19.0mm		
φ 19.05mm	98-120N.m	22.9-23.3mm		

★ Note on Pipe length

The length of refrigerant piping will affect the performance and energy efficiency of the unit. Nominal efficiency is tested on units with a pipe length of 5 meters (16.5ft).

Refer to the table below for specifications on the maximum length and drop height of piping.

Maxing length and Drop Height of Refrigerant Piping per Unit Model

Model	Capatital (BTU/H)	Max.Length(m)	Max.Drop Height(m)
R410A Inverter Split Air Conditioner	< 15000	15	8
	≥ 15000 and < 20000	20	10
	≥ 20000 and < 30000	25	15

● Wind direction adjustment

Up and down wind direction adjustment:

When the air conditioner is running, press the "up and down wind" button, the up and down wind guide plate will start to swing, and then press this button to stop.

Left and right wind direction adjustment:

When the air conditioner is running, press the "left and right swing" button, the left and right wind guides will start to swing, and then press this button to stop.

Note: For some models, pressing the "left-right swing" button is invalid. Please manually move the left-right wind guide plate to the desired position.

● Powerful function

Press the "Power" button to enter the power running state, and the LCD screen wind speed display disappears.

1. The indoor fan runs at ultra-high speed under strong operation.
2. Press the wind speed, open/key to cancel the "power" function, mode change, sleep. The "Powerful" function will also be turned off.
3. In automatic, dehumidification, air supply mode, timing on, and sleep mode, pressing this key is invalid.

Note: The indoor unit may be louder when running strongly, which is a normal phenomenon.

● Good sleep

Press the "sleep" button to turn on the smart sleep mode (air conditioner wind speed and temperature automatically Adjust, the remote control display remains unchanged), it will automatically exit after 8 hours of continuous operation Sleep mode. Revert to the previous running state. Note: Sleep mode cannot be turned on in air supply mode; air conditioner in sleep mode. The display goes out.

● Timing setting

Press the "timing" button to set the scheduled shutdown when it is on, and press this button when off Set timed boot. Press the "timing" button to turn on the timing, press the "▲""▼" Set the time, the range is 1-24 hours, and then press the "timing" button to determine the timing time. If the timing has been set, press the "timing" button again to cancel the timing.

● Auxiliary heating function

This button sets or cancels the auxiliary electric heating function in heating mode. The initial state is on (the electric auxiliary heating is turned on by default when the heating mode is entered for the first time). Each time you press this key, it negates the previous one. Electric auxiliary heating can only be set in heating mode. When the mode is switched into heating and starting to enter heating and the conditions are met, electric auxiliary heating will be turned on automatically.

Note: some models have no electric auxiliary heating function

● Light

Press the "Light" button to control the on and off of the light on the air conditioner display.

1/ Download the "Solar Air Conditioner" app from Google Store or Apple Store by scanning the barcode below Sequence (IOS and Android). Register your phone number



2/ Turn on the power of the solar air conditioner, use the remote control, and press the "LIGHT" button within 10 seconds 8.Times or more. When you hear "Di", check that the Wi-Fi indicator flashes.

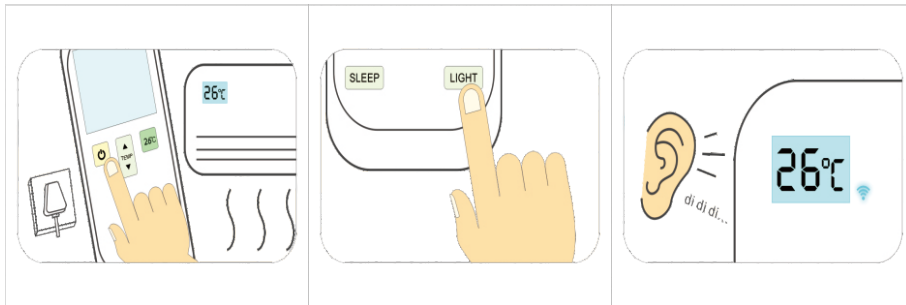

3. Turn on the Bluetooth of the mobile phone and connect to the home wi-fi.

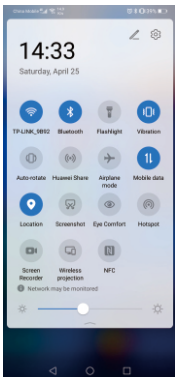

Piping installation

1.installation steps:

1. Welding of piping (if welding is required when using extended piping).
 - ①Please perform piping before tightening the flared nut. ②When welding, nitrogen must be blown (this can prevent the oxidation layer inside the copper pipe).
2. Please blow with nitrogen or air before connection to remove the dust in the tube.
3. Please set the pipeline according to the direction of the pipeline, but do not repeat the operation of bending and straightening at the same position for more than 3 times.(This will harden the tube).
4. After the piping is bent, align the center of the joint (piping interface) of the indoor unit and the center of the piping, and tighten it firmly with a two-handed wrench. (Before tightening the flared nut, please apply a thin layer of refrigerating oil on the inner and outer sides of the flared part) For the tightening torque of the flared nut and the skill of using the double wrench, please refer to the figure and table below. If the nut is tightened Too tight, the flared nut will break and cause leakage.
5. Connect to the piping interface on the outdoor unit.
6. After the piping is connected, it must be confirmed whether there is refrigerant leakage at the indoor and outdoor joints, and insulation measures must be adopted.

2. Thermal insulation package, strong hole sealing

	NOTE : The drain pipe and piping must be insulated with insulation materials separately, otherwise condensation or water leakage will occur
--	--

Use heat-insulating materials with good heat-insulating properties (heat-resistant 120°C or higher) to heat-insulate the pipes

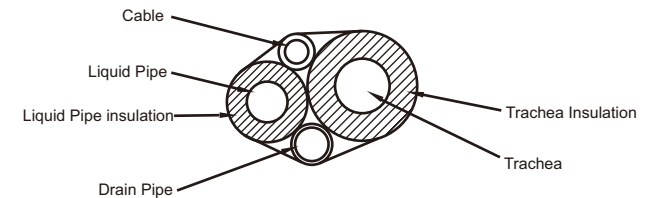

2. Sealing of wall holes:

- After the piping and drain pipes are installed, seal the gaps between the wall holes and the piping, drain pipes, and wires with glue or putty to prevent rain or foreign objects from entering the room and indoor unit, otherwise it will cause a decrease in capacity or water leakage.

2. Outdoor unit installation

1. Arrange drainage channels to ensure the smooth discharge of condensate;
2. The strength and level of the foundation should be checked when implementing scheduled operations to avoid vibration and noise;
3. Fix the outdoor unit firmly with foundation bolts;
4. The appropriate length of the foundation bolt is 20mm beyond the surface of the foundation; 5. The foundation should avoid a shape with only four corners to support the outdoor unit.

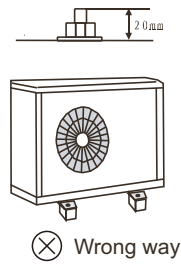

Note Pay special attention to arranging drainage channels around the foundation to drain the condensate. When installing on the roof, pay special attention to the strength of the floor and take waterproof measures.

3. Condensate drain

During the heating operation of the air conditioner, the condensed water formed by the outdoor unit and the defrosting water generated during defrosting can be drained to a suitable place through the drain pipe. Installation method: Clip the water outlet into the hole of the chassis as shown in the figure, and then connect the drain pipe to the water outlet to lead the condensate and defrosting water to a proper place for discharge.

Note: Water pipes are not required in northern areas.

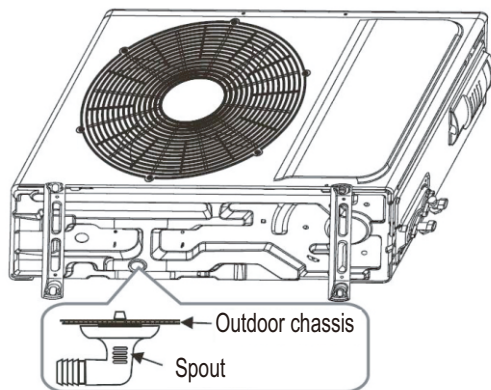

4/ Open the application, click Add device, the application will automatically get our solar AC equipment. Confirm the device, enter the home or office WiFi password, and then start the connection. See the figure below.

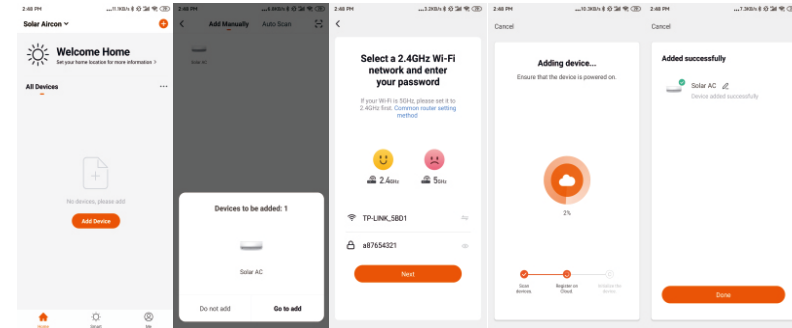

5/ Use App to control the air conditioner anywhere via WIFI. Check the power saving data and power by hour/day/month/year.

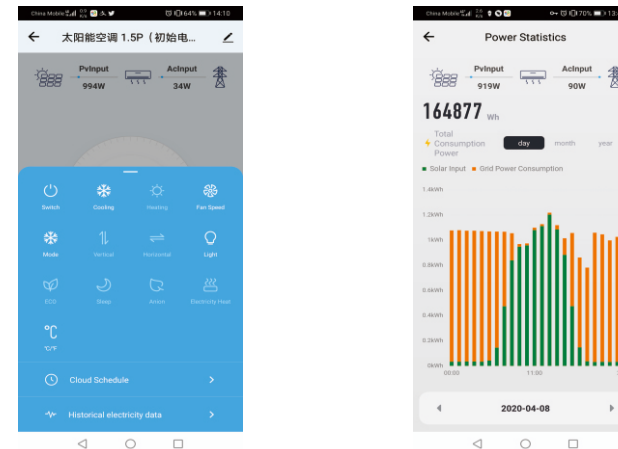

note:

Application control is applied to the model with WiFi function
Mark: App power data is for reference only.

Air conditioner installation

1. on grid air conditioning unit (ACDCBLW) installation diagram

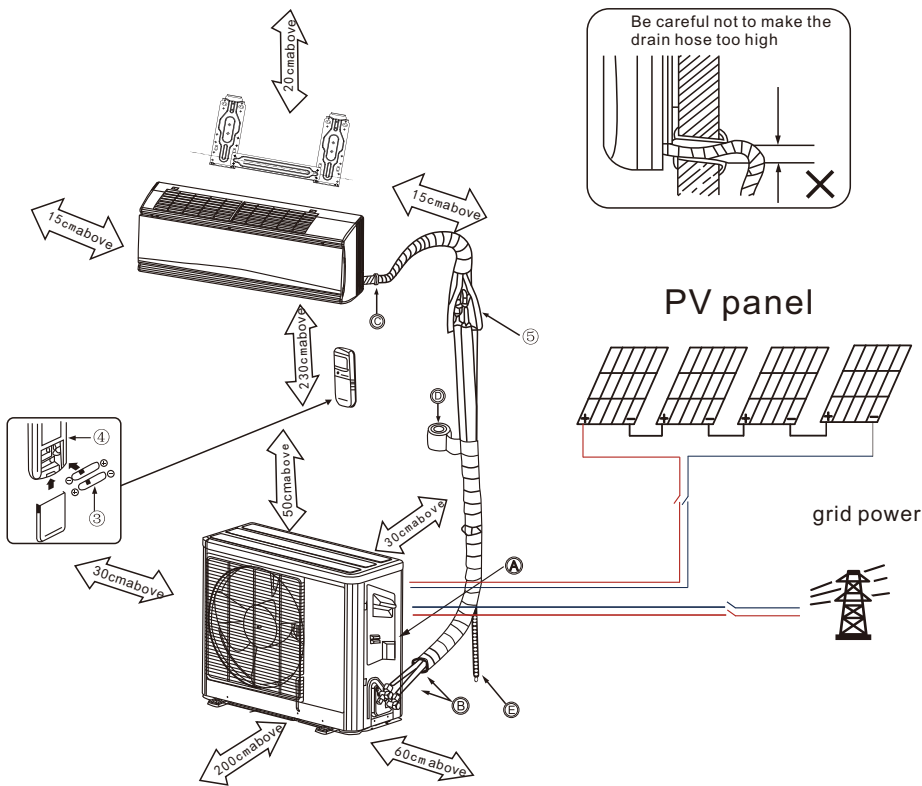

The unit must be installed for you by a professional who holds an installation certificate in accordance with local regulations

★Due to higher condensing temperature (refrigeration) or lower evaporation temperature (heating), it will affect the operation of the outdoor unit, in order to achieve the maximum. For energy efficiency, the selection of installation location must follow the following principles:

1. The air exhausted from the outdoor unit will not flow back to prevent short circuit of the exhaust, and leave enough maintenance space around;
2. The inclination angle is strictly prohibited to exceed 5 degrees.

★ The correct and wrong practices are shown in the figure below:

Wrong way	Correct way

★Tilt the drain hose downward, not as shown in the figure below.

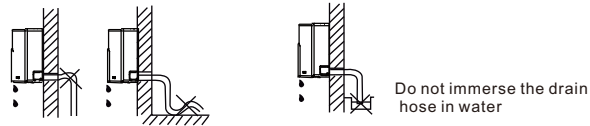

- ★When connecting the extended drain hose, the connection part of the drain hose should be isolated from the shielding pipe, and the drain hose should not be loosened.
- ★The connection of the drain hose should be completed by qualified installers to prevent water leakage.
- ★Bundle the pipe, connecting cable and drain hose firmly and evenly with tape, as shown in the figure below.
- ★In the indoor part of the drain pipe, heat insulation materials should be added, otherwise condensation water may occur.

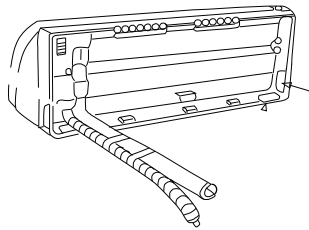

Outdoor unit installation

1.outdoor unit installation location selection

Attention	1The installation point must be well ventilated so that the machine can inhale and exhaust enough air; 2The installation place is sufficient to bear the weight of the outdoor unit, and can isolate noise and vibration; 3Avoid direct sunlight, if necessary, it is better to support a sunshade; 4The installation place must be able to exclude rainwater and defrosting water; 5The installation place must ensure that the machine will not be buried in snow; 6The installation place must ensure that the air outlet will not face the strong wind; 7Ensure that the wind and operating noise of the unit will not affect neighbors; 8The installation location must not be affected by garbage and oil mist.
Caveat	If the outdoor unit is operated in an atmospheric environment containing oil sources (including engine oil), salt (in the ocean area), and sulfide gas (in hot springs or near oil refineries), these substances may cause the unit to malfunction.

Air conditioner installation

1. off grid air conditioning unit (DC48V) installation diagram

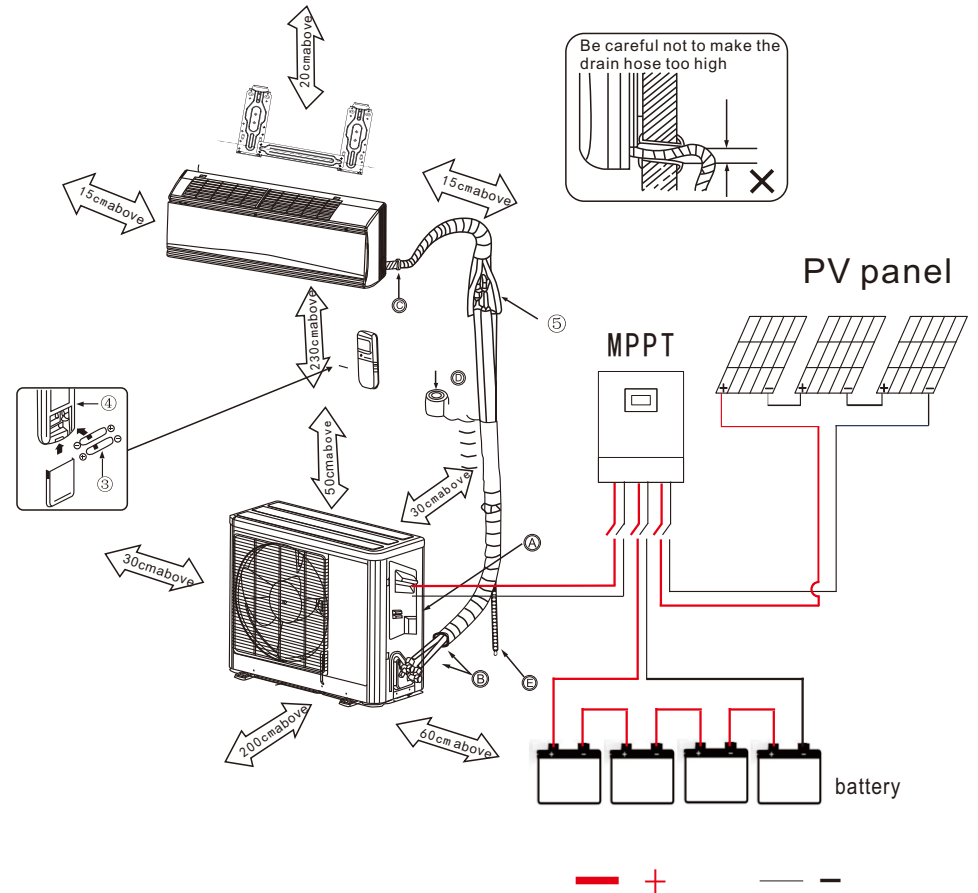

The unit must be installed for you by a professional who holds an installation certificate in accordance with local regulations

indoor unit installation

1. indoor unit installation location selection

※ Select a location that meets the following conditions and obtain the customer's approval for installation.

1. There are no obstacles that hinder the air circulation nearby, and the airflow evenly spreads to all corners of the room.
2. Ensure that the indoor unit installation meets the requirements of the installation dimension drawing.
3. The installation place should be easy to drain.



4. The position of the hanger should be able to support more than 4 times the weight of the indoor unit, and there should be no increase in noise and vibration. If reinforcement is needed, it should be reinforced before installation (If the reinforcement is insufficient, the indoor unit will fall and cause injury.)

5. There should be no heat and steam sources nearby.
6. Places close to the power source (dedicated circuit).
7. A place where it is easy to connect to the outdoor unit.
8. Avoid places exposed to direct sunlight and excessive humidity.
9. Do not install in the laundry room (it may cause electric shock).

■ Note 1

★ Fully check the following places before installation.

1. Fume, steam, flour, etc. in restaurants, kitchens and other places can easily adhere to turbofans, heat exchangers, and drain pumps, reducing the heat exchange effect, causing sprays, water droplets, or causing poor operation of the drain pump.
2. When installing air conditioners in factories and other places, avoid places where the air is filled with cutting oil, cutting powder, and iron filings.
3. Avoid places where flammable gas stays and leaks.
4. Avoid places where sulfurous acid gas and corrosive gas are generated.

■ Note 2

★ To avoid malfunctions, do not drop the indoor unit when moving it.

2. Indoor unit installation

(1) . Fixed mounting plate

- Choose the installation location (the installation wall must be firm), remove the wall-mounted panel on the back of the indoor unit, and place the wall-mounted panel on the pre-selected installation location, leaving enough distance from the ceiling and left and right walls, and use a level to ensure horizontal installation .

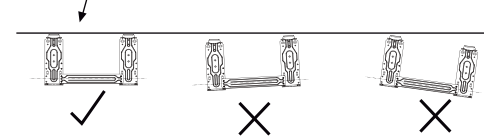

- Fix the wall panel to the wall with nails. As far as possible, choose the position of the fixed nail to bear the weight on both sides of the wall panel.
- use your hand to pull the wall panel to ensure a firm fixation.

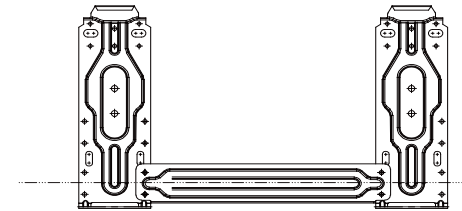

Note:

1. The wall panel graphics are for reference only, and may be different from the actual product, please refer to the actual product.
2. Taking into account the specific situation of the fixed wall, the site can be based on the actual. The situation determines the position of the fixing hole, and the final installation shall prevail.

(2) . Connect pipes and drains

★ Schematic diagram of wall pipe installation

1. After determining the position of the pipe hole, drill an outwardly inclined hole.
2. In order to protect the piping and cables through the wall holes from damage, and to avoid rodent damage in the hollow wall, wall pipes must be installed. Indoor/outdoor The side wall holes are sealed with sealing glue.
3. The highest position of the wall hole cannot exceed the bottom surface of the air conditioner. If the height of the wall hole does not meet the requirements, the hole must be re-opened to prevent the product from leaking.

