

AMC16(L)-DETT DC power meter module of base station

Installation and operation manual V1.6

Declaration

All rights reserved. Without the written permission of the company, the contents of any paragraphs and chapters in this manual shall not be copied, copied or reproduced or disseminated in any form. Otherwise, all consequences shall be borne by the violator.

The company reserves all legal rights.

The company reserves the right to modify the specifications described in this manual without prior notice. Before ordering, please consult your local agent for new specifications.

CONTENTS

1 Overview.....	1
2 Product model.....	1
3 Technical parameters.....	1
4 Outline structure.....	2
5 Installation wiring.....	3
5.1 terminals and wiring.....	3
5.2 wiring precautions.....	3
6 Guide to use.....	4
6.1 Panel diagram.....	4
6.2 LED instructions.....	4
6.3 AMC16L-DETT key operation.....	4
6.4 AMC16L-DETT operation display instructions.....	5
7 Communication guide.....	6
8 Hall densor recommended.....	9

1 Overview

AMC16(L)-DETT is specially designed for base stations where have sharing requirements, and switch power supply is without the function of sub-user metering. The meter could measure 6 circuits DC energy, and supply working current to the matched hall sensors. Meanwhile, it can realize zero drift calibration by upper computer software. have the functions of telemetering,teleindication,teleadjusting, metering at real time, energy quality abnormal alarm, data storage and processing, data interaction. The module can measure the DC power consumption of multiple circuits separately, providing detail datas for base station.

2 Product model

Name	Model	Instruction	Note
6 Channels DC Energy Meter	AMC16(L)-DETT	35mm din rail	L:with liquid crystal; AI:4-20mA input

Note: 4-20mA transmitter input only support model: AMC16-DETT/AI

3 Technical parameters

Technical parameter		Index
input	DC rated voltage	1 channel: -48VDC
	DC current	6 channels hall sensors output is 5V,current ratio can be set according to the actual ratio
	Commercial power monitoring	1 channel transmitter input: 0-5VDC or 4-20mA
	Overload capacity	Voltage:1.2times continued,2 times continued 1s; Current: 1.2 times continued,10 times continued 1s.
Accuracy (superposition hall sensors)		1%In≤I≤10%In accuracy ±2.5%; I>10%In accuracy ±2%
Measurement resolution		Voltage output accuracy 0.01V; current output accuracy 0.01A; power output accuracy 0.01kw; energy output accuracy 0.01kWh.
functions	Basic function	Monitor device system time, total voltage, output total current, power, energy, each channel voltage, current, power, energy; LED indicator display;485 communication.
	Metering function	Start current: under rated voltage, when the load current value of the meter doesn't exceed 1% of the max. current, the meter starts. Shunt running current: when there is no current in the current circuit of the meter, and 85%-125%of the rated voltage is applied on the voltage circuit, the calculator shall not have more than one digital change.
	Alarm function	DC voltage output low alarm,DC voltage output high alarm,one power down alarm, module voltage loss alarm, metering branch error alarm, internal program error alarm, clock error alarm,memory failure alarm, AC input power failure alarm
	Timing function	support broadcast timing, could remote timing to the meter through RS485 communication.
	Communication	Single channel RS485, baudrate 9600bps, can be set to 1200BPS, 2400bps, 4800bps. Communication protocol: standard or custmized

	Hall sensor power supply	Power supply output:+12V/100mA, -12V/50mA
	Clock accuracy	≤0.5S/d(23°C), ≤1S/d(-20°C-60°C),
Auxiliary power supply	Voltage range	-40V~-60VDC
	Power consumption	Whole device≤2W(no hall power supply output)
Storage		It has the storage function of historical power data and historical alarm information, and the memory is 2MB
Insulation resistance		≥40MΩ
environment	Temperature	Working : -20°C~+60°C; storage:-40°C~+70°C
	Humidity	≤98% no condensation, no corrosive gas place
	Altitude	≤4000m
Protection level		IP20
Material flame retardant		Terminal glow wire temperature 960°C±10°C ,shell glow wire temperature 650°C±15°C
installation		Standard 35mm din rail

4 Outline structure

AMC16(L)-DETT

unit: mm

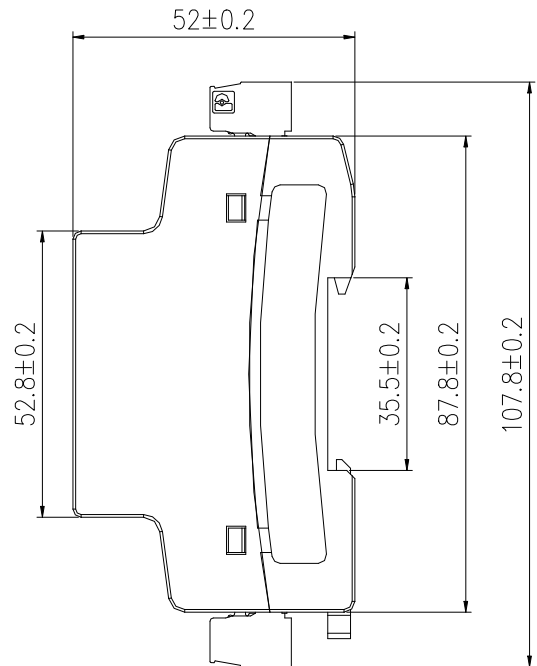
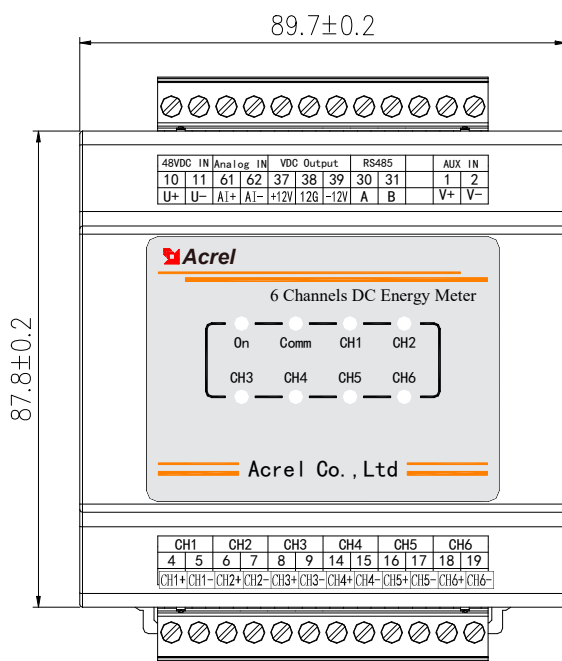

5 Installation wiring

5.1 terminals and wiring

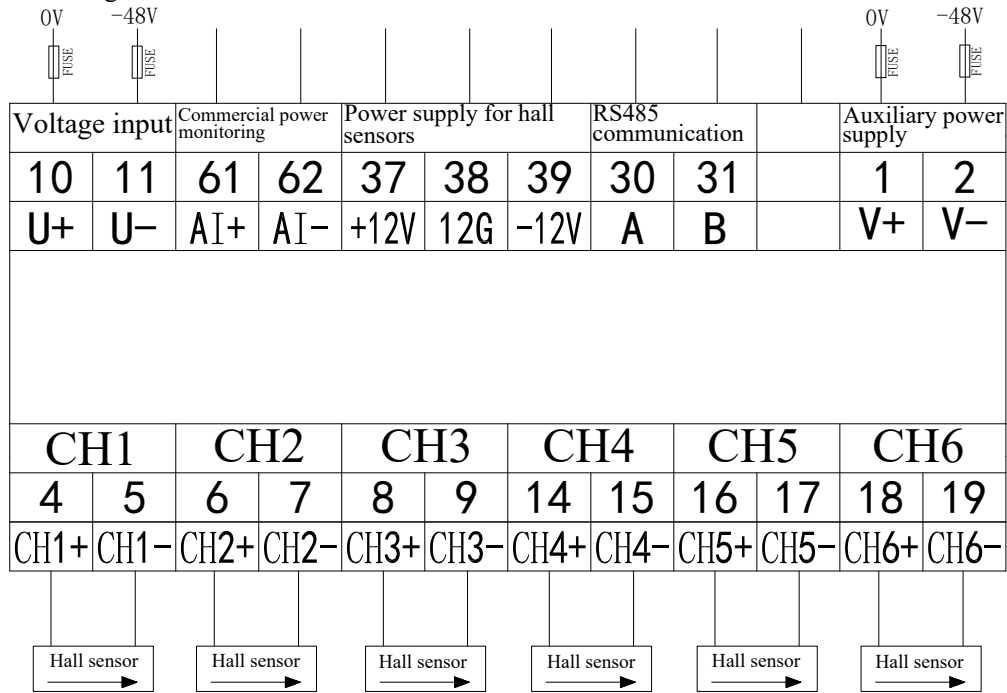

Note: arrow direction should be the same with current direction marked on the sensor . 

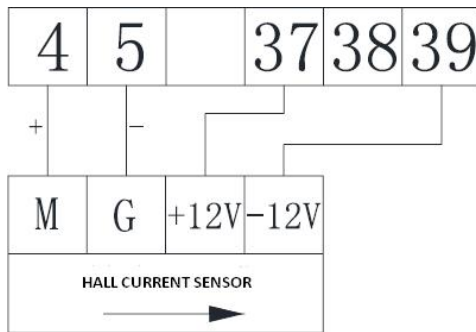

HALL SENSORS WITH ISOLATION FUNCTION WIRING

5.2 wiring precautions

- 1)input voltage should not be higher than 120% of product's rated input voltage, must install 1A fuse at the voltage input terminal.
- 2)Current input should use external diverter or hall sensor.
- 3)To ensure the accuracy,the DC meter should used together with Acrel hall sensors, the wiring length between sensors to meters should <3m.
- 4)Advise use three core shielded wires as communication connection wires. Each core >0.5mm² connect A,B, Connect shielding layer to earth, and keep communication line away from strong electric cable or other strong electric field environment during wiring
- 5)The hall sensor opening locking screw must be tightened to ensure the closed-loop tightness of the sensor.
- 6)When model is AMC16-DETT/AI: 61 AI+,62 AI-input signal is 4-20mA.
- 7)Please keep the wiring between the instrument and hall sensor correct, otherwise the instrument and hall sensor will be damaged.

6 Guide to use
6.1 Panel diagram

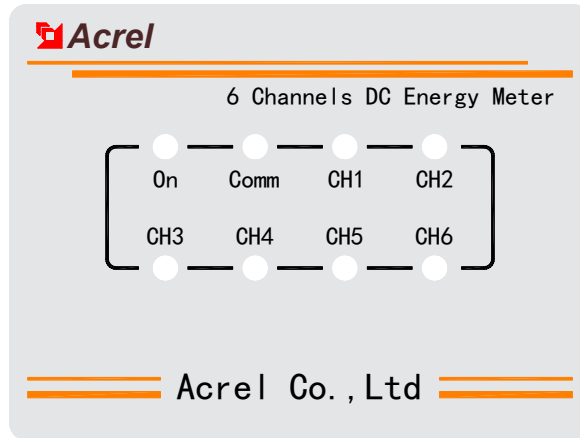

AMC16-DETT

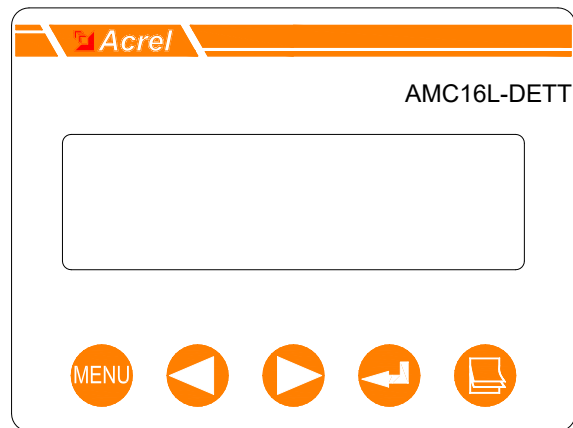

AMC16L-DETT

6.2 LED instructions



A total of 8 LED indicators are used to indicate the working status of the metering modules;

“running” status (green) : when the metering module is in normal operation,the running indicator light flashes。





“ communication ” status (red) : when the 485 communication of metering module is normal,the communication indicator will flash.

“CH1”、“CH2”、“CH3”、“CH4”、“CH5”、“CH6”status (red) :the corresponding indicator lights flash when the corresponding circuit power metering monitoring.

6.3 AMC16L-DETT key operation

There are five buttons in the AMC16L-DETT, from left to right:  menu key、 left key、 right key、

 enter key和  page key

 menu key	Non programming mode: press this key to enter the programming mode,and the device will prompt you to enter the password or return to the previous menu. Programming mode: used to return to the previous menu or exit the Programming mode.
 left key、  right key	Non programming mode: used to switch the display interface; Programming mode: used to switch the same level menu and shift the cursor.
 enter key	Programming mode: used to confirm the selection of menu items and enter the next level menu.
 page key	Non programming mode: used to increase the number of digits. Programming mode: used for 6-way metering shunt page turning.

6.4 AMC16L-DETT operation display instructions

After the instrument is powered on, the screen displays the power on interface as follows:whether there is signal input in 6 current metering channels CH1-CH6 and the real time data of correspond voltage and current of each channel.The value under the black shadow in the upper right corner indicates the current channels.press the page turning key to increase the number of channels,up to 6.Then press the left and right keys to switch back and forth the interface of voltage,current,power,electric energy,total electric energy,mains power and display time.On the power on interface,Press the menu key to enter the password input interface.After entering the password,you will enter the menu setting interface:1.communication,2.time,3.power,4.system.press the left and right keys to move the cursor,and press enter to enter each sub interface for viewing.the specific flow chart is as follows.

Power on interface

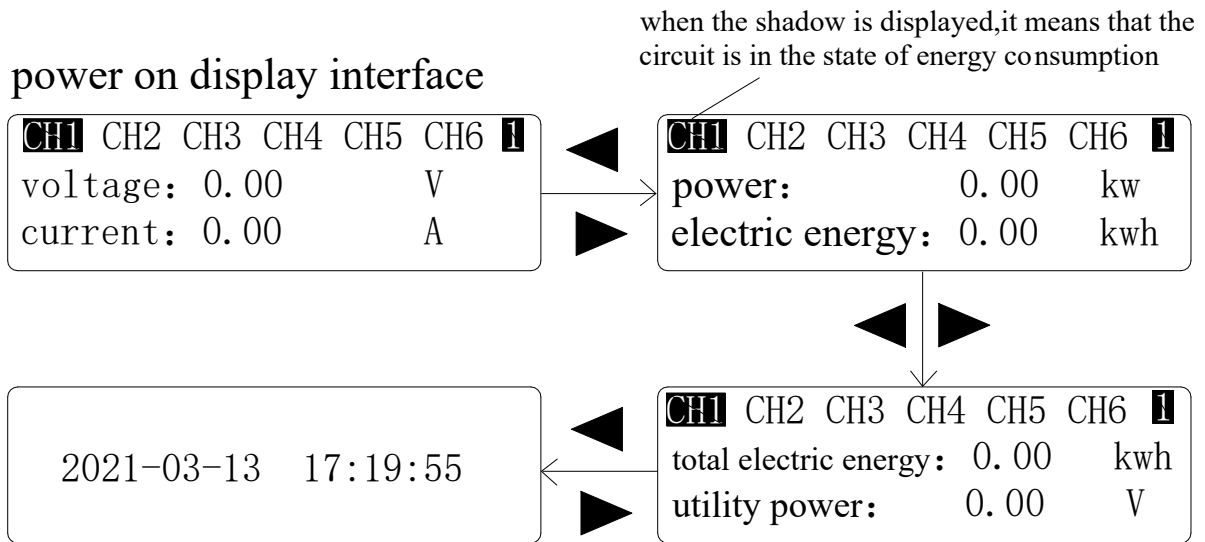

AMC16-DETT and AMC16L-DETT has six metering branches.By default,the first channel is the total metering,the second,third and fourth channels are mobile users,unicom users and telecom users respectively,and the fifth and sixth channels are reserved.

When the first circuit current is connected,white words on black background will be displayed at I1,indicating that the circuit is in energy consumption state,and the rest circuits are the same.It can display single current connection or multiple current connection.

When connecting communication,the communication icon will appear in the lower right corner of the interface to distinguish.The specific display is shown in the figure below.

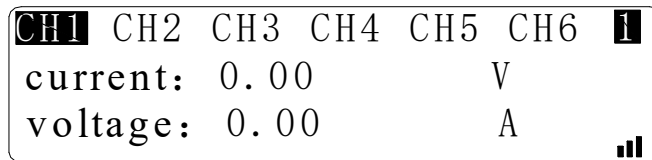

Menu function option interface

Press the menu key to enter the password interface.The default password is 1.Press left and right keys to shift,press the page turning key to increase the value,and then press the enter key to return to the power on interface.

Menu function setting interface

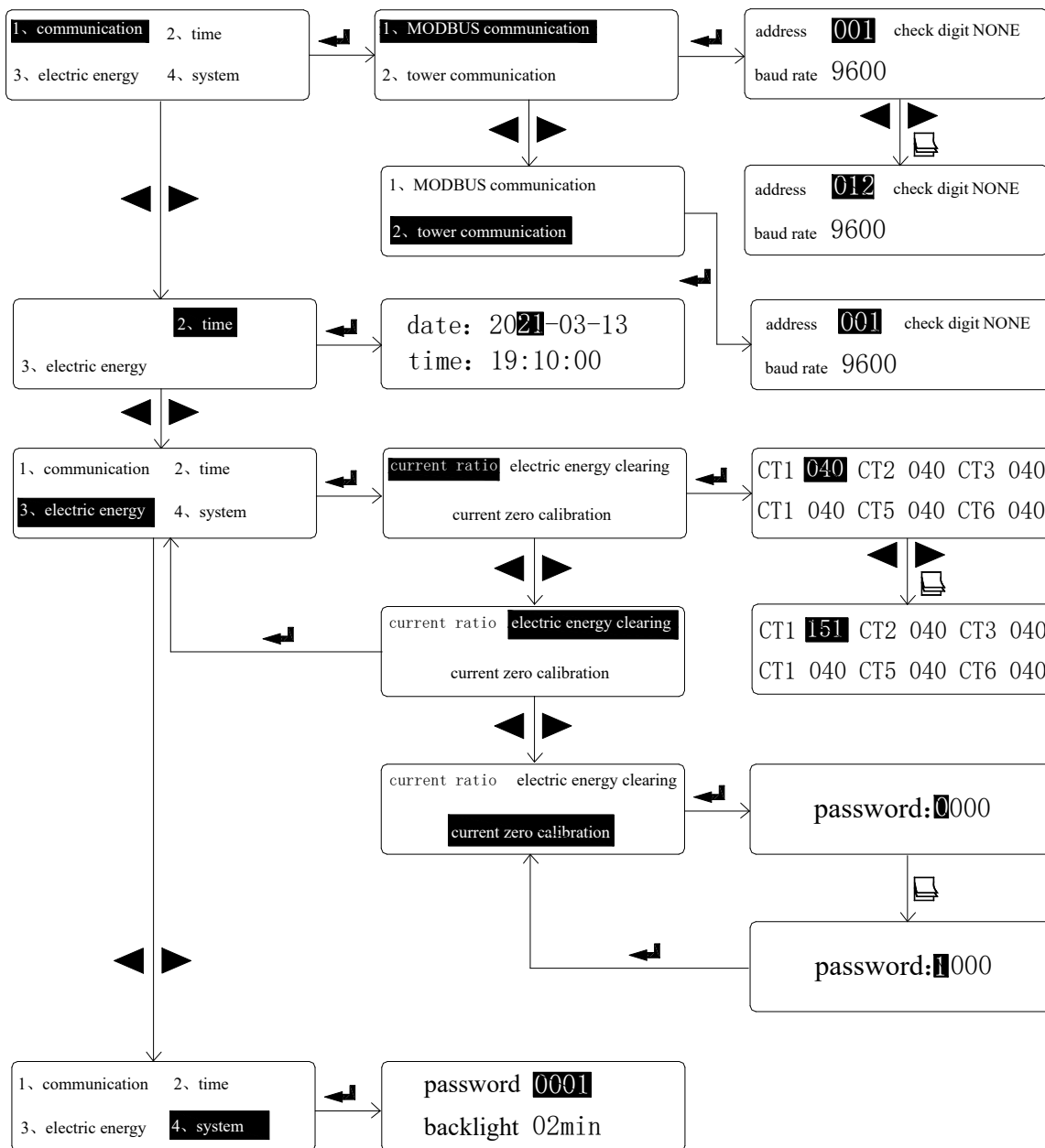
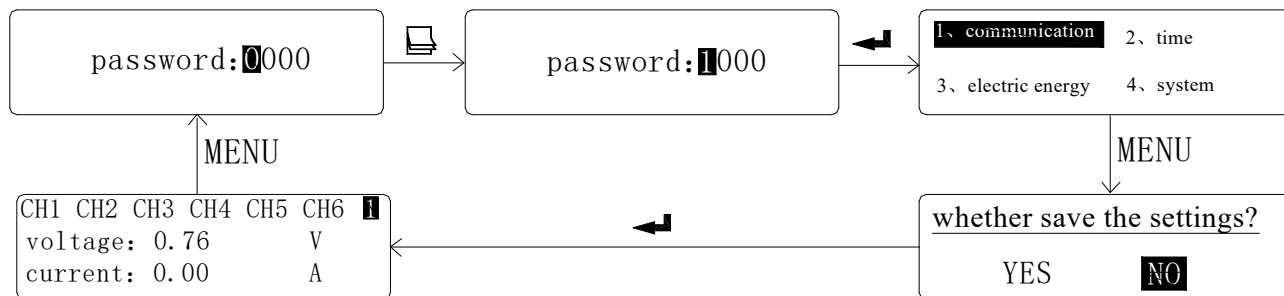

CT1-CT6 in the current ratio interface indicates the corresponding transformation ratio of each circuit in the factory. The default value is 40, and the corresponding rating is $5 \times 40 = 200A$. The parameters can be adjusted through the page turning key, and the maximum value can be set to 999.

7 Communication guide

- Modbus address table
- Telemetry, telecontrol

Parameter area

Address (decimal)	Address (hexadecimal)	Variable	Read/write	Length	Note	Data type
0	0x00	address	R/W	2	1-247	Uint16
1	0x01	Baud rate	R/W	2	2400 4800 9600 19200	Uint16
2	0x02	reserve	R	2		Uint16
3	0x03	reserve	R	2		Uint16
4	0x04	voltage ratio	R/W	2		Uint16
5	0x05	voltage ratio 1	R/W	2		Uint16
6	0x06	Current ratio 2	R/W	2		Uint16
7	0x07	Current ratio 3	R/W	2		Uint16
8	0x08	Current ratio 4	R/W	2		Uint16
9	0x09	Current ratio 5	R/W	2		Uint16
10	0x0A	Current ratio 6	R/W	2		Uint16
11	0x0B	Zero shielding value setting	R/W	2	One decimal place	Uint16
12	0x0C	Current zero calibration	R/W	2	0x8801:the first way 0x8802:the second way 0x88FF:whole	Uint16
13	0x0D	Electric energy clearing	R/W	2	0x8801:the first way 0x8802:the first way 0x88FF:whole	Uint16
14	0x0E	AI high point	R/W	2	AMC16-DETT/AI exclusive	Uint16
15	0x0F	AI low point	R/W	2		Uint16
16	0x10	reserve	R	2		Uint16
17	0x11	reserve	R	2		Uint16
18	0x12	reserve	R	2		Uint16
19	0x13	language	R/W	2	(0 Chinese, 1English)/AMC16L-DETT exclusive	Uint16
20	0x14	reserve	R	2		Uint16
21	0x15	backlight	R/W	2	0-5 (min) /AMC16L-DETT exclusive	Uint16
22	0x16	secret	R/W	2	0-9999/AMC16L-DETT exclusive	Uint16
23	0x17	reserve	R	2		Uint16
24	0x18	Instrument serial number	R/W	2*7	AMC16L-DETT support	ASCII
25	0x19					
26	0x1A					
27	0x1B					
28	0x1C					
29	0x1D					
30	0x1E					

Electric parameter data area

Address (decimal)	Address (hexadecimal)	Variable	Read/write	Length	Unit	Note	Data type
48	0x30	Voltage 1	R	4	V		Float
49	0x31						
50	0x32	Voltage 2	R	4	V		Float
51	0x33						
52	0x34	Voltage 3	R	4	V		Float

53	0x35						
54	0x36	Voltage 4	R	4	V		Float
55	0x37						
56	0x38	Voltage 5	R	4	V		Float
57	0x39						
58	0x3A	Voltage 6	R	4	V		Float
59	0x3B						
60	0x3C	Current 1	R	4	A		Float
61	0x3D						
62	0x3E	Current 2	R	4	A		Float
63	0x3F						
64	0x40	Current 3	R	4	A		Float
65	0x41						
66	0x42	Current 4	R	4	A		Float
67	0x43						
68	0x44	Current 5	R	4	A		Float
69	0x45						
70	0x46	Current 6	R	4	A		Float
71	0x47						
72	0x48	Power 1	R	4	W		Float
73	0x49						
74	0x4A	Power 2	R	4	W		Float
75	0x4B						
76	0x4C	Power 3	R	4	W		Float
77	0x4D						
78	0x4E	Power 4	R	4	W		Float
79	0x4F						
80	0x50	Power 5	R	4	W		Float
81	0x51						
82	0x52	Power 6	R	4	W		Float
83	0x53						
84	0x54	Energy 1	R	4	0.01kWh		Uint32
85	0x55						
86	0x56	Energy 2	R	4	0.01kWh		Uint32
87	0x57						
88	0x58	Energy 3	R	4	0.01kWh		Uint32
89	0x59						
90	0x5A	Energy 4	R	4	0.01kWh		Uint32
91	0x5B						
92	0x5C	Energy 5	R	4	0.01kWh		Uint32
93	0x5D						
94	0x5E	Energy 6	R	4	0.01kWh		Uint32
95	0x5F						
96	0x60	AI display value	R	4	/	AMC16(L)-DETT display voltage value(0-5V) AMC16-DETT/AI display current corresponding value	Float
97	0x61						

8 Hall densor recommended

Recommend hall sensor

(unit: mm)

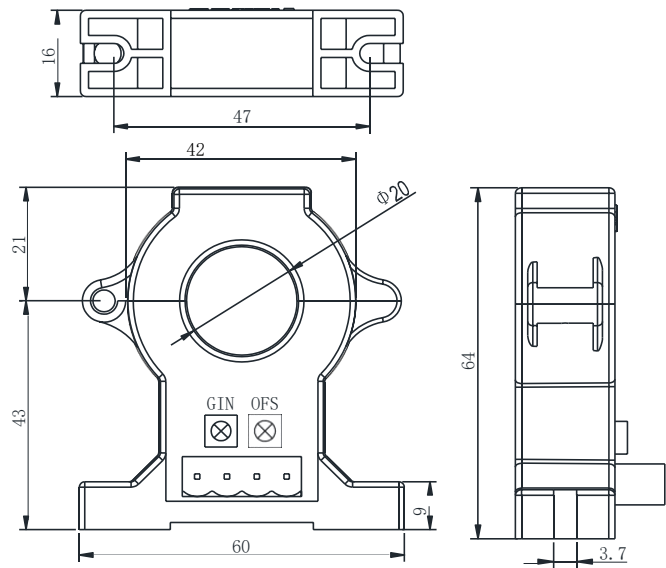

AHKC-EKA (50A/5V) aperture $\Phi 20$ mm

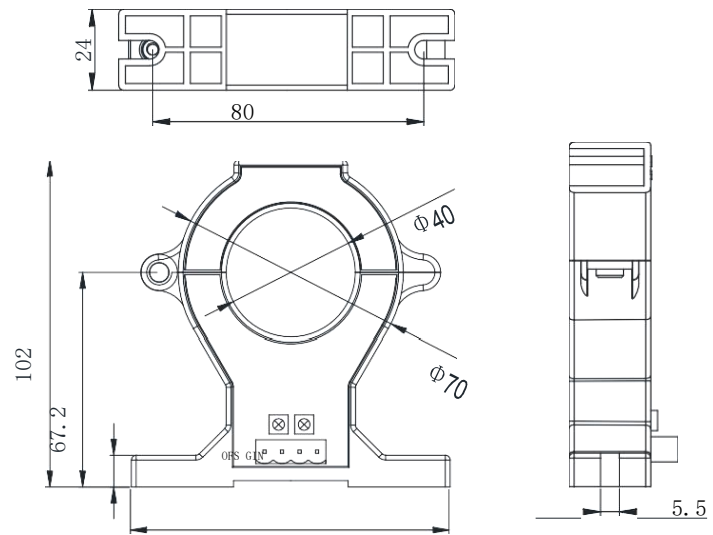

AHKC-EKB (100A/5V) aperture $\Phi 40$ mm

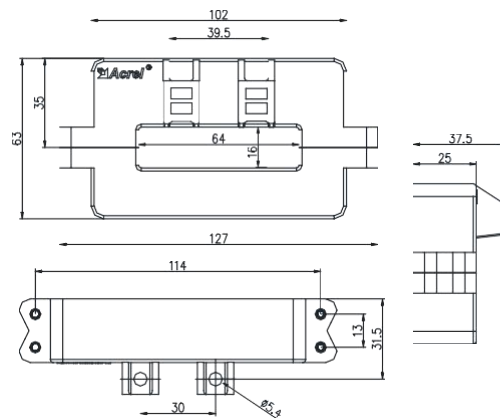

AHKC-K (200A/5V) aperture $\Phi 64 \times 16$ mm