

# SW9 SHOCKWAVE SYSTEM

VER:1.0

## USER MANUAL



---

## Warning

Dear user:

Thanks for using our company's products, in order to fully make use of the products, we sincerely suggests follow:

- ◆◆ Please read the instruction in detail and keep it well for further reading and consulting.
- ◆◆ Please follow the instruction to fit and operate the machine correctly.
- ◆◆ Please do not remove and change any accessories of the machine.
- ◆◆ It forbids others to open and remove the mainframe except the authorized people in the company.
- ◆◆ It forbids others to change and maintain the machine except the professional people.
- ◆◆ Please contact us if there is any trouble during operation.

**This product does not belong to medical, please don't use for disease treatment!**

## Parts Introduction

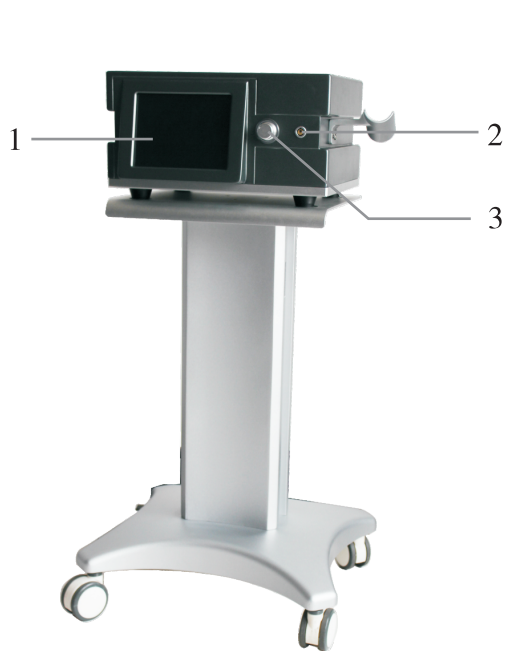

- 1.Touch screen
- 2.Shockwave work handle jack
- 3.Function selecting knob & Confirming button
- 4.Accessory frame

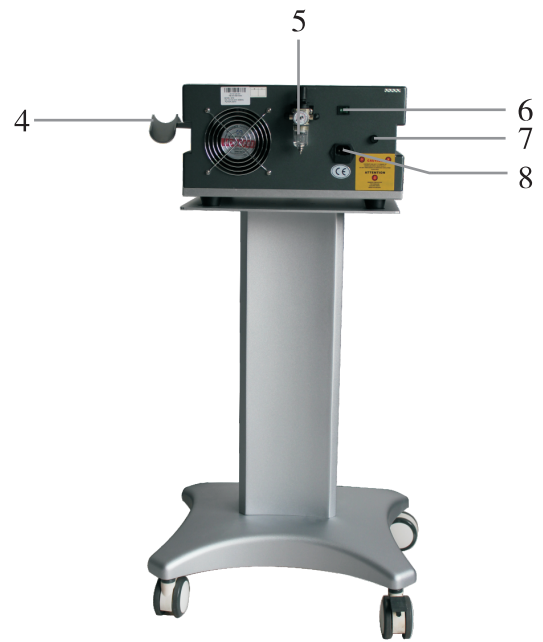

- 5.Filter cup with pressure gauge
- 6.General power switch
- 7.Fuse holder
- 8.Power supply line switch

## Accessories

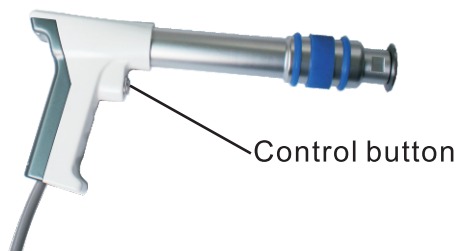

Shockwave work handle



Screw cap

1# Adapter



2# Adapter



3# Adapter



**Any part of instrument made of PMMA material (for example: accessories shelf, panel, transparent handles, etc.). Do not use alcohol or corrosive solvent to wipe clean.**

## Replace Adapter

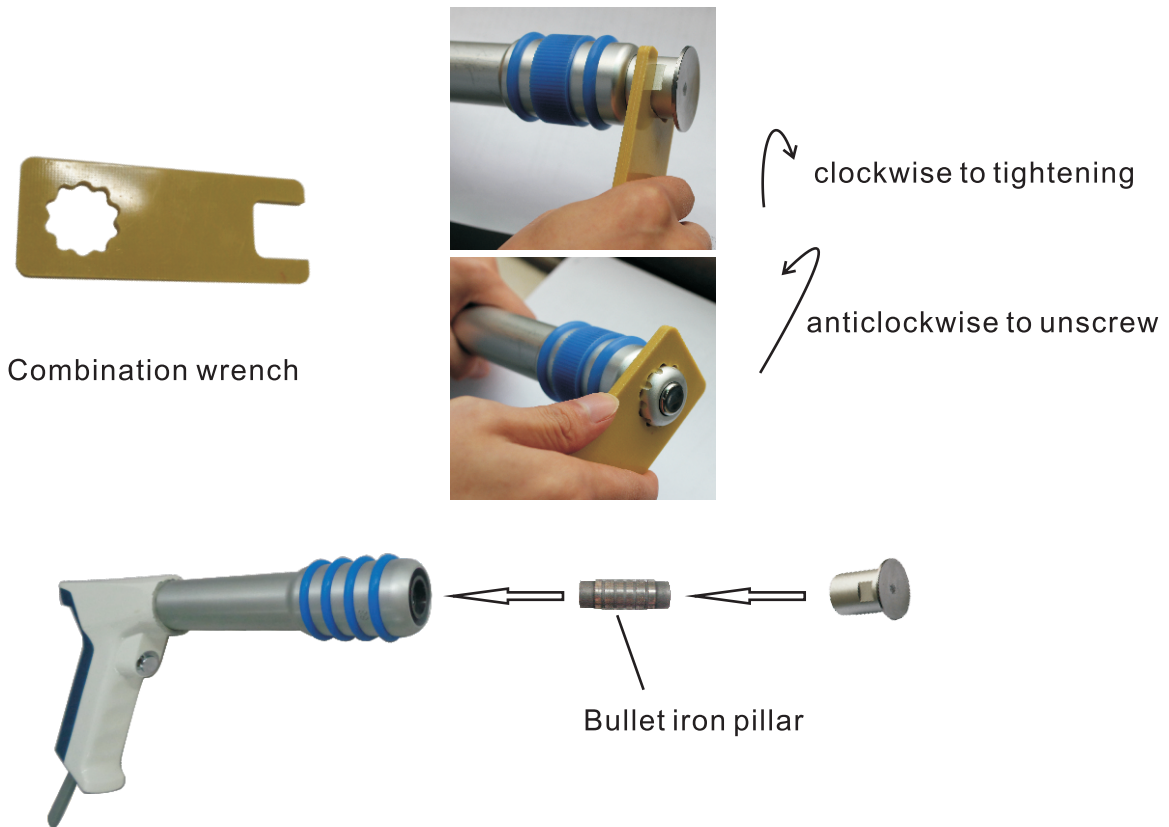
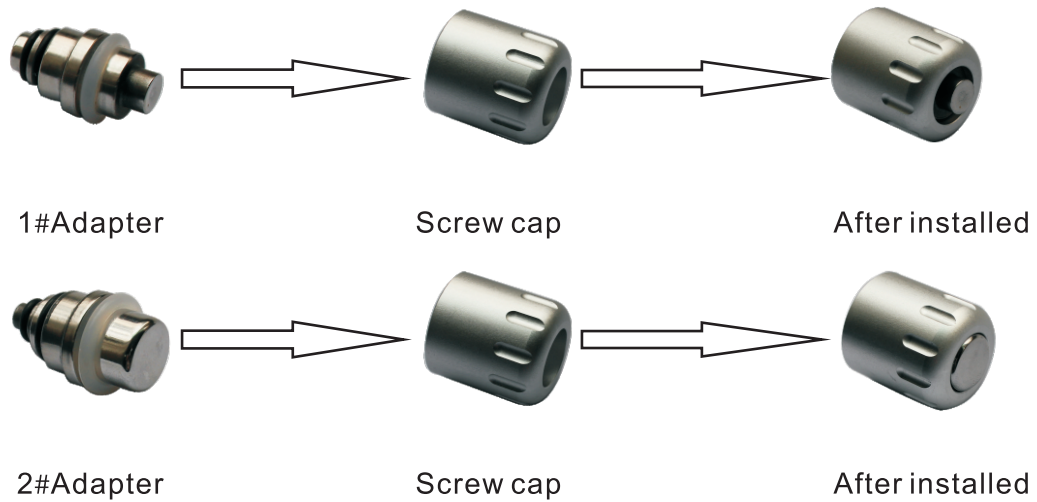

1. if you need to change adapters during operating, one hand hold the shockwave hand, the other hand use "U" shaped of combination wrench to get stuck flat bit of 3# adapter, screw it out by turning it to anticlockwise.
2. Choose 1# or 2# adapter, put it into screw cap, and then install then into shockwave handle. tighten by turning them to clockwise. Then use the "O" shaped wrench to fasten the adapter. Change adapter is finished.
3. When the number of times to reach 2 million, you need to replace the bullet iron pillar. Remove the screw cap, and take out the old one. Then put into a new one and installed the adapter.



---

---

## General Introduction

The shockwave system uses the ballistic principle of shockwave generation: A pressure wave is formed via a projectile by using accelerated compressed air. The compressed air is generated by an electronically-controlled ballistic-pressure compressor. Using elastic impact, the kinetic energy of the projectile is transferred into the probe of the applicator and then into the client's body. Consequently, during the treatment, the end of the applicator must be in direct-contact with the skin and subcutaneous tissue.

Shockwave is aimed at the affected areas that are the source of chronic pain. The influence of the shockwaves causes to the dissolution of calcium deposits and leads to better vascularization. The after-effect is relief from the pain.

Shockwave has the following effects:

- Cellular: Increase in cell membrane transmittance by improving ionic channels activity, stimulation of cell division, stimulation of cellular cytokines production.
- Reproduction of vessels in the area of tendons and muscles: Improvement of blood circulation, increase in concentration of growth factor beta 1 , chemotactic and mitogenic effect on osteoblasts.
- Effect on nitrogen oxide system: Bone healing and remodelling.
- Improvement of micro-circulation and metabolism.
- Dissolution of calcified fibroblasts.
- Supports the production of collagen.
- Reduction in tissue tension.
- Analgesic effect.

## Advantage

- 1.By the targeted application of the shockwaves, stress to the surrounding tissues is quite insignificant.
- 2.The body is not burdened by pharmaceuticals, except the short-term effect of local anaesthesia, if used.
- 3.The possibility of preventing the necessity of surgical intervention and its relevant hazards.
- 4.For some indications, such as Tennis Elbow, there is really no other effective treatment.

## Basal Operation

- 1.Put accessories well and connect them to the host.
  - (1)Insert the plug of shockwave work handle into [2] output jack.
  - (2)How to replace adapter please refer to <replace adapter> .
- 2.Insert the plug of power supply line into [8] socket, turn on general power switch [6], put into the system default password “000000”, the system enter interface as (Fig 1) shows.

3.In interface as (Fig 1):

- (1)Click on “Basic setting” to select language, set time and date.

**NOTICE: “Advanced setting” is only for engineering debugging, not for user.**

- (2)Click on the treatment parts icon on the screen which you want to operated on, the system will enter the operation interface automatically.

4.This system include nine operation parts. Elbow, knee, shoulder, hip, pubic symphysis, Hand/wrist, Lumbar Region, foot/ankel, and fat accumulate respectively. The use’s manual use Elbow treatment for example. In interface as (Fig 1), click on “Elbow” to enter interface as (Fig 2) shows.

5.In the interface as (Fig 2):

- (1) “Preselection 2500 Times” stands for when the system works to 2500 times each time, it will pause and promote automatically. Please click on any place of the screen according to the hint.
- (2)“Current” stands for the working times of the current treatment course . The times will be accumulated when the current operation finished each 2500 times. Click on “RESET” to clear the number of current treatment.
- (3) “Frequency 1Hz” stands for per second finished times. The system default frequency is 1 Hz, click on “<” and “>” to regulate, the range is 1 to 21Hz.



(Fig 1)

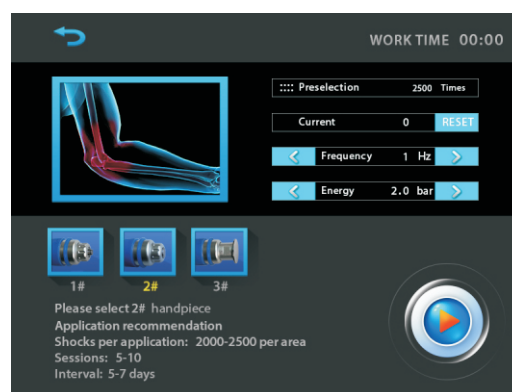

(Fig 2)

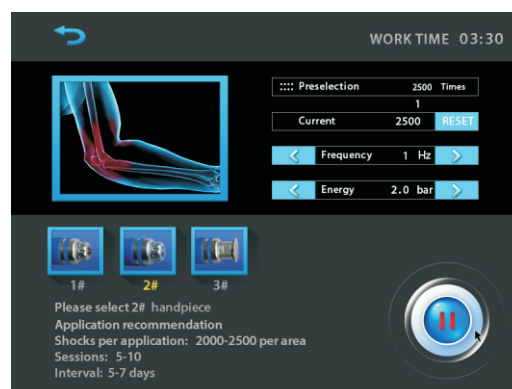

(Fig 3)

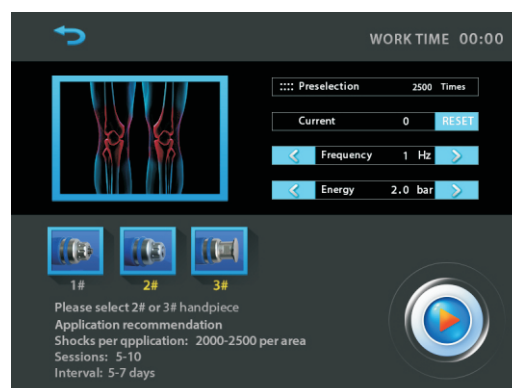

(Fig 4)

(4) "Energy 2.0bar" stands for hit strength, the system default energy is 2.0bar, click on "<" and ">" to regulate. The range is 1.0bar to 4.0bar.

(5) Click on "▶" key, the system is in standby state shooting, as (Fig 3) shows. Beautician press control button on handle once, the handle begin to work. Press on control button again or Click on "||", the system pause.

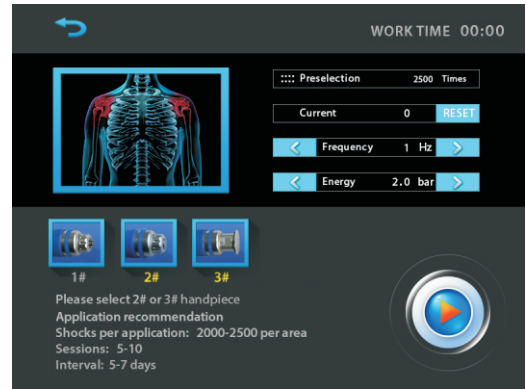

(Fig 5)

6. This machine can click keys on the touchscreen to set the



(Fig 6)

working parameters, it also can use [ 3 ] Function selecting knob & Confirming button to set.

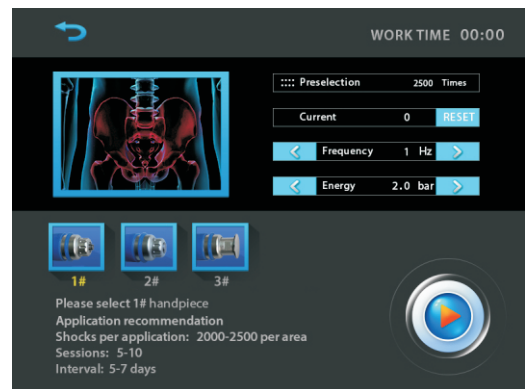

(Fig 7)

Turn the knob when you choose the

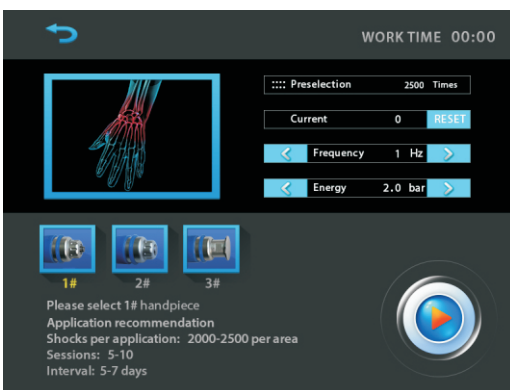

(Fig 8)

function, the icon "👉" move to right place, then press knob [ 3 ] to confirm.



(Fig 9)

7. This use's manual use

touchscreen for example.

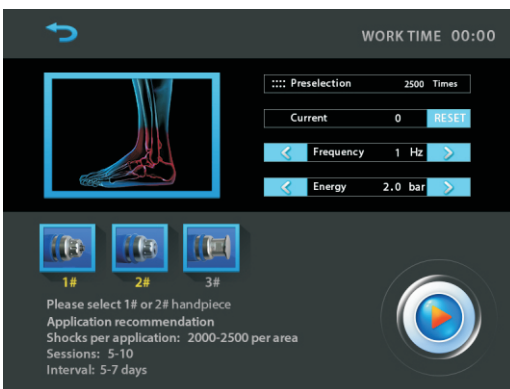

(Fig 10)

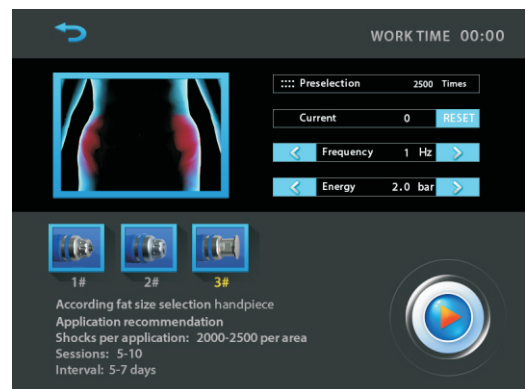

(Fig 11)

---

---

## Operation

1. Clean the treatment part.
2. According to the treatment part to select appropriate adapter.
3. Set suitable frequency (the max range is 1Hz~21Hz) and energy (the max range is 1.0bar~4.0bar).
4. Operating on. Beautician hold the work handle in one hand and place the adapter on area/point of treatment just ok. Click on “▶”, Beautician press control button on handle once, the handle begin to work.
5. Clean the leftovers with hot towel, use warm towel to clean the work head after treatment.

### **Cautions:**

1. You can use a little gel or other lubricants on the treatment parts, but do not use too more, preventing the lubricants get into the work head.
2. Despite high internal damping as a result of the weight and design of the work head, continuous vibrations may cause strain to the user's hand.
3. The adapter is easy wear, please replace after use a period time.
4. The bullet iron pillar inside shockwave handle must replace when the service life is above two million times.
5. Check the filter cup [5] everyday, if it is full above warning line, please clean it immediately.

### **Cleaning Methods:**

**Put some paper at the bottom of the filter cup, rise the valve with your fingers, let the liquid leak. or remove it to pour out, turn to left to unscrew, turn to right to tightening.**

## Contraindications

1. Application to certain tissues: The eyes and the surrounding area, the myocardium, the spinal cord, the gonads, the kidneys and the liver.
2. Blood disorders, coagulation problems or the use of anticoagulants.
3. Blood thinning medications (Warfarinization).
4. Polypus in the area of treatment.
5. Pregnancy; Growing cartilage in children.
6. Tumor diseases; Thrombosis.
7. Polyneuropathy; Acute inflammation.
8. Therapy using corticoids
9. Inapplicable on areas of the body and organs with possible gas content
10. Inapplicable on areas in proximity to large nerve bundles, blood vessels, the spinal cord and the head

---

---

## Possible Side Effects

1. Erythema or swelling can temporarily occur in the treated area.
2. Loss of bodily sensation or itching can temporarily occur in the treated area.
3. Skin damage after previous corticoid therapy.
4. Shockwave application can cause undesirable heart activity.

## Touch Screen Calibration

1. Before turn on the system, please click on the screen, don't move the finger, then turn on the Power Switch.
2. The prompts "Err0" is on the screen, "After releasing the key, we enter into the calibration procedure, Operating under the prompts of the screen". Then release your finger now.
3. Operating under the prompts:
  - (1) Press the cross dot in left-top "+".
  - (2) Press the cross dot in right-top "+".
  - (3) Press the cross dot in right-bottom "+".
  - (4) Click on the point (left top).
  - (5) Click on the point (right bottom).
4. Calibration screen is finished, the system enter "input password" interface.
5. Don't input the password, turn off the Power switch, reboot the system.

## Forbidden Group

1. People with heart disease or high blood pressure, or configured cardiac pacemaker.
2. Patients with acute inflammation, asthma, deep vein thrombosis, thyroncus, cancer.
3. People with hemorrhagic disease, trauma or who is bleeding.
4. Pregnant women.
5. Medical Plastic parts, or parts with artificial in filling inside.
6. People with metal inside the body(include metallic tooth).
7. Patient with skin inflammation or with edema.
8. People with an abnormal immune system.
9. Numb or insensitive to heat.

---

---

## Replace Fuse

- 1.Fuse position 1: Use “-” shape screw wrench to open the fuse seat which under the power supply socket. You can see there are two fuse, inside is spare fuse.
- 2.Fuse position 2: In the back frame of machine. Use “+” shape screw wrench to open. Turn it to left to unscrew fuse seat. Turn it to right to tightening it.
- 3.Fuse model: FL5X20/3.15A with buffer.

## Technical Parameters

Input Voltage: AC 220V□/50Hz □    AC 110V□/60Hz□



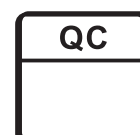

Output Power: 282VA

## Packing List

1.Host	1SET	<input type="checkbox"/>
2.Shockwave work handle	1PC	<input type="checkbox"/>
3.1# Adapter	5PCS	<input type="checkbox"/>
4.2# Adapter	5PCS	<input type="checkbox"/>
5.3# Adapter	5PCS	<input type="checkbox"/>
6.Accessories frame	1PC	<input type="checkbox"/>
7.Power supply line	1PC	<input type="checkbox"/>
8.User manual	1COPY	<input type="checkbox"/>
9.Bullet iron pillar	4PCS	<input type="checkbox"/>
10.Hexagonal wrench(M5)	1PC	<input type="checkbox"/>
11.Hexagonal screw(M6X16mm)	1PC	<input type="checkbox"/>
12.Trolley	1PCS	<input type="checkbox"/>



## Symbols and Meanings

Warning Symbol	Meaning
 Danger	If used incorrectly will bring the risk of death or serious injury!
 Warning	If used incorrectly will cause possibility ill of death or serious injury!
 Attention	If used incorrectly will cause personnel injury or damage to the goods!
 Danger	Device exists high pressure risk of high voltage output terminals!
 Warning	If used incorrectly will cause personnel injury!

\*Things damage refers to housing, property, livestock and pet damage.

## Contraindications

1. The following symptoms were forbidden to use

- (1) Patients who used by Heart rate regulator, cardiac pacemaker, ECS;
- (2) The use of artificial bone; Patients with silicosis;
- (3) Drunk or high fever patients;
- (4) Patients with higher sensitivity mental disease and epilepsy patients
- (5) Patients with no independent expression consciousness and can not take care of themselves.
- (6) Patients with metal materials in body (including metal teeth), pregnant women, cachexia, malignant tumor.
- (7) Severe hypertension and severe patients with cardiovascular and cerebrovascular disease.
- (8) Patients with renal failure.
- (9) Patients with severe infection



**Danger**

2. The following please use under the guidance of professionals

- (1) Women during menstruation;
- (2) Children;
- (3) Hemorrhagic disease or trauma, inflammation, skin disease, skin infection;
- (4) Patients with feeling numb, no response to cold and heat;
- (5) The immune system has defects, scar formation history, physical disease;
- (6) The people who has taken face-lifting or her body has artificial thing.



**Warning**



---

---

## Attention

1. First check the host, accessories, power supply line is broken or not before use.
2. Start system, in addition to television, refrigerator, Do not turn on electrical power device at same time.
3. Before use, please take the hearing aid, electronic wristwatch, magnetic card, mobile phone and other things off first. Pay attention to the child's care to avoid touching.
4. During the using process, drink more water based on your physical.
5. In case of happen special circumstances or accident, please immediately stop using and consult professionals.
6. Patients with following medical electrical device cannot use this system at the same time.
  - Patients who implantable cardiac pacemaker, heart rate regulator, other electronic devices.
  - Artificial heart lung device and other device to sustain life.
  - Patients with ECG scanner device .
  - Patients with metal materials in body (including metal teeth), using artificial bone.
7. The following user should be agreed by the professionals before using this device.
  - Patients with acute disease.
  - Patients with malignant tumor.
  - Patients with Infectious disease.
  - Pregnancy women.
  - Cardiac disease.
  - Patients with high fever.
  - Being treated or physical abnormalities.
8. Please immediately turn off power supply, stop using if following abnormal situation happened.
  - (1) Water and other matter into the host.
  - (2) Host, power supply line, accessories line and plug etc. occur the abnormal heating, leakage.
  - (3) The sound to be unusual.
  - (4) Abnormal smell, smoke.
  - (5) Any accessories damaged.
  - (6) Natural disasters and earthquake, the sudden thunder
9. When the treatment is finished, please cut off the power supply, be sure to unplug the power plug from the power socket.
10. Please check the power supply line, accessories line carefully every time before use, if found damaged, you should stop using and replacing it.
11. Transportation and storage conditions: Transport according to the requirements of the order contract, the transport process should be to prevent sun and rain; packaged equipment should be stored in relative humidity of not more than 80%, no corrosive gas and ventilated room.
12. The warning mark produce in the specification, its purpose is to enable you to safely and correctly using this device, and to prevent you and others to injury.



## Maintenance

1. Appliances and medical equipment close to the machine may be resulting in operational failure due to interference.
2. Prohibit use of the equipment in the following environment
  - Hot and humid environment
  - Dusty environment
  - Environmental with much smoke or steam
3. If there comes a failure, please shut down the power immediately, and send it to the distributor or manufacturer for maintenance. Do not repair by yourself.

### 4. Exclusion of liability.

**The Company is not responsible for the following circumstances:**

- (1) If fire, earthquake, war occurred;
  - (2) The fault of the user, operator error;
  - (3) Damage caused by using other method (not included in the use manual).
  - (4) Operate without the manual's guide.
5. Do not make the machine close to the wall, keeping a 30CM space around for cooling.

## Safety and Environmental Considerations

### Hazardous Substances or Elements Contained in the Product

Part Name	Toxic and Hazardous Substance or Element						Remark
	Lead (Pb)	Mercury (Hg)	Cadmium (Cd)	Hexavalent chromium (Cr(VI))	Polybrominated biphenyls (PBB)	Polybrominated diphenyl ethers (PBDE)	
Plastic parts	○	○	○	○	×	×	
Metal structures /decorations	×	○	○	○	○	○	
Printed Circuit Assembly	×	○	○	○	○	○	
Power Line	×	○	○	○	○	○	
Plug of Power supply line	×	○	○	○	○	○	
Relay	○	○	×	○	○	○	
Buzzer	×	○	○	○	○	○	

- × Toxic and hazardous substance in at least one homogeneous materials of the part exceeds the concentration limit requirement described in SJ/T11363-2006.
- Toxic and hazardous substance in all the homogeneous materials of the part is either below the concentration limit requirement described in SJ/T11363-2006 or is not applicable because the part is not used.
- Products to be discarded after use, Please treat in accordance with electronic and information products recovery, re-use legal regulations.

#### Technical note:

Hardware structure of the machine parts, injection molded parts, and the majority of electronic components, connectors meet the requirements of the EU and China RoHS directives. Only a few parts as the global technology limitations that may affect product reliability, and not find a substitute for the toxic and hazardous substances, please be assured to use, use under normal conditions will not cause health effects on users.