

1.6

6	7	8
EC No.	EC Description	DR.
△	/	/

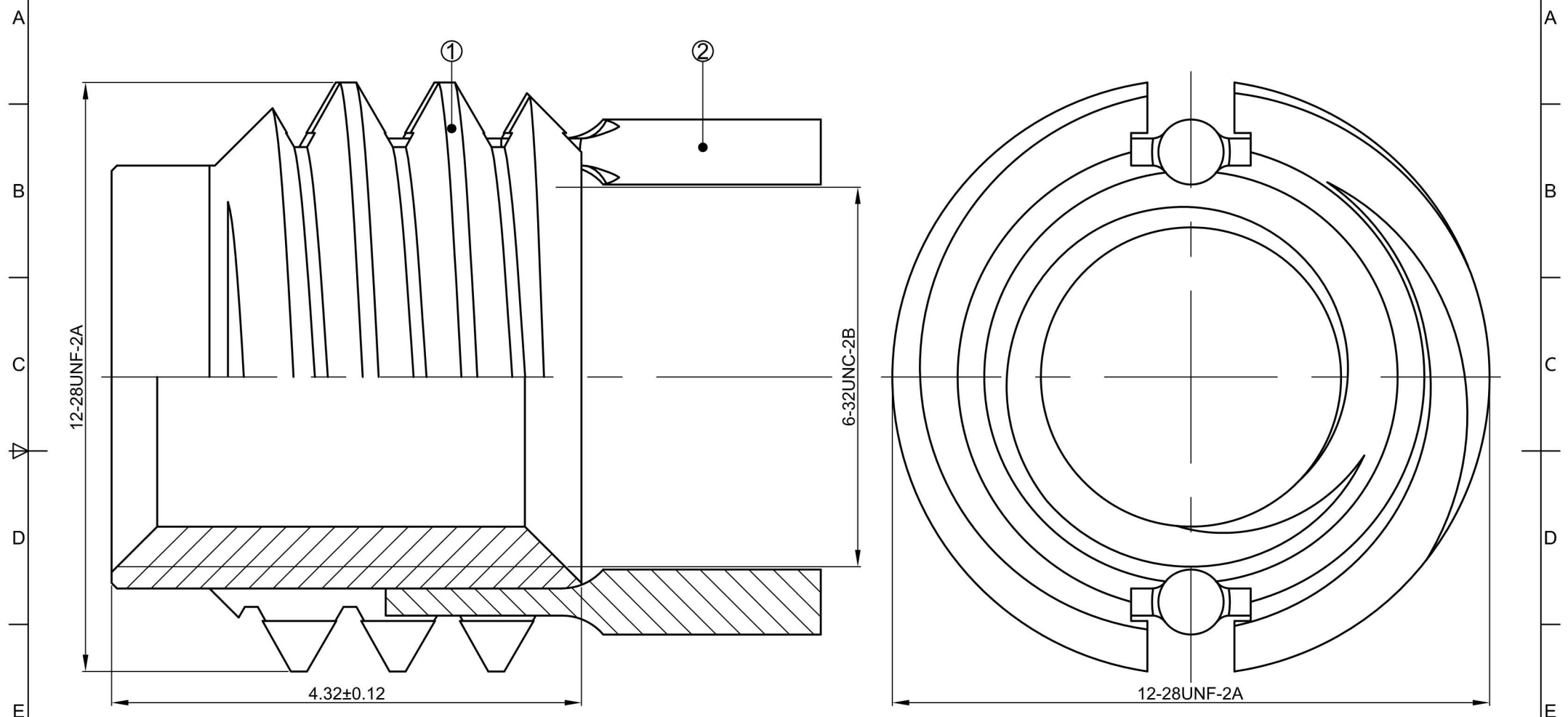

- NOTES:
- Material: ①Inserts: SUS303; ②Keys: SUS302;
 - Heat Treatment: None;
 - Surface Treatment: Passivated;
 - Packaging: PE bag and Carton;
 - Free of burrs and sharp edges;
 - Thread must be checked with Go/No Go Gauge;
 - Unless otherwise specified: ±0.1mm and angle ±2°.

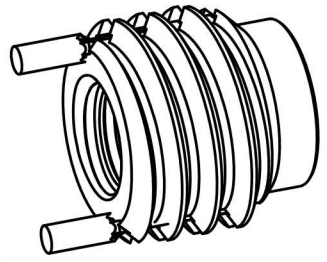

In-sail®
力帆精密&力本五金

UNIT: mm

DIM Tol.:	Angle Tol.:
X ±	X° ±
.X ±	.X° ±
.XX ±	.XX° ±
.XXX ±	.XXX° ±

①	1	/	/	See Note 1	See Note 3	/
Part Item	QTY.	Name	Description	Material	Surface Treatment	Remark
DR.	JRL 2019.11.16	CHKD.	APPD.	Unit net weight ≈ / g		Rough weight ≈ / g
Shenzhen In-sail Precision Parts Co., Ltd				TITLE: L5010-632x4.32-1228SS		
The Drawing and Specification are the Property of Shenzhen In-sail Precision Parts Co., Ltd. Without the Prior Written Permission of Top Management, any person or party except the intended ones is prohibited to Copy, Reproduce, Duplicate this document, Please send email to sales@in-sail.com if you have any request.				Drawing#: L501003A	P/N: /	REV. A Sheet 1 of 1