

# GRENTSUN Laser User's Guide

Feb. 1, 2025

## List

|  |    |
|--|----|
| 1. Home .....                            | 4  |
| 1.1. Login .....                         | 4  |
| 1.2. System status bar .....             | 4  |
| 1.3. Edit bar .....                      | 7  |
| 1.3.1. Add text .....                    | 8  |
| 1.3.2. Draw .....                        | 20 |
| 1.3.3. Add Line .....                    | 22 |
| 1.3.4. Add graph .....                   | 26 |
| 1.3.5. Add barcode .....                 | 26 |
| 1.3.6. Add QR code .....                 | 32 |
| 1.3.7. Add delayer .....                 | 40 |
| 1.3.8. New .....                         | 41 |
| 1.3.9. Open .....                        | 41 |
| 1.3.10. Save .....                       | 43 |
| 1.3.11. Save as .....                    | 43 |
| 1.3.12. Undo .....                       | 43 |
| 1.3.13. Redo .....                       | 43 |
| 1.3.14. Copy .....                       | 43 |
| 1.3.15. Delete .....                     | 43 |
| 1.3.16. Tool .....                       | 43 |
| 1.3.17. Object .....                     | 44 |
| 1.3.18. Arc text .....                   | 47 |
| 1.3.19. Fill .....                       | 48 |
| 1.3.20. Array .....                      | 50 |
| 1.3.21. Marking parameters .....         | 51 |
| 1.3.22. Dimensions and coordinates ..... | 52 |
| 1.3.23. Document management .....        | 52 |
| 1.4. System toolbar .....                | 54 |
| 2. Keyboard introduction .....           | 54 |
| 3. Production line settings .....        | 55 |
| 3.1.1. Static coding settings .....      | 55 |
| 3.1.2. Flight marking settings .....     | 58 |
| 4. Setting .....                         | 67 |
| 4.1. Marking parameters .....            | 67 |
| 4.2. Area .....                          | 73 |
| 4.2.1. Galvanometer calibration .....    | 73 |
| 4.2.2. Red light guide calibration ..... | 76 |
| 4.3. Laser .....                         | 78 |
| 4.4. User rights .....                   | 82 |
| 4.5. System settings .....               | 84 |
| 4.6. IO settings .....                   | 90 |
| 4.7. Communication settings .....        | 94 |

|                            |    |
|----------------------------|----|
| 4.8. System info .....     | 94 |
| 4.8.1. System update ..... | 95 |
| 4.8.2. Registered .....    | 97 |
| 5. Alarm information ..... | 99 |

# 1. Home

The main interface is shown in Figure 1-1:

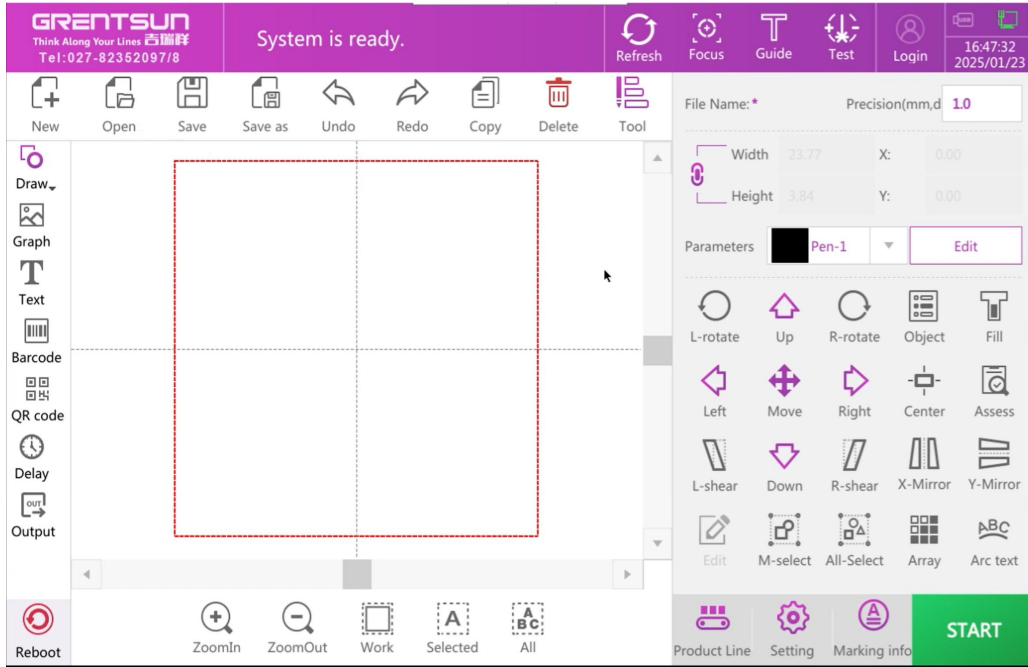



Figure 1-1

## 1.1. Login

Click the  button, a password input interface pops up, login password: 123 (administrator, you can log in to the system with different permissions)

## 1.2. System status bar

As shown in Figure 1-2



Figure 1-2

**System status prompt:** Prompt that the coding system is ready, marking, or some error alarm information, etc.

**Refresh:** During the flight marking process, the information can be updated online. There are two situations for online update. One is to update the marking after performing the system cache twice, that is, after clicking online update, the system will perform another marking and update on the content once. The modified content is marked, a real-time update, that is, after clicking online update, the system's next marking is the modified content (for high-speed production lines, real-time update will cause missed marking)

**Focus light:** This function can be used when a red light focusing red light tube is connected to the system, that is, two red lights are connected.

**Guide light:** The red light guides the light and previews the data marking area.

**Test:** Test the marking time of the currently selected data, the marking time can be seen in the status bar after marking.

**Marking info:** Click the button, the pop-up interface as shown in Figure 1-3.

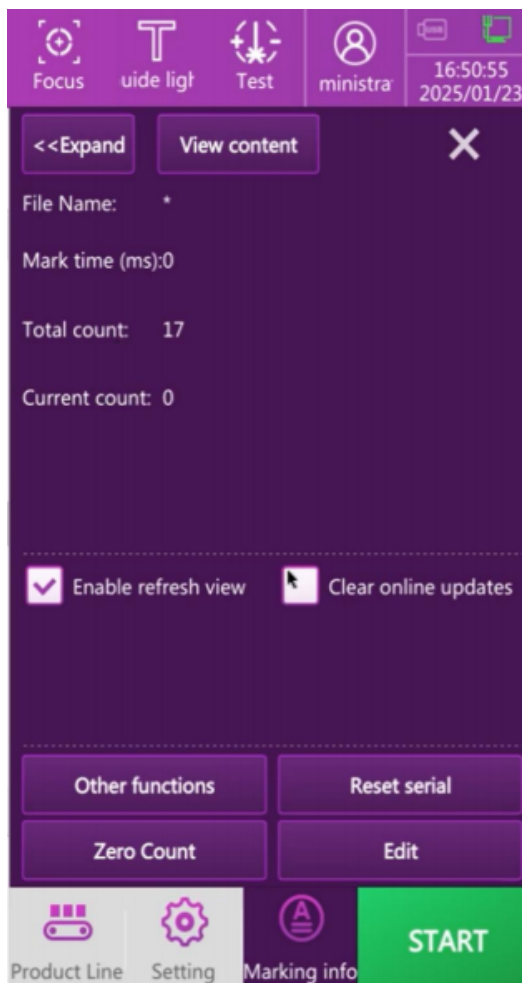


图 1-3

**View content:**View the current marking content.

**File name:**Display the file currently being marked.

**Marking time(S):**Current file marking time.

**Current times:**Count the number of markings after clicking start coding.

**Speed(m/min):**The current encoder obtains the real-time speed of the pipeline or the simulated speed set by the system.

**Refresh view:**During the marking process, the interface content display is refreshed in real time.

**Clear cache:**When using the online update function, whether to clear the

previous state of the marked content in real time. When it is not checked, the system will update the marking after 2 caches. The system will mark the content twice and update the modified content for marking. When checked, it will be updated in real time, that is, after clicking online update, The next marking of the system is the content after modification (for high-speed production lines, real-time update will cause missed printing)

**Clear alarm:**Clear alarm information.

**Reset serial number:** The serial number can be reset without stopping production.

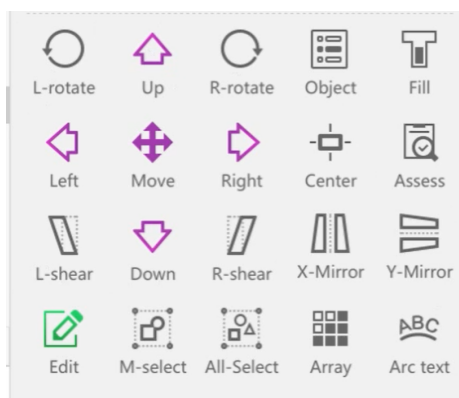
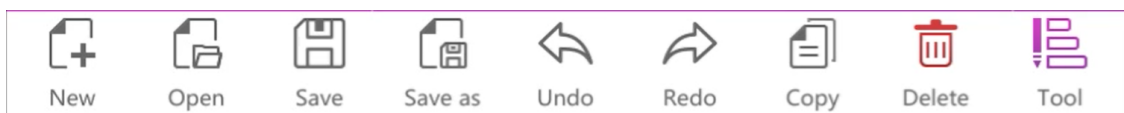
**Clear count:** Clear current or total times.

**Edit:**Online editing function, during the marking process, click to return to editing, after the data is modified, click the online update function.



**Start/pause marking button**

### 1.3. Edit bar




**Precision:**Up, down, left or right, or the distance or angle traveled by each point of the rotary button (unit: mm/deg).

### Add object

Add materials that need to be marked, including text, points, lines, circles, rectangles, barcodes, QR codes, graphics, delayer.

#### 1.3.1. Add text

Click the text button  to enter the content editing interface, as shown in Figure 2-2.

**Up:**Adjust the data order, the data moves forward.

**Down:**Adjust the data order, the data moves backward.

**Edit:**Edit fixed text, serial number, date and time, file reading, shift code, system variable or random code.

**Delete:**Delete added content.

**New line:**Branch add information

**Manage:** Management variables

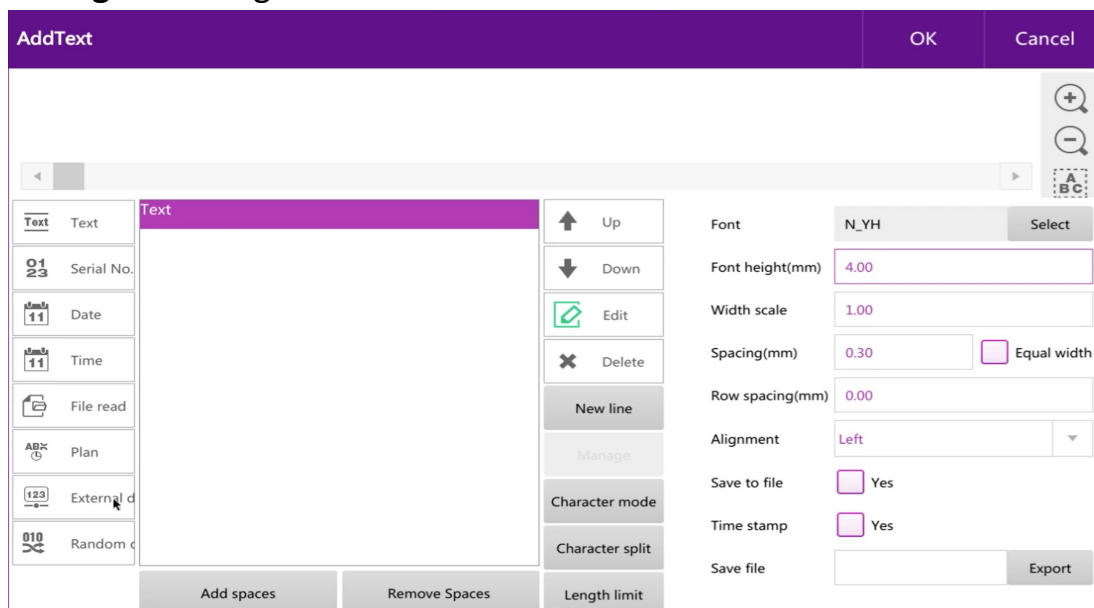


Figure 2-1

### **1.3.1.1. Add text**

After entering the content editing interface, the system will automatically produce a fixed text with empty text. Click Edit to pop up the text box, click the blank area, and pop up the keyboard. To add new fixed text, click the fixed text button to add the default content as TEXT Fixed text.

#### **Edit text**

Select the text TEXT, as shown in Figure 2-2, click the edit button to enter the editing interface, click the content box, and the keyboard pops up, as shown in Figure 2-3.

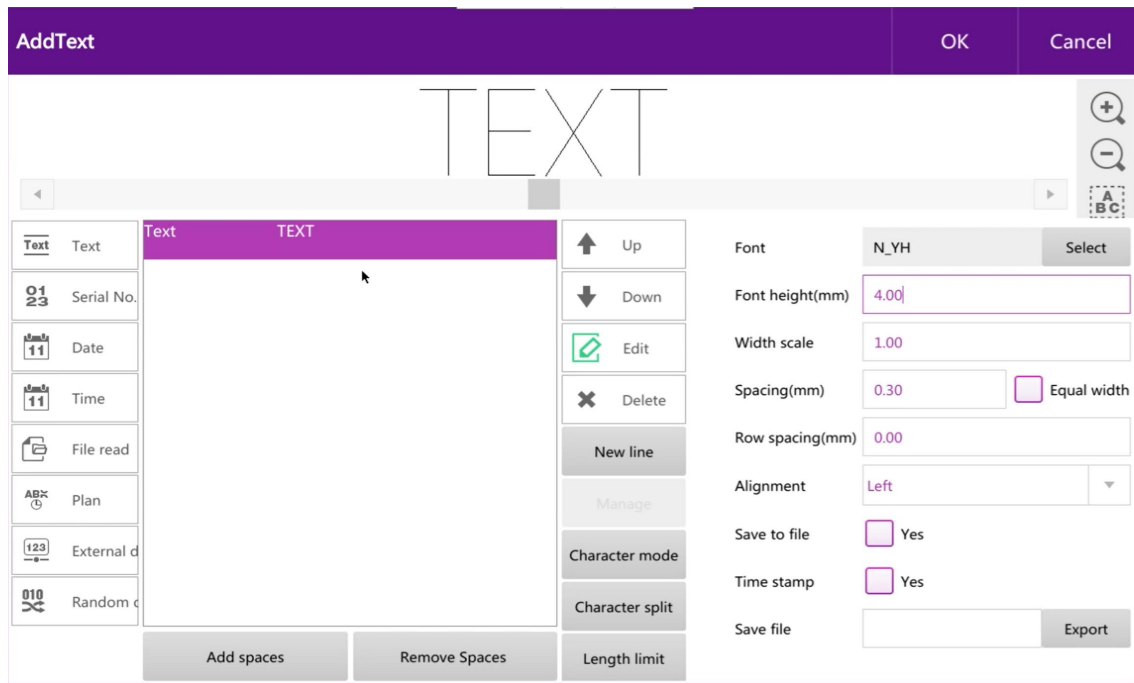


Figure 2- 2

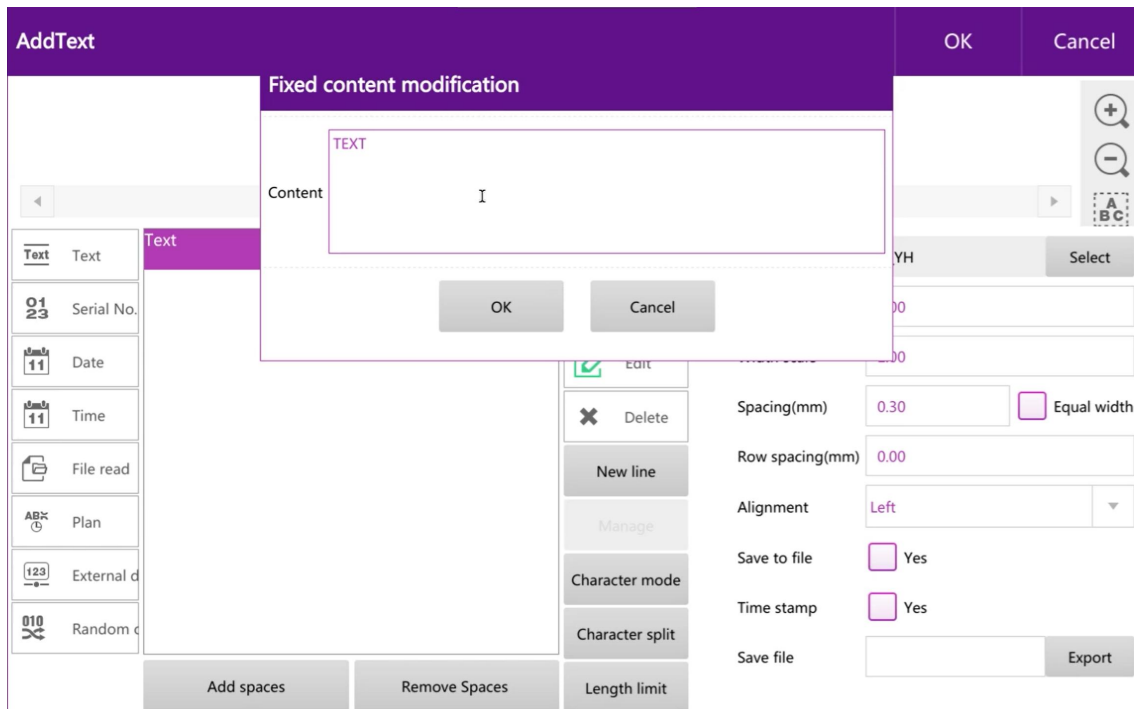


Figure 2-3

**Font:** Select text font, optional dot matrix font, single line font or double line font, as shown in Figure 2-4.



Figure 2-4

**Char height:**Character height.

**Width scale:**The default value is 1, change the font width.

**Spacing:**Distance between characters.

**Monospaced:** Set each character to the same placeholder width

**Line space:**The distance between each line and each line in the same text.

**Alignment:**Alignment between multiple lines in the same book.

**Save to file,Time stamp, Save file:**Record role, record usage.

### 1.3.1.2. Add serial number

Click the serial number button to add a serial number with a default content of 0000, as shown in Figure 2-5.

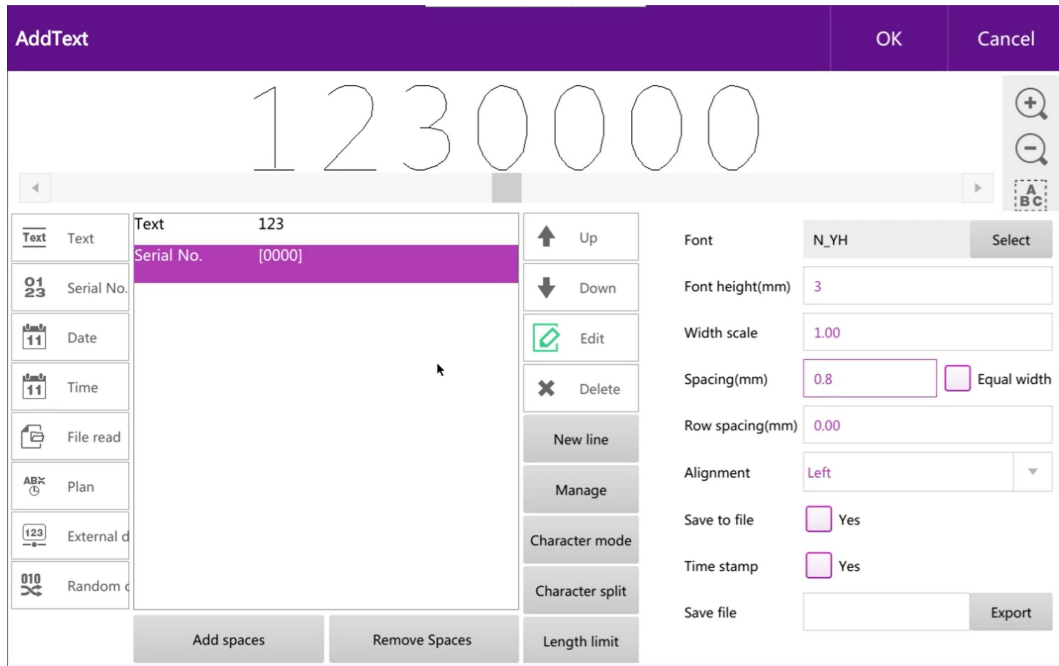


Figure 2-5

### Edit serial number

Select the serial number and click the edit button to pop up the serial number modification interface, as shown in Figure 2-6

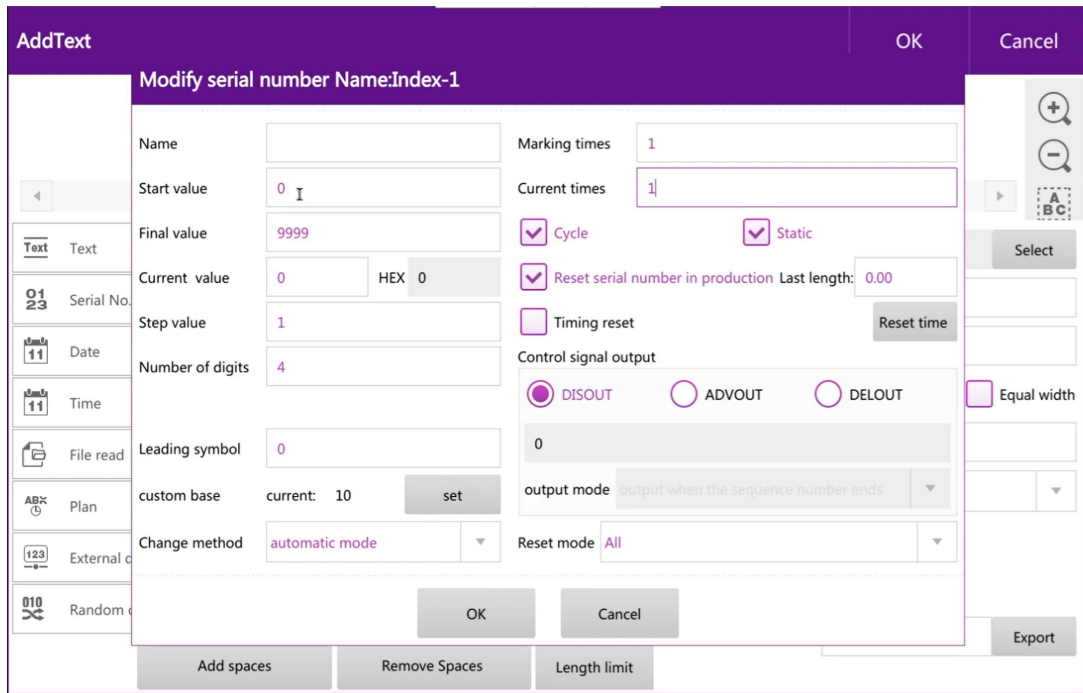


Figure 2-6

| <b>Start value</b>      | Starting value                                  | <b>Final value</b>    | Final value                                  |
|-------------------------|---|-----------------------|--|
| <b>Current value</b>    | Serial number to be marked                      | <b>Step value</b>     | Accumulated value for each marking           |
| <b>Number of digits</b> | Number of characters                            | <b>Leading symbol</b> | Character expression symbol                  |
| <b>Marking times</b>    | Number of repetitions of a single serial number | <b>Current times</b>  | Repeated serial number has been marked times |

|  |  |  |  |
|--|--|--|--|
| <b>Cycle</b>   | Whether the serial number is cyclically marked | <b>Reset serial number in production</b> | After ticking, the reset serial number function will take effect |
| <p><b>Control signal output:</b>Serial number signal output.</p> <p><b>ADVOUT:</b> Output several serial numbers in advance.</p> <p><b>DELOUT:</b> Delay distance output, unit mm, the value can not be set too much, otherwise it will alarm.</p> |  |  |  |

### 1.3.1.3. Add date and time

Click the date /time button, the added date and time is the system date and time, as shown in Figure 2-7.

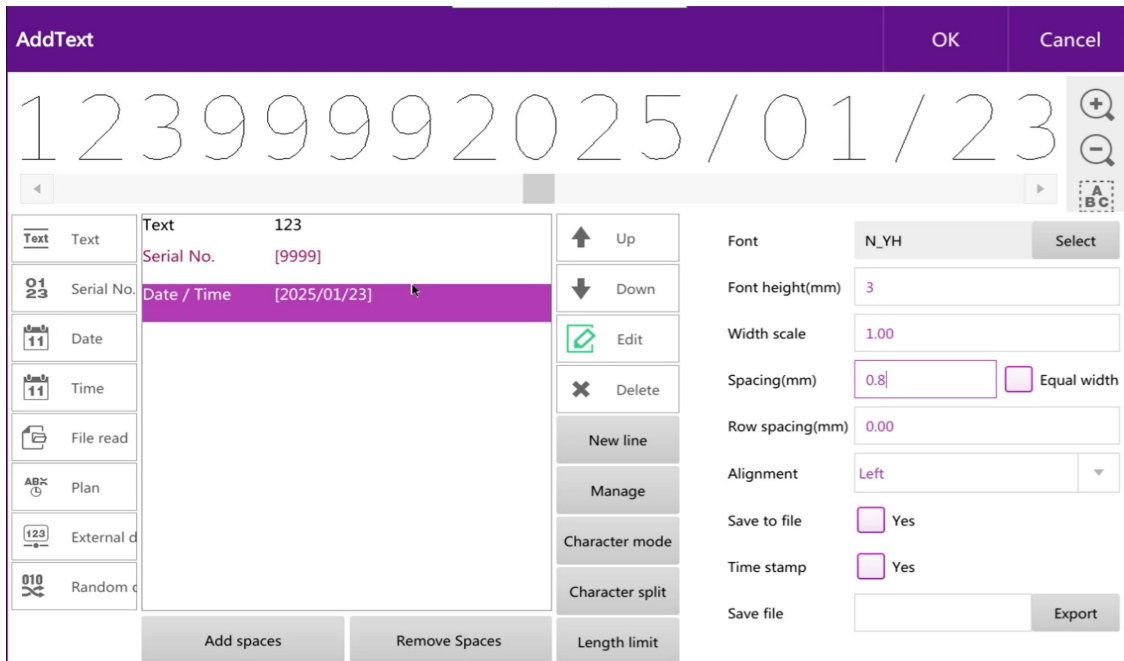


Figure 2-7

## Edit Date/ time

Select the Date/ time and click the edit button to pop up the time/date modification interface, as shown in Figure 2-8.

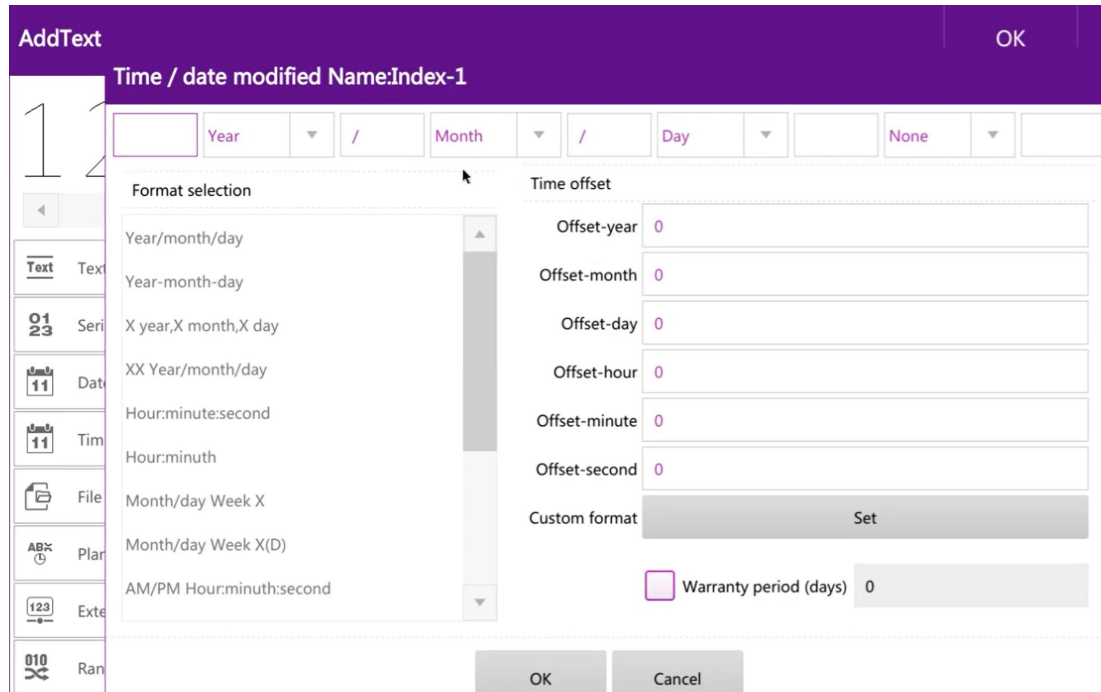
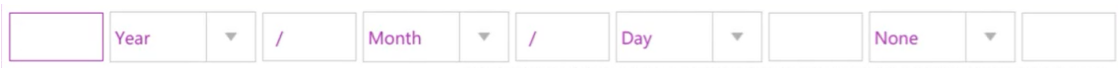


Figure 2-8

**Select format:** The system has its own time and date format, which can be used directly.

**Modify the format:** Modify the time/date format, you can modify the delimiter, and the order of year, month, day, etc.



**Time offset:** You can change days, hours, and minutes, that is, increase or decrease the set value on the basis of the current time, accumulate one day and change the value after the day to 1, and decrease the day and change the value after the day to -1. The same is true for hours and minutes.

Time offset

|               |     |
|---------------|-----|
| Offset-year   | 0   |
| Offset-month  | 0   |
| Offset-day    | 0   |
| Offset-hour   | 0   |
| Offset-minute | 0   |
| Offset-second | 0   |
| Custom format | Set |

Warranty period (days) 0

### 1.3.1.4. File read

Click the file read button to add a blank file, as shown in Figure 2-9.

|            |             |            |
|------------|-------------|------------|
| Text       | Text        | 123        |
| Text       | Text        | [↓]        |
| Serial No. | Serial No.  | [9999]     |
| Date       | Text        | [↓]        |
| Time       | Date / Time | [20250123] |
| File read  | Text        | [↓]        |
| Plan       | Date / Time | [17:21]    |
| External d |             |            |

Figure 2-9

### Edit File read

Select the file to read and click the edit button to pop up the file reading and modification interface, as shown in Figure 2-10.

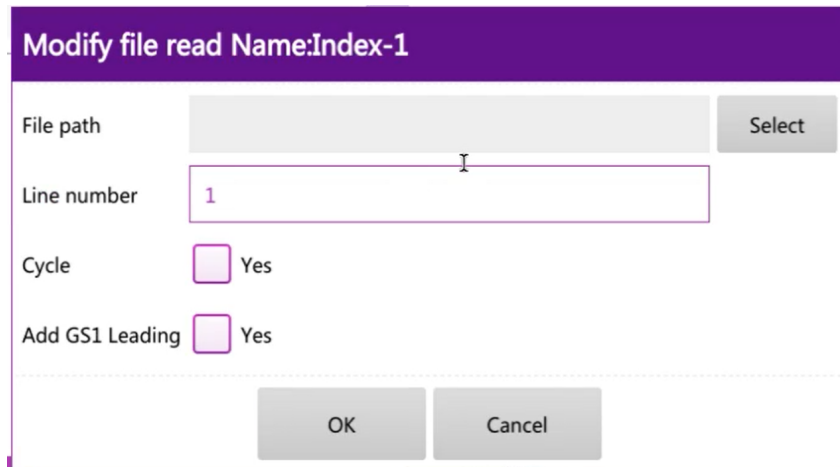


Figure 2-10

### Select a document

Click the selection button behind the file path to pop up the file path (inside the system or USB), select the file to be loaded, as shown in Figure 2-11.

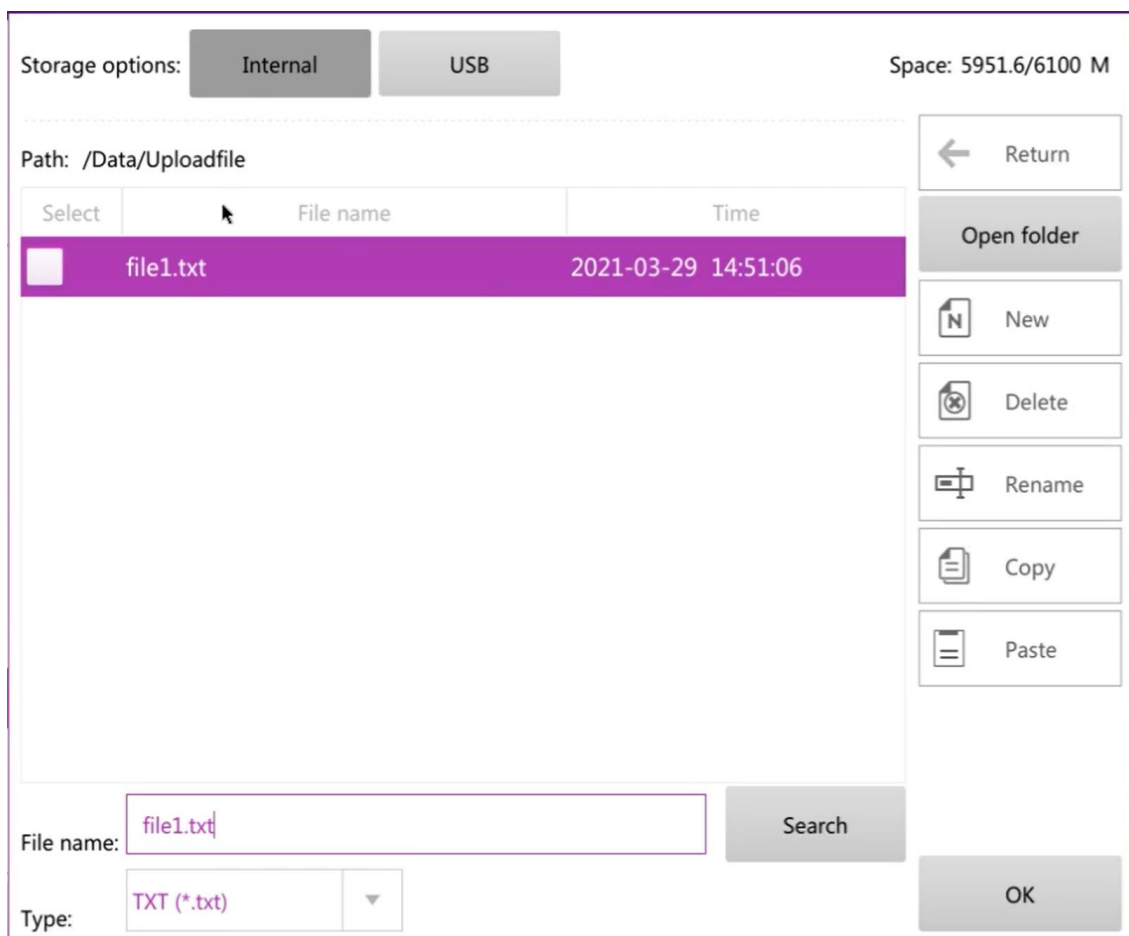


Figure 2-11

**Line number:**The line number of the text to be marked currently.

**Cycle:**Whether to mark the text file cyclically.

### 1.3.1.5. Add Plan

Click the Plan button, as shown in Figure 2-12, click the edit button, you can edit the code skip information, as shown in Figure 2-13.

**Add:**Add the code hopping list, as shown in Figure 2-14.

**Delete:** Delete skip code list.

**Edit:** Edit timing code hopping information, for example:

Click the edit button in Figure 2-12 to enter the code skipping content editing interface, as shown in Figure 2-15, modify the code skipping information and start time. Figure 2-14 represents the meaning of 00:00:00-12:00:00 Code shift information A, code jump code information B from 12:00:00-00:00:00.



Figure 2-12

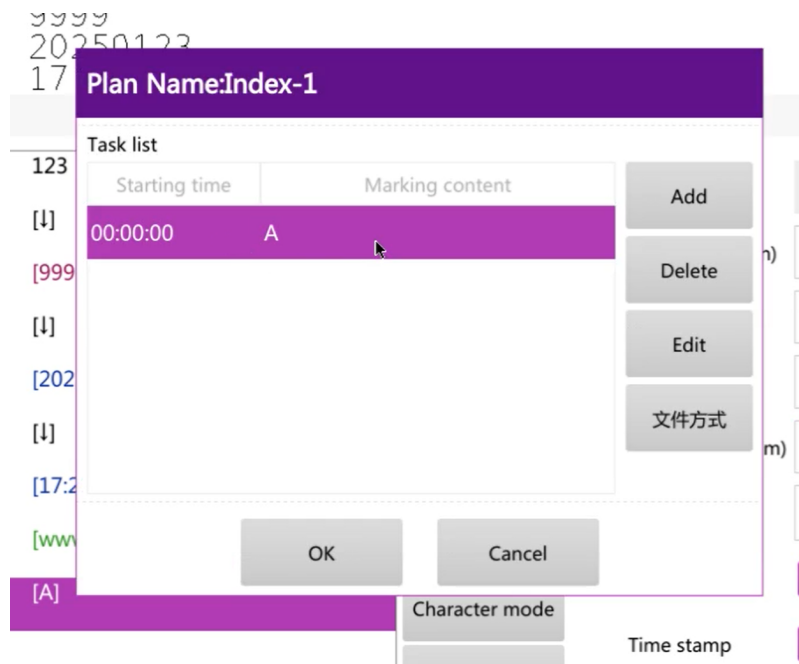


Figure 2-13

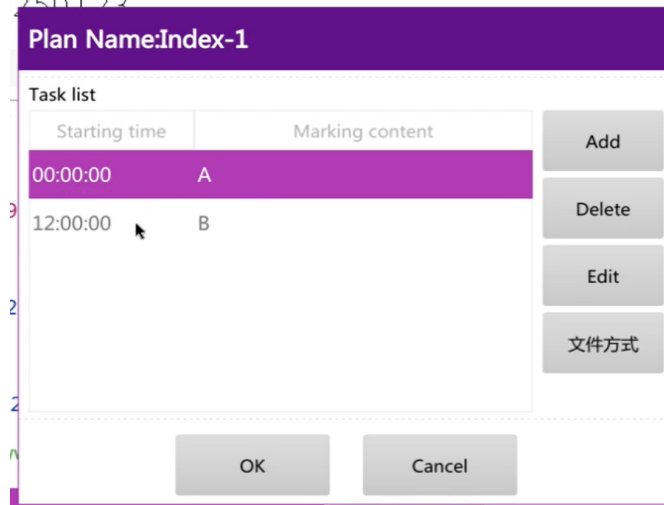


Figure 2-14

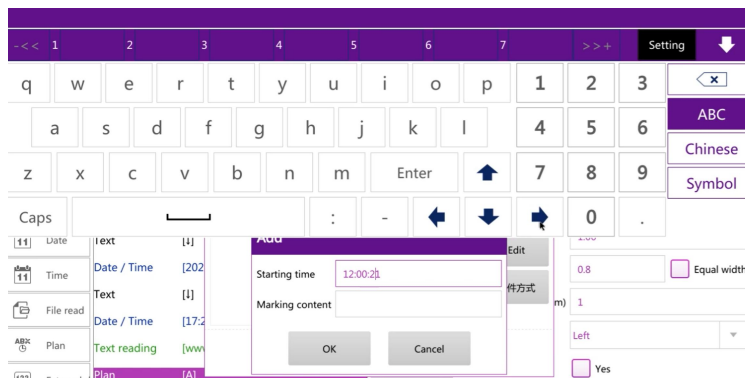


Figure 2-15

### 1.3.1.6. Add variable

Communication function, please contact the engineer when using.

### 1.3.1.7. Add random code

The system randomly generates data for marking.

## 1.3.2. Draw

Drawing functions include straight lines, dashed lines, points, circles, rectangles, etc.

### 1.3.2.1. Add Dot

Click the dot button in the drawing function, as shown in Figure 2-16, you can modify the dot pulse number or dot time in the setting---spraying parameters (when  $\checkmark$  is selected, it is dot time output, when it is not selected, it is dot pulse output).

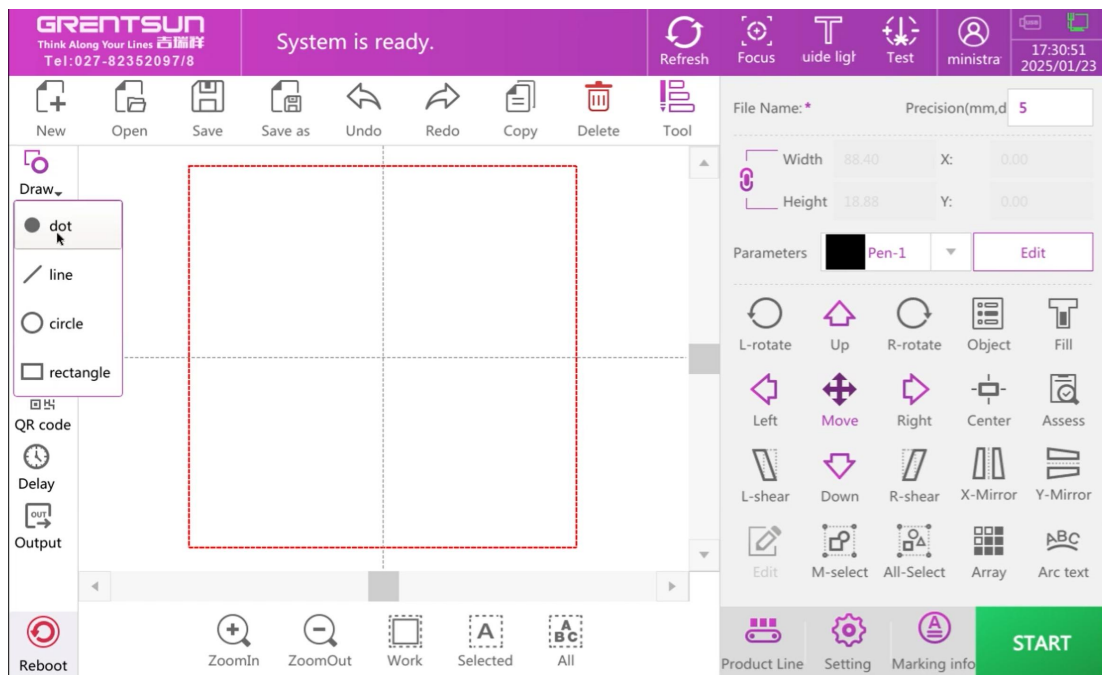


Figure 2- 16

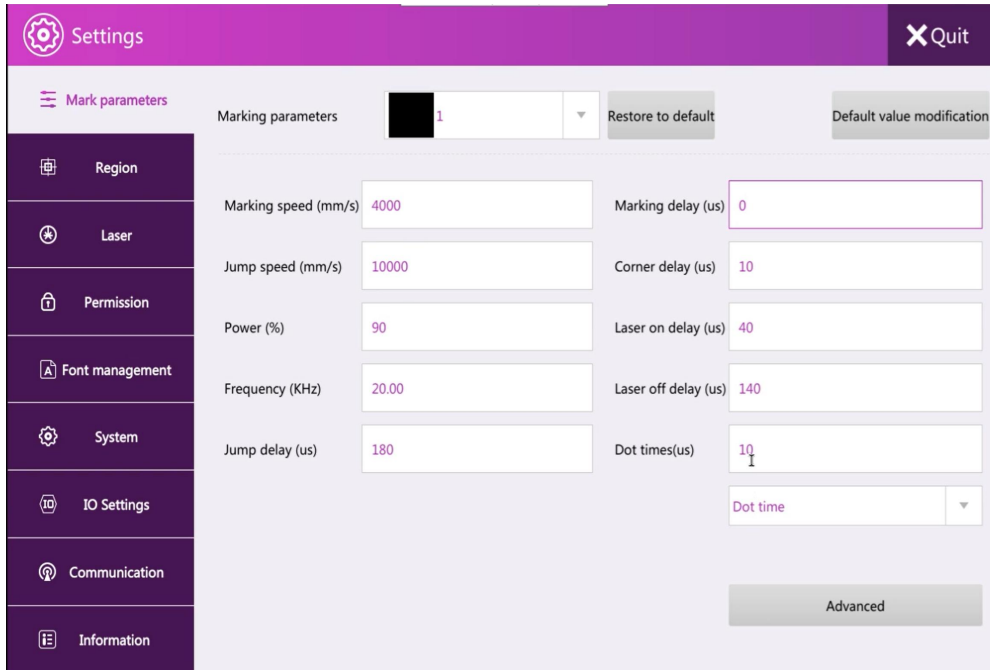


Figure 2-17

### 1.3.3. Add Line

Click the center line button of the drawing function to add ordinary straight line, tear line--dotted line, tear line--circle, tear line--point. As shown in Figure 2-18.

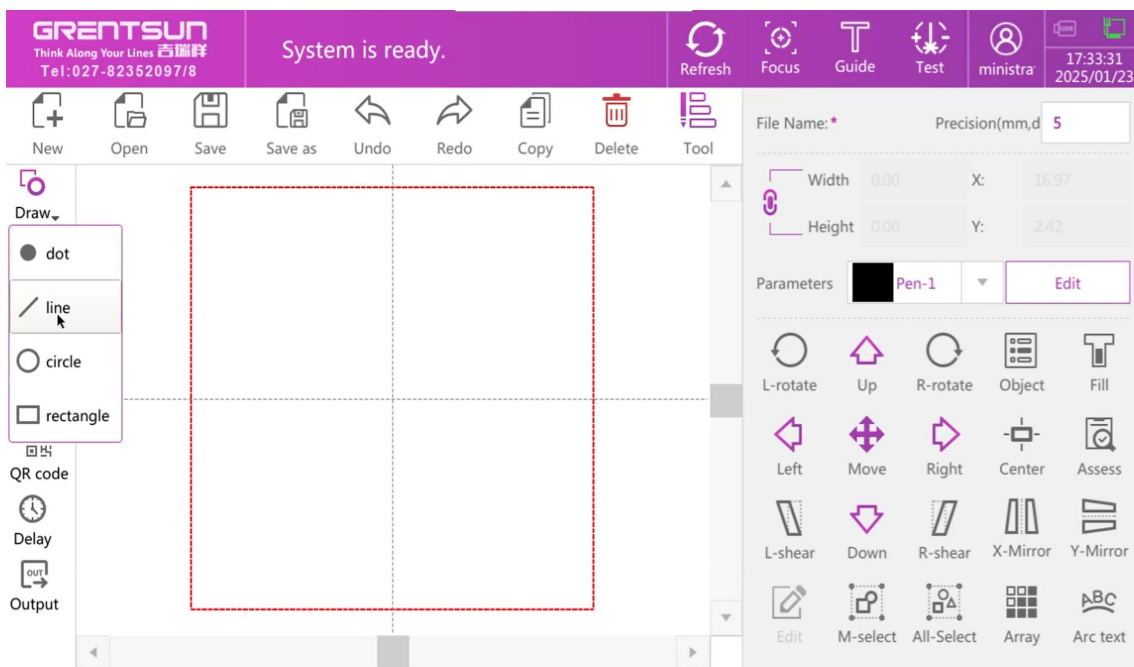


Figure 2- 18

### 1.3.3.1. Add normal straight line

The line type is selected as a straight line, and the line length can be set, as shown in Figure 2-19 and Figure 2-20.

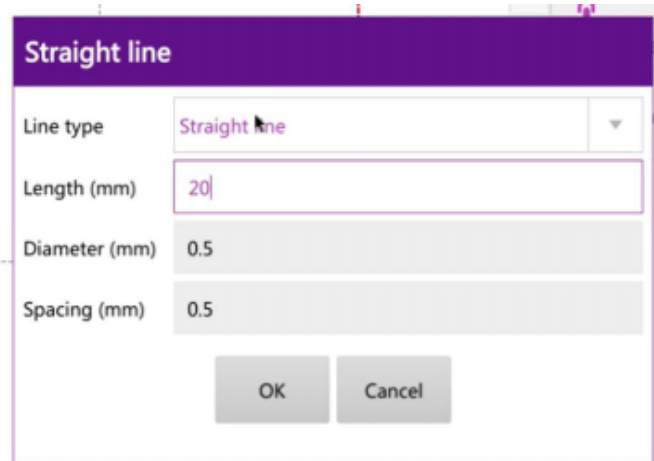


Figure 2-19

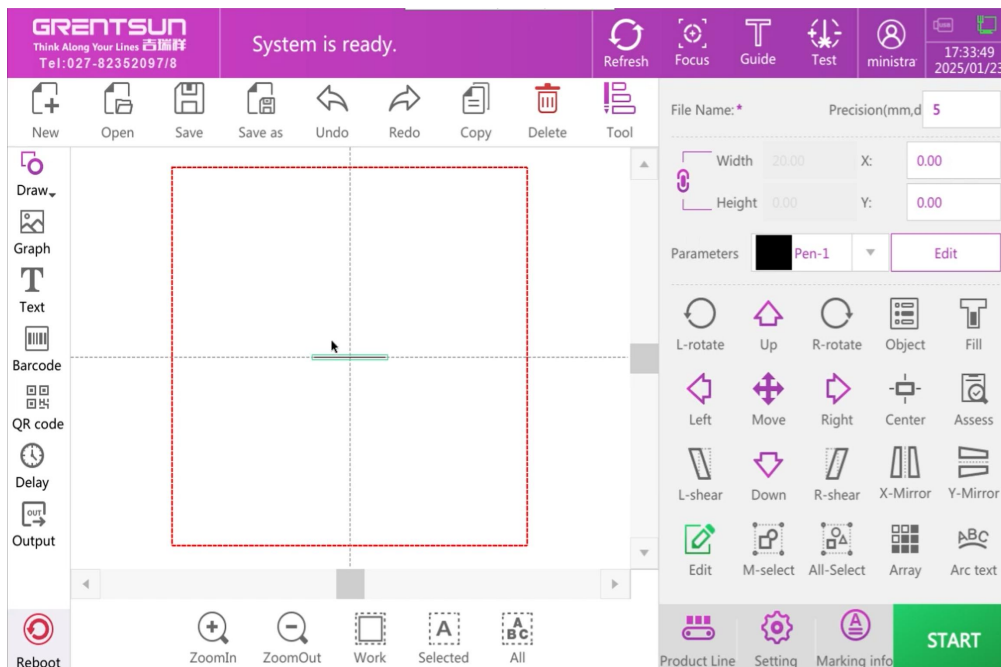


Figure 2- 20

### 1.3.3.2. Add Tear line

The tear line type includes dotted lines, circles, or dots, as shown in Figure 2-21, and the diameter or spacing of each unit can be set.

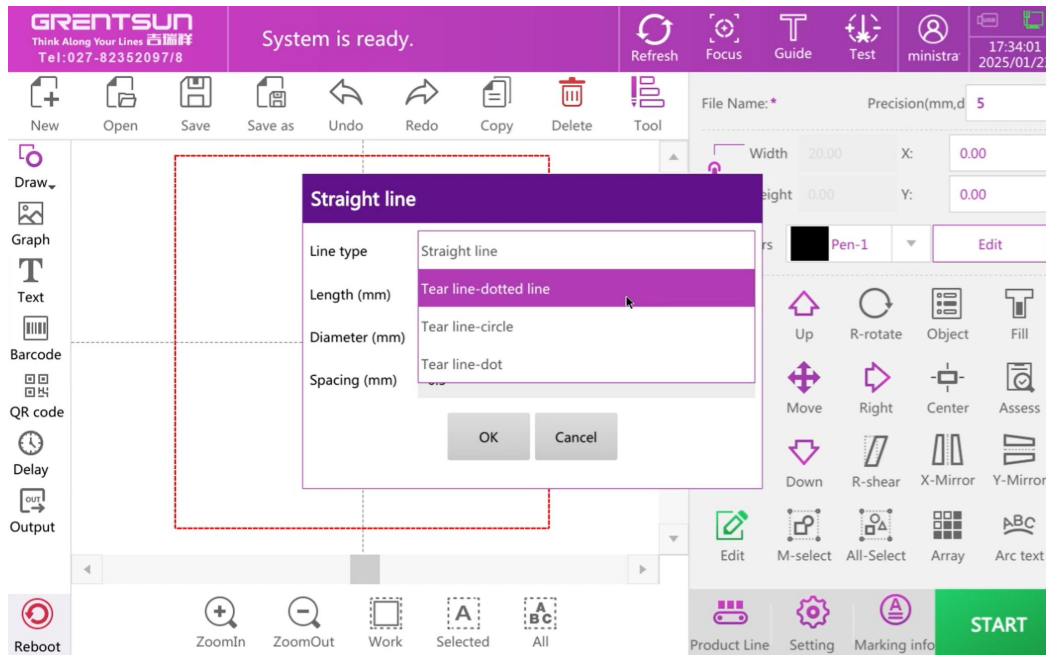


Figure 2- 21

### 1.3.3.3. Add Circle

Click the circle button in the drawing, as shown in Figure 2-22.

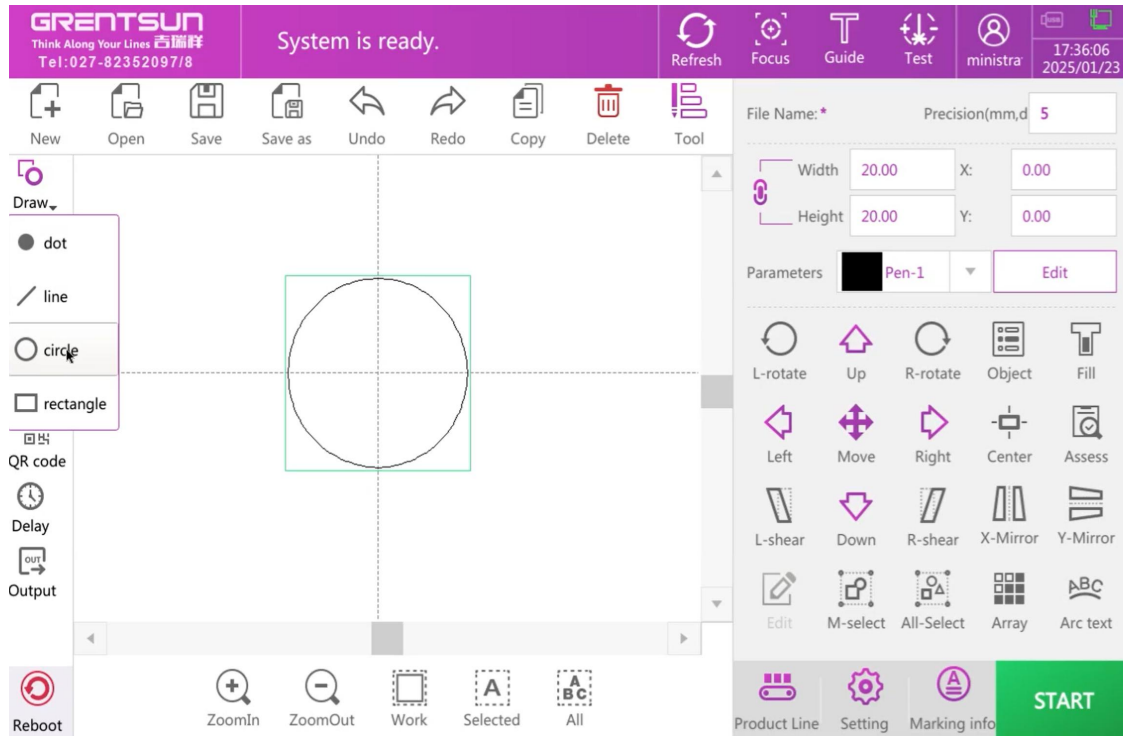


Figure 2- 22

### 1.3.3.4. Add rectangle

Click the rectangular button in the drawing, as shown in Figure 2-23.

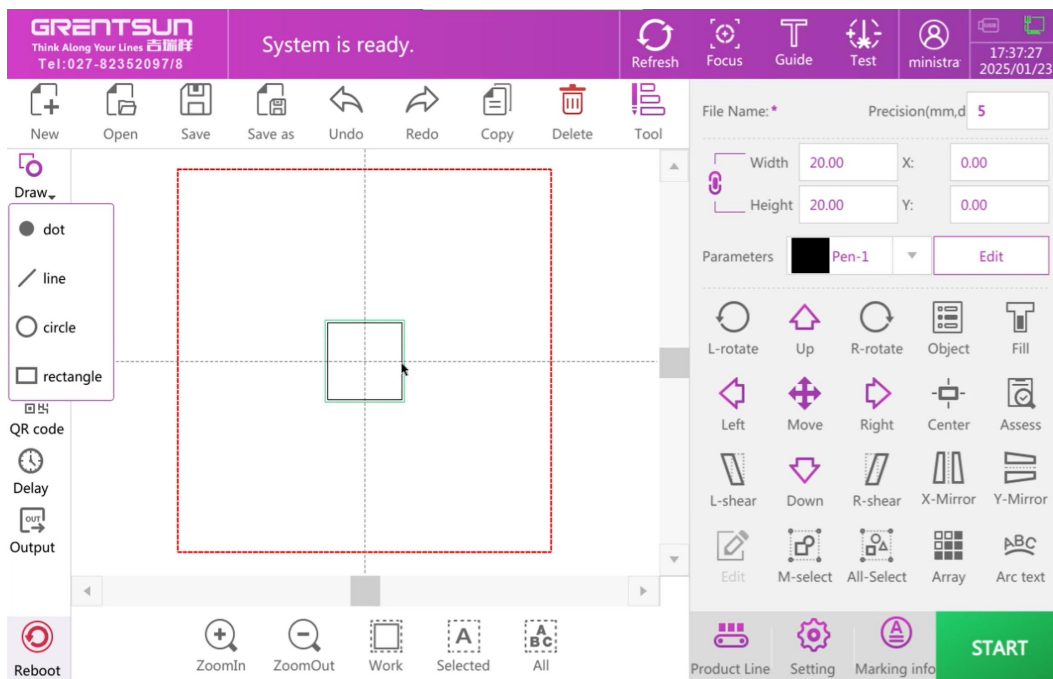


Figure 2- 23

### 1.3.4. Add graph

Click the graph button, and the add interface pops up, as shown in Figure 2-24. Supported formats: dxf, plt, jpg, png, bmp, etc.

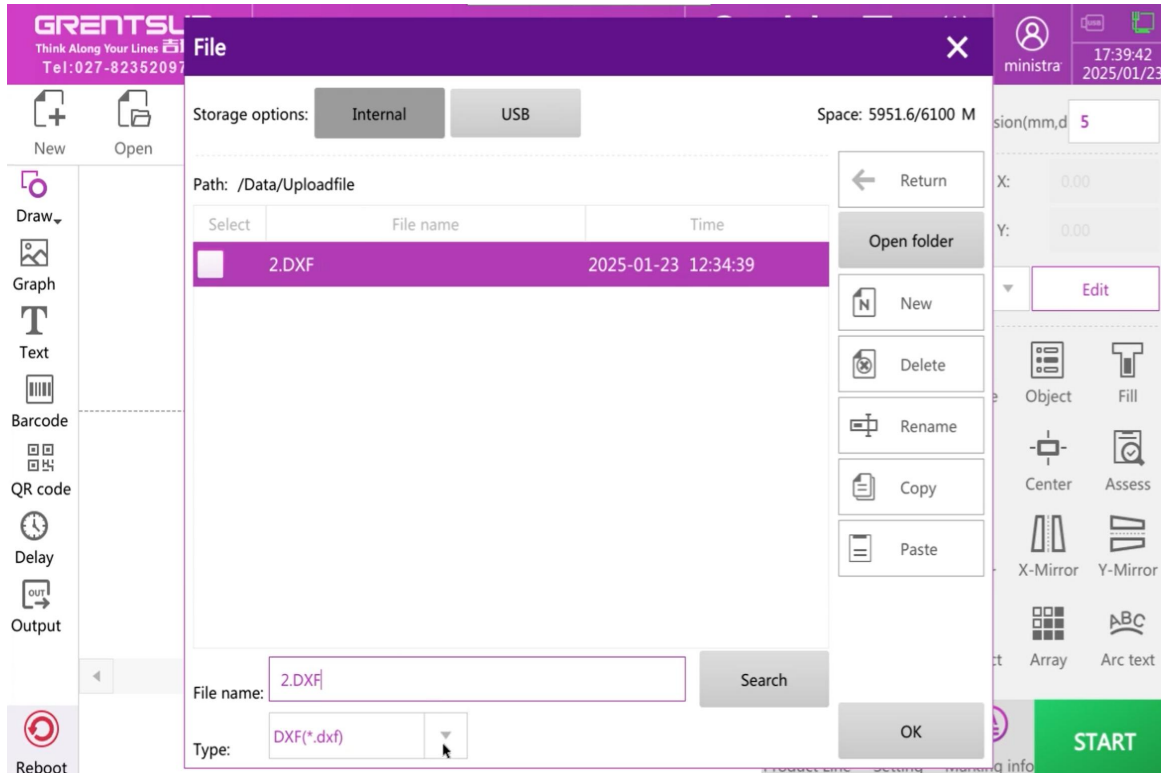


Figure 2- 24

### 1.3.5. Add barcode

Click the barcode button to pop up the content editing interface. The default content is a QR code of 123, as shown in Figure 2-25.

#### Code

**Reverse:**After checking, the bar code becomes reverse code, and the bar code border should be set at this time, as shown in the figure below.



(Forward)



(Reverse border)

**Type:**Select barcode type, Code128, Code39, Code93 are optional

**Height:**Barcode height.

**Blank:**When there is a border, the distance between the barcode and the border.

### **Text**

**Display text:**After checking, the barcode content will be displayed.

**Font:**Text content font

**Char height:**Character height

**Char space:**Character spacing

**Horizontal offset:**The horizontal offset of the text content

**Vertical offset:**The vertical offset of the text content

Save to file, Timestamp, Save the file as a record, usually not used

**Modified content:**Click the content box behind the text to enter the content addition interface, as shown in Figure 2-26. After setting, click OK to finish adding the barcode. , As shown in Figure 2-27.

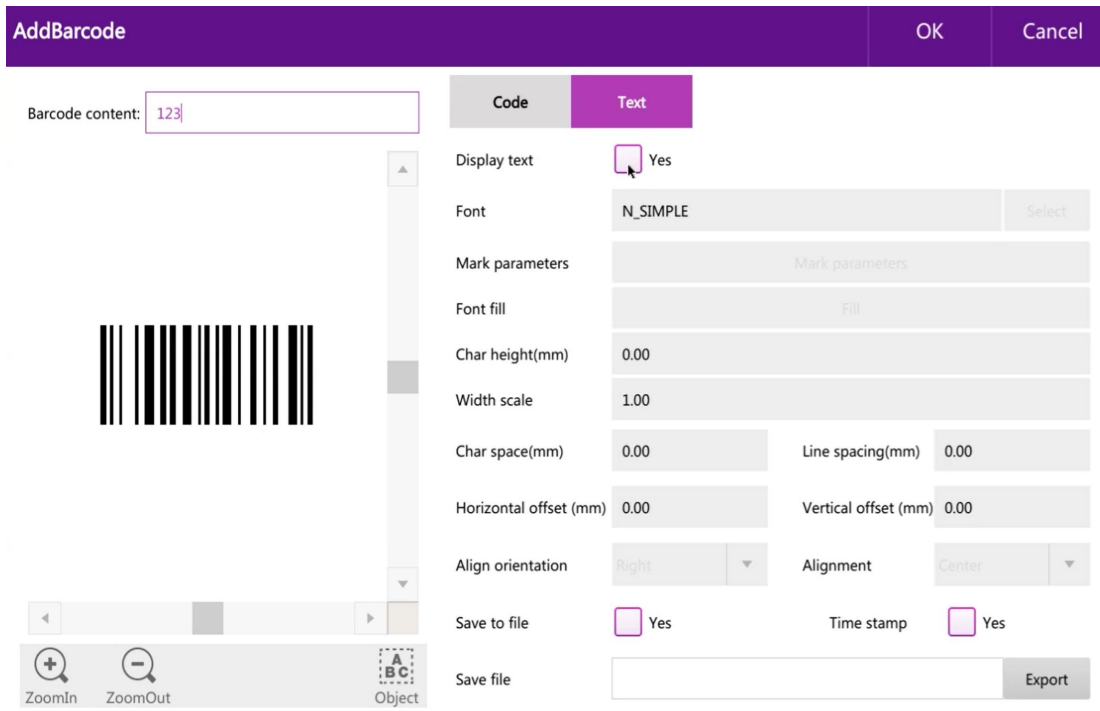


Figure 2- 25

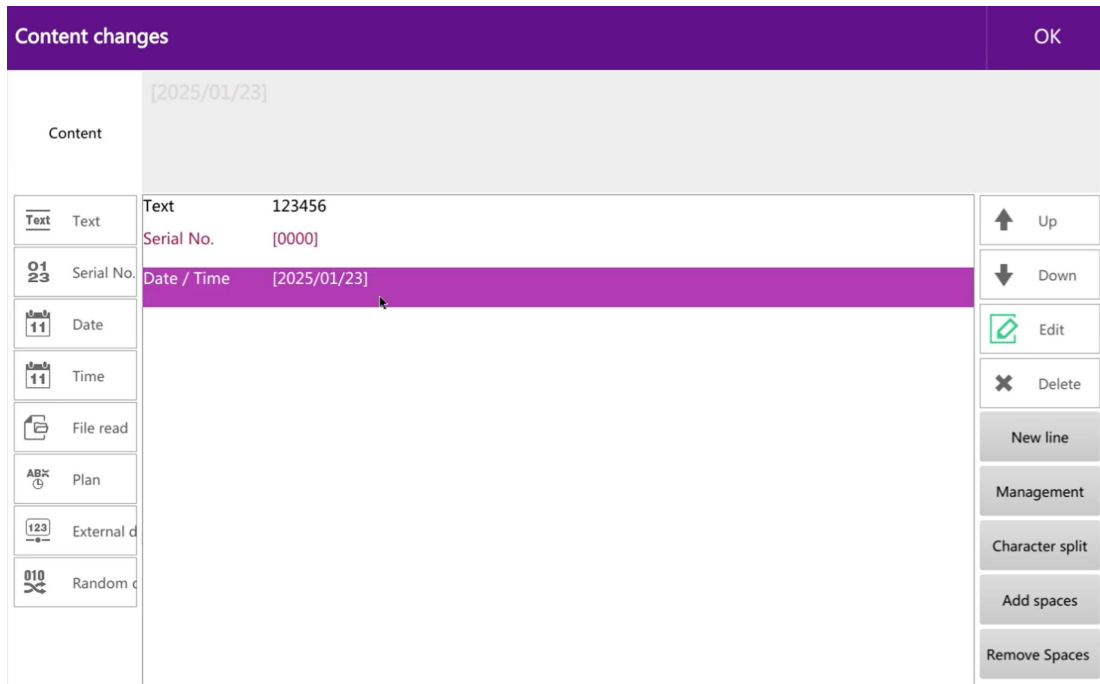


Figure 2- 26

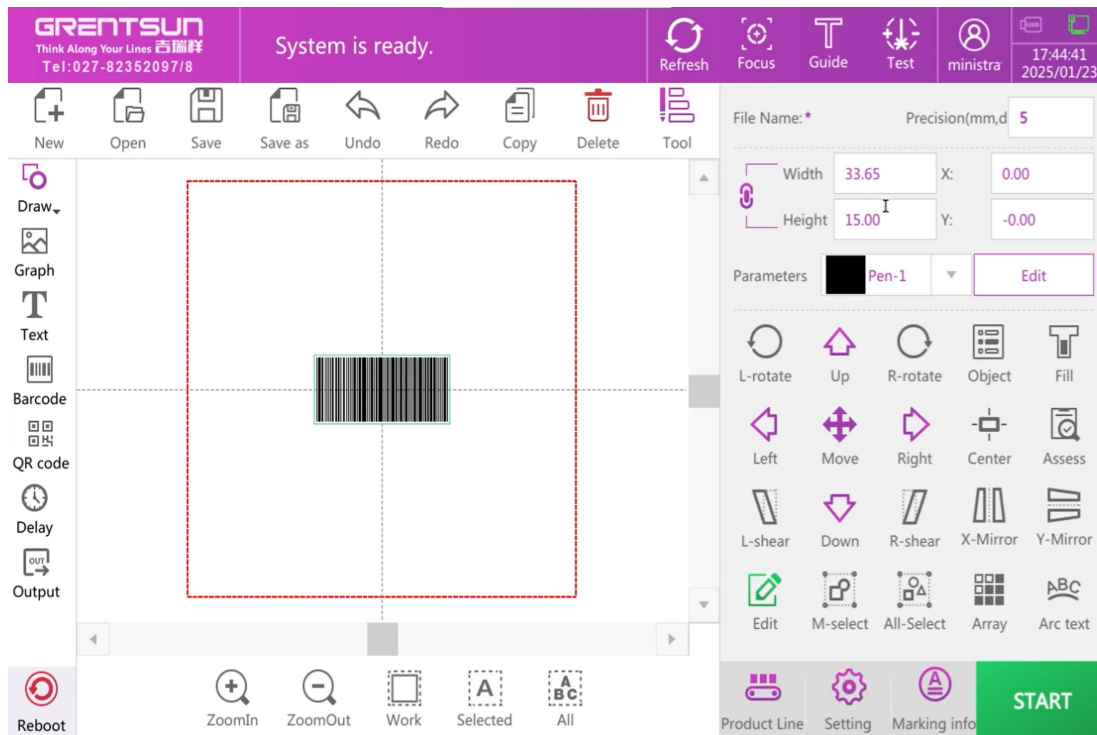


Figure 2- 27

**Fill type modification:**Click Fill to enter the fill type modification interface. Fill types include points, lines, circles, and normal. As shown in Figure 2-28.

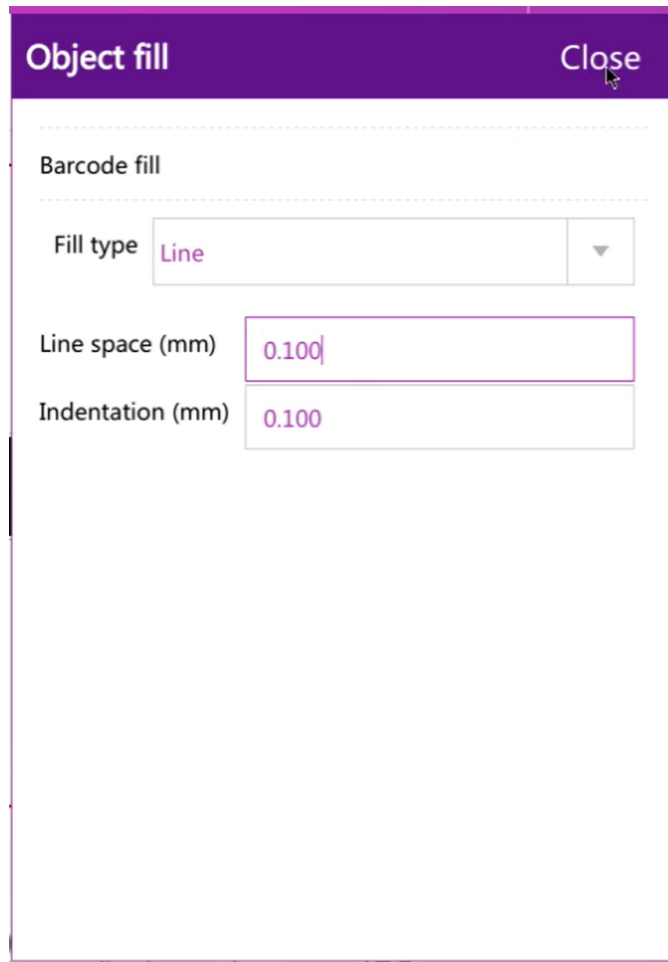


Figure 2- 28

### Line fill

Fill type selection line, you can modify the line spacing or indent.

### Normal fill

Select the normal filling type, as shown in Figure 2-29, click Enable Filling, you can modify the filling angle, fill line spacing, and whether to enable the border.

#### Filling type:

Optimize line filling: line filling is zigzag

Ordinary line filling: fill the line and move the pen up and down

**Other parameters:**Modify the filling details, as shown in Figure 2-30.

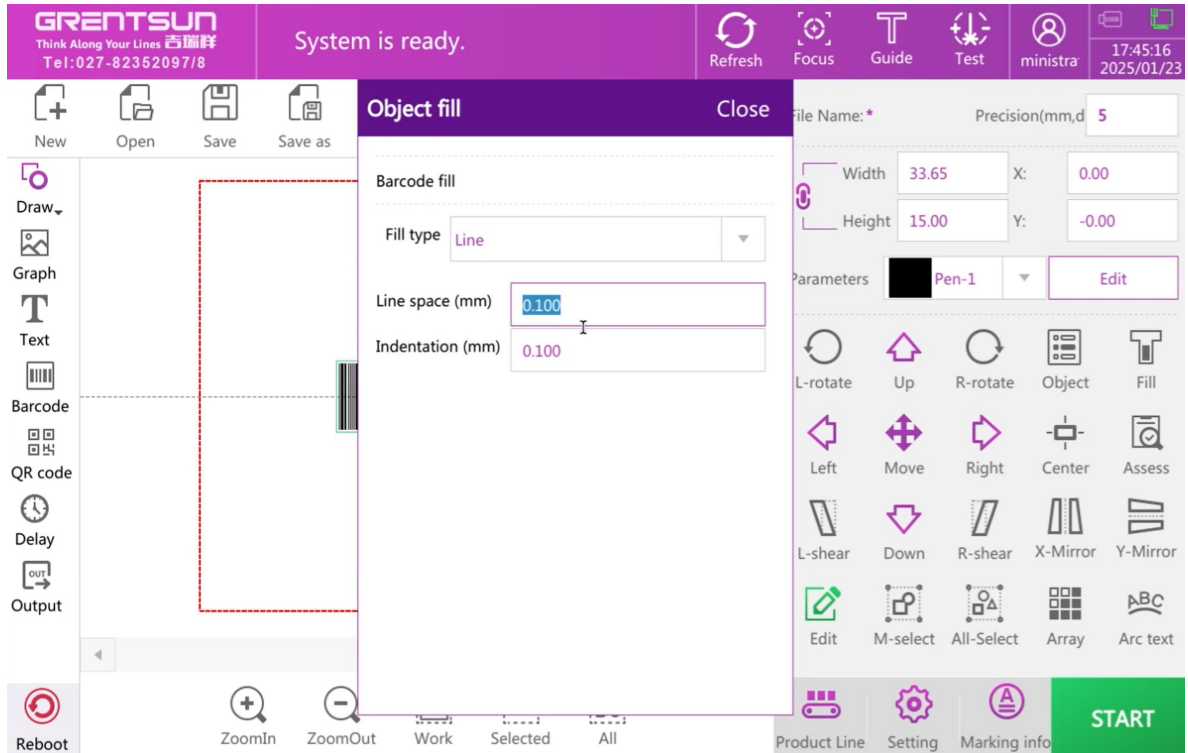


Figure 2- 29

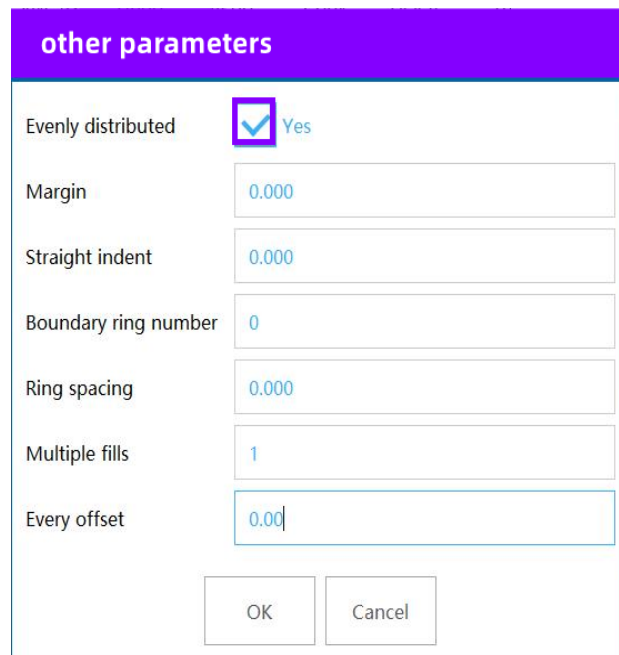


Figure 2- 30

**Margin:**Distance between filled line and enabled frame.

**Straight indent:**Distance between straight line and enabled frame.

**Boundary ring number:**Number of borders

**Ring spacing:**Distance between frame and frame

**Multiple fills:**Filling times

**Every offset:**The previous and next offset angle

### 1.3.6. Add QR code

Click the QR code button on the homepage to enter the QR code editing interface. The default content is 123 QR code, as shown in Figure 2-31.

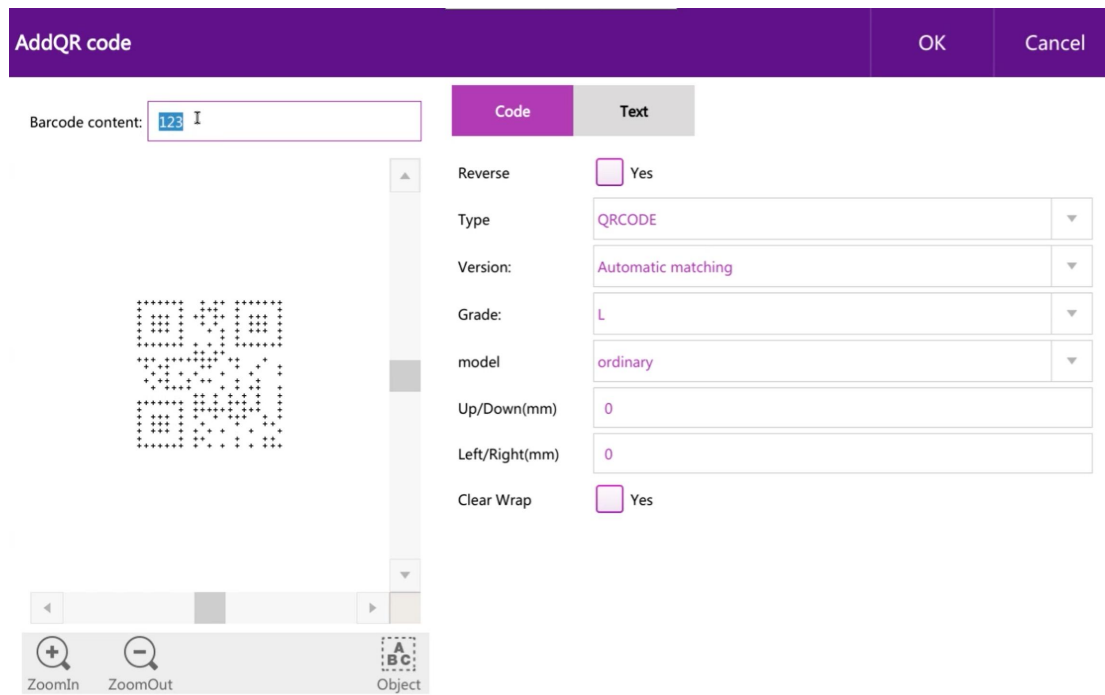
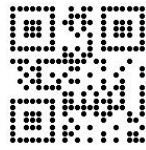


Figure 2- 31

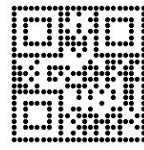
#### Code

**Reverse:**After ticking, the QR code will be reversed. After the reverse, the surrounding borders are generally added, that is, the upper and lower borders, and the left and right borders are changed to 1. The

comparison is as follows:



( Forward )



( Reverse border )

If the contrast is not enough, you need to reverse the barcode and add a frame. Example: White cover hits black ,The QR code does not need to be reversed, and the brown-yellow cover needs to be reversed and framed, as shown below.

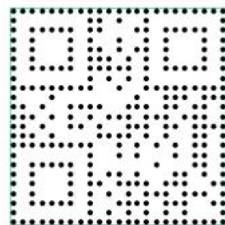


**Type:**Available types: QR CODE, PDF417, DATAMATRIX

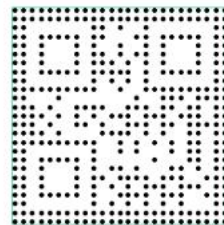
**Version:**QR code version size

**Grade:**QR code error correction level

**Frame:**The width of the filled border. Example: 1 is 1 unit border, 2 is 2 unit borders, as shown below



1 unit border



2 unit border

## Text

**Display text:**Show QR code content

**Font:**Select QR code content font

**Char height:**Character height

**Char space:**Character space

**Horizontal offset:**The horizontal offset of the text content

**Vertical offset:**The vertical offset of the text content

Save to file, timestamp, save the file as a record, usually not used

**Modified content:**Click the content box behind the text to enter the content addition interface, as shown in 2-32. After setting, click OK to complete the addition of QR code, as shown in Figure 2-33

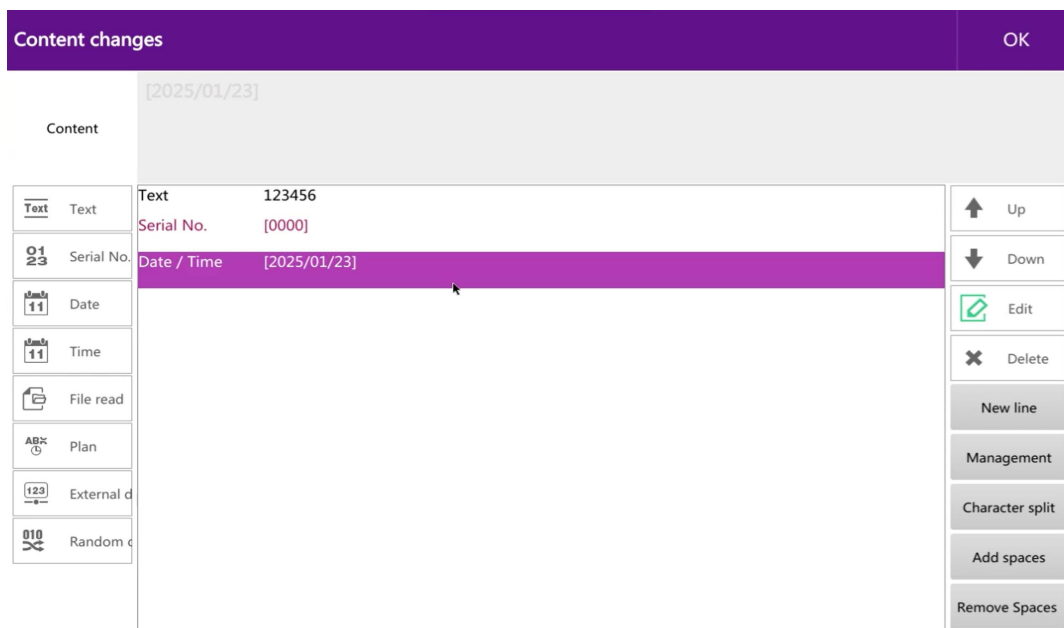


Figure 2- 32

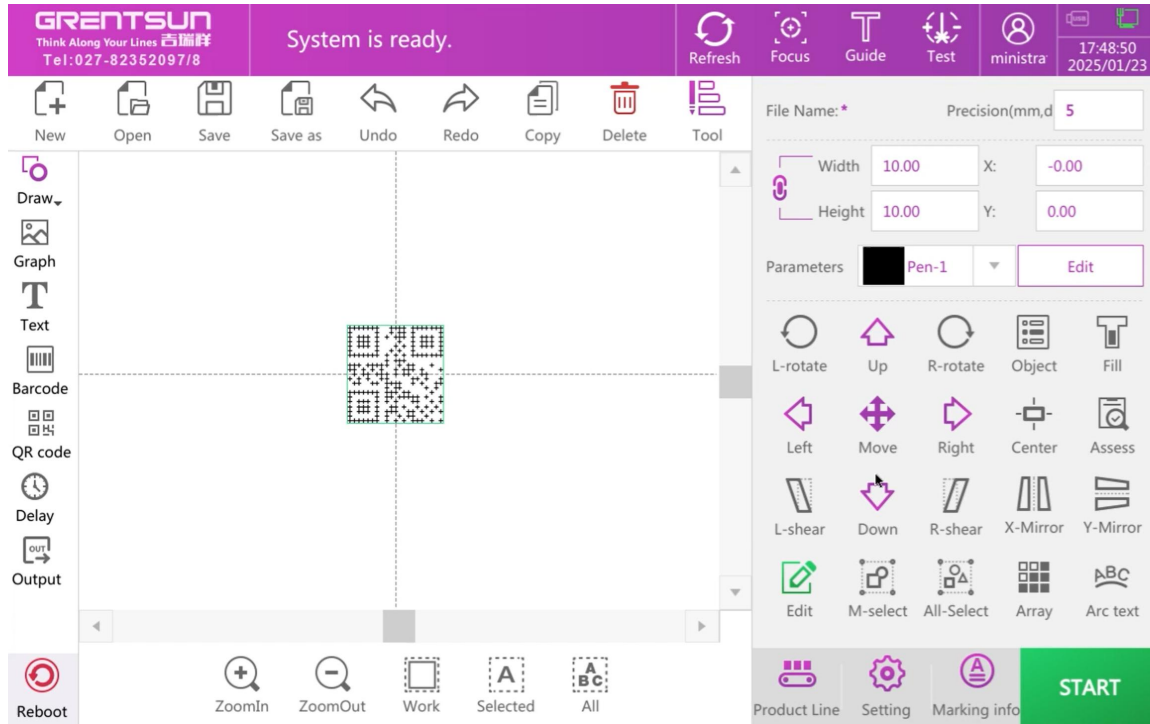


Figure 2- 33

## QR code filling

Click Fill, select the barcode filling method, as shown in Figure 2-34

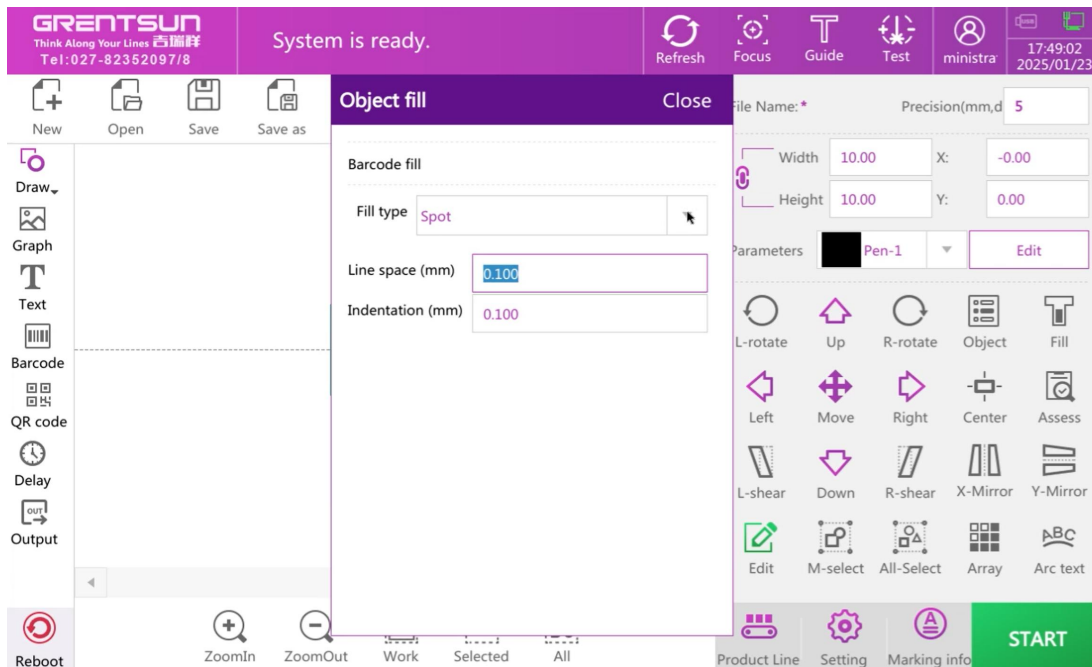


Figure 2- 34

**Fill type:** Choose the filling method of the barcode, you can choose

points, lines, circles or ordinary.

**Point fill:**

Add a QR code with the content (ABCDEFGH1234567980), and select single point filling in the filling type, as shown in 2-35

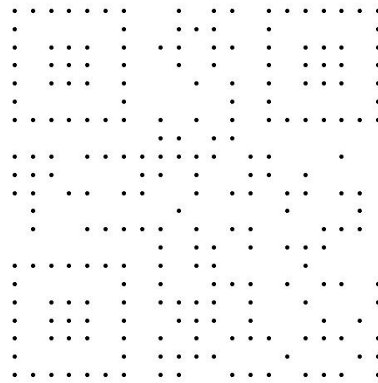


Figure 2- 35

**Line fill:**

Add a QR code with the content (ABCDEFGH1234567980) (line spacing: 0.2mm, indent: 0.1mm), select line filling in the fill type, as shown in Figure 2-36, change the spacing or margin (line spacing: 1mm , Indent by 0.2mm), as shown in Figure 2-37.

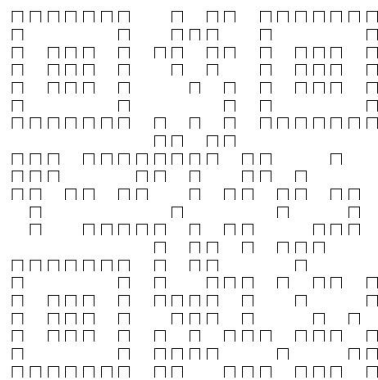


Figure 2- 36

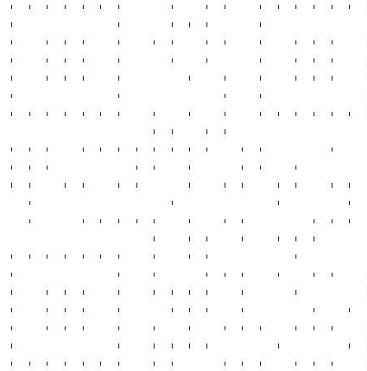


Figure 2- 37

**Circle fill:**

Add a QR code with the content (ABCDEFGH1234567980) (line spacing: 0.1, indent: 0), select the circle fill in the fill type, as shown in Figure 2-38, change the spacing or margin (line spacing: 0.5mm, Indent: 0.05mm), as shown in Figure 2-39.

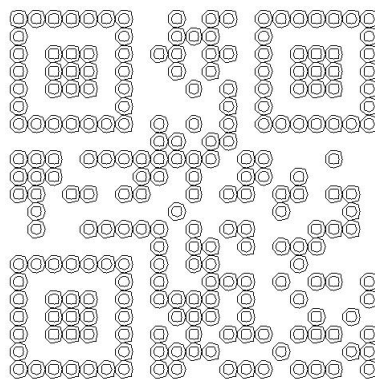


Figure 2- 38

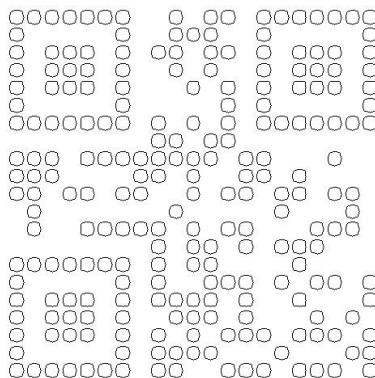


Figure 2- 39

**Ordinary fill:**

Add a QR code with the content (ABCDEFGH1234567980) in the fill type Select normal fill, as shown in Figure 2-40

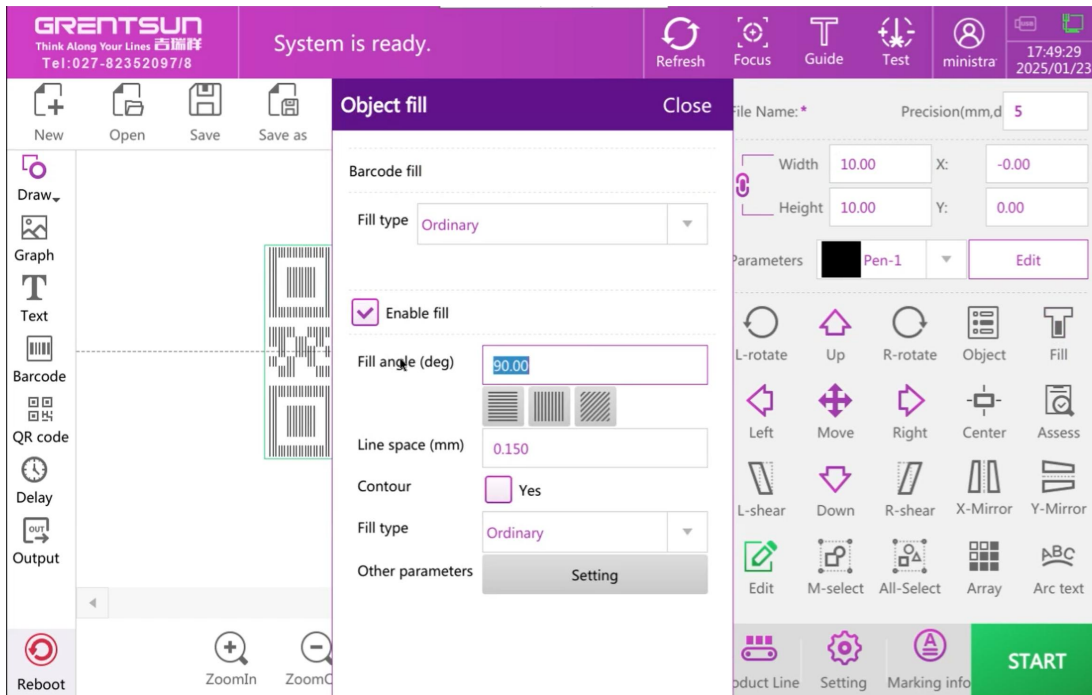


Figure 2- 40

Select Enable filling, as shown in Figure 2-41, you can change the filling angle, line spacing, whether to enable the outer frame, whether to optimize the line filling, QR code effect shown in Figure 2-42.

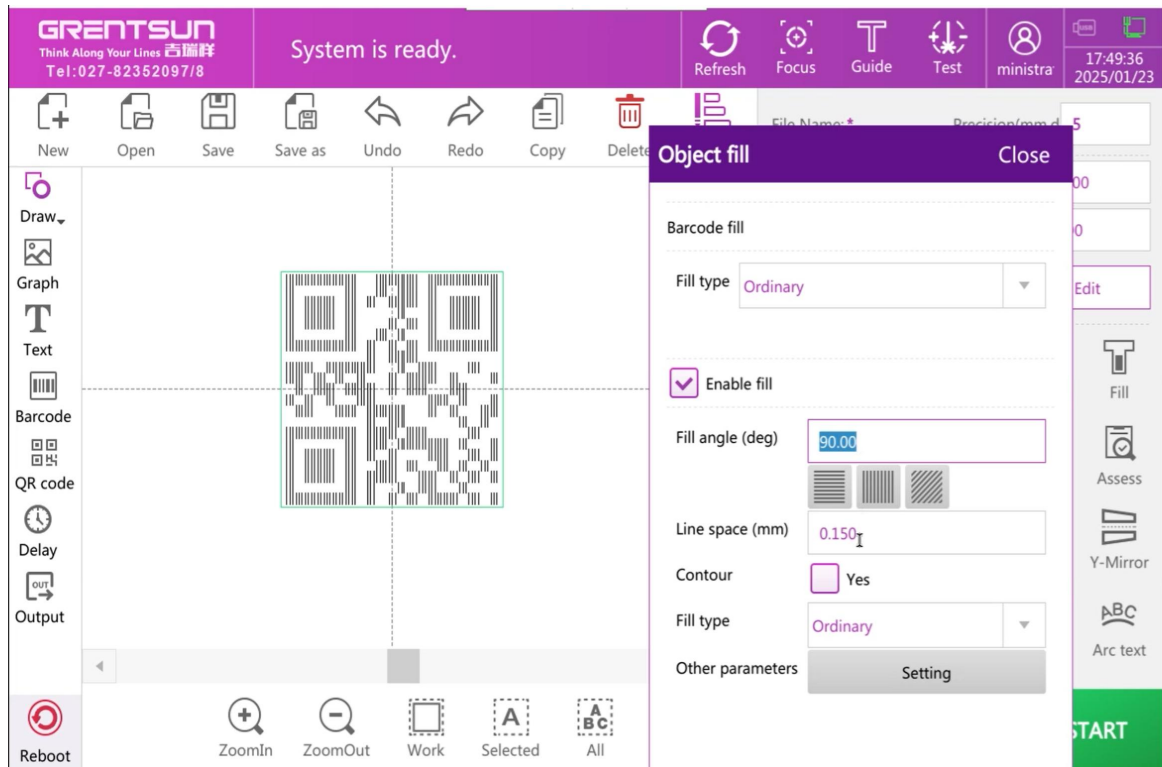


Figure 2- 41

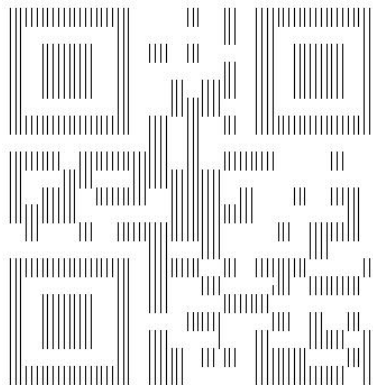


Figure 2- 42

**Fill other parameters:**As shown in Figure 2-43

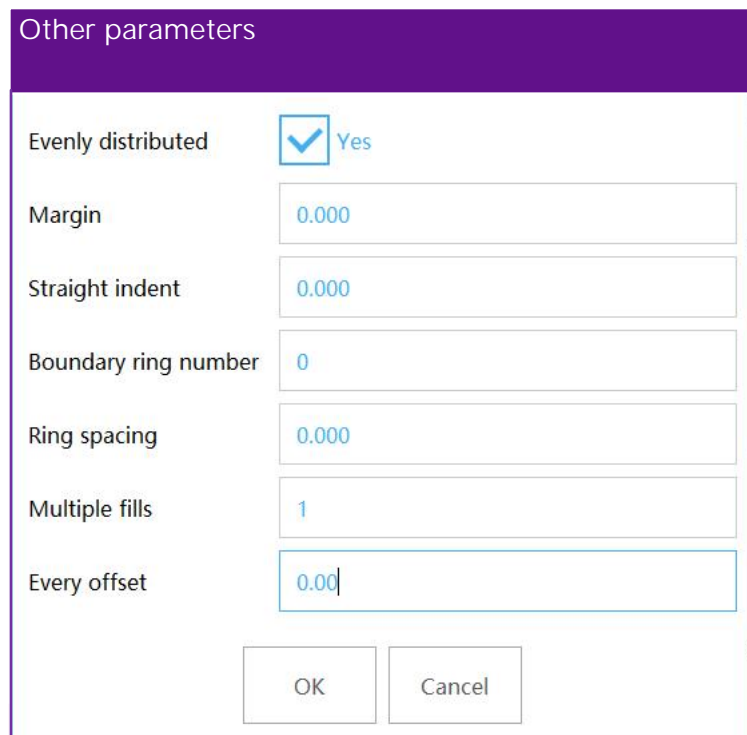


Figure 2- 43

**Margin:**Distance between filled line and enabled frame.

**Straight indent:**Distance between straight line and enabled frame.

**Boundary ring number:**Number of borders

**Ring spacing:**Distance between frame and frame

**Multiple fills:**Filling times

**Every offset:**The previous and next offset angle

### 1.3.7. Add delayer

Click the homepage delay button to pop up the editing interface, which can modify the time of the delay. This function is only effective for the static function, and the delay must be added before the marking object, and the position of the delay can be adjusted in the object list , As shown in Figure 2-44.

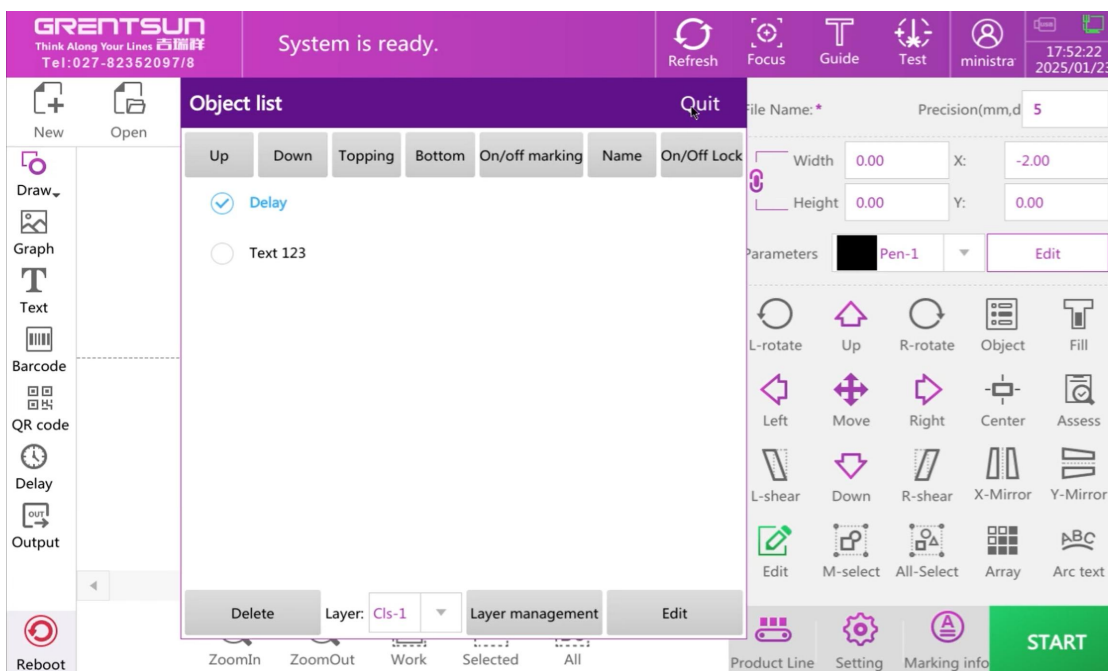


图 2- 44

### 1.3.8. New

Click the New button, it will pop up whether to save the last edited data. If you want to save, click OK, then the name of the new data file will pop up, enter the name to save the file (for example: 123), as shown in Figure 2-45.

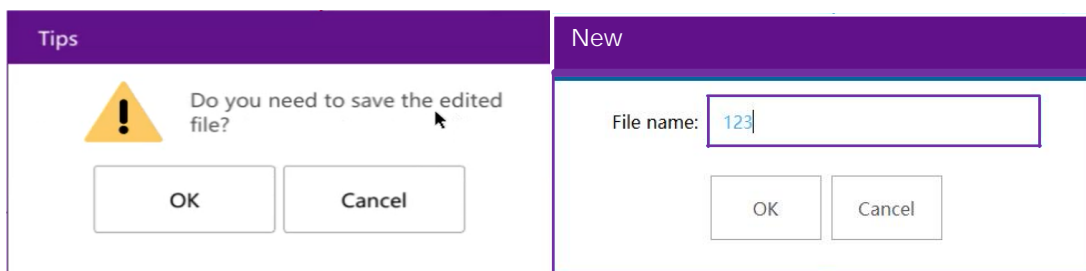


Figure 2- 45

### 1.3.9. Open

Click the Open button to open the file saved in the system internal

file or USB. If the internal file 123 is selected, click OK, as shown in Figure 2-46.

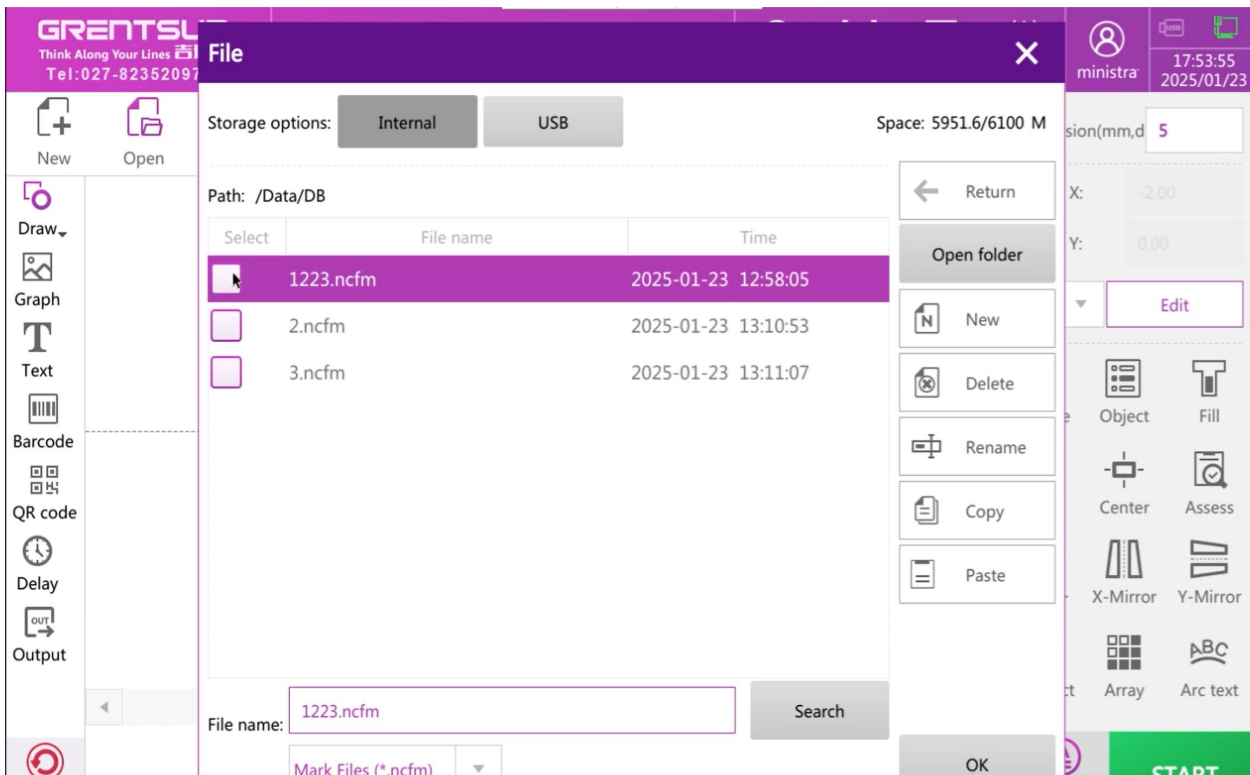


Figure 2- 46

**Return:**Return to the previous directory

**New:**Create a new file

**Delete:**Delete Files

**Rename:**Rename file

**Copy:**Copy files (you can copy the files in the USB to the system or copy the internal files to the USB)

**Paste:**Paste the copied file

### **1.3.10. Save**

Save files

### **1.3.11. Save as**

Save file

### **1.3.12. Undo**

Cancel last operation

### **1.3.13. Redo**

Perform the last undo action

### **1.3.14. Copy**

Copy the selected data, and then click the blank area to automatically paste

### **1.3.15. Delete**

Delete data

### **1.3.16. Tool**

The tool functions include: alignment, distribution, group, combination and conversion to curves and other functions

When there are multiple data, you can align the data up, down, left, right or center.

When there are more than three data, the horizontal and vertical alignment of the data can be achieved, as shown in Figure 2-47.

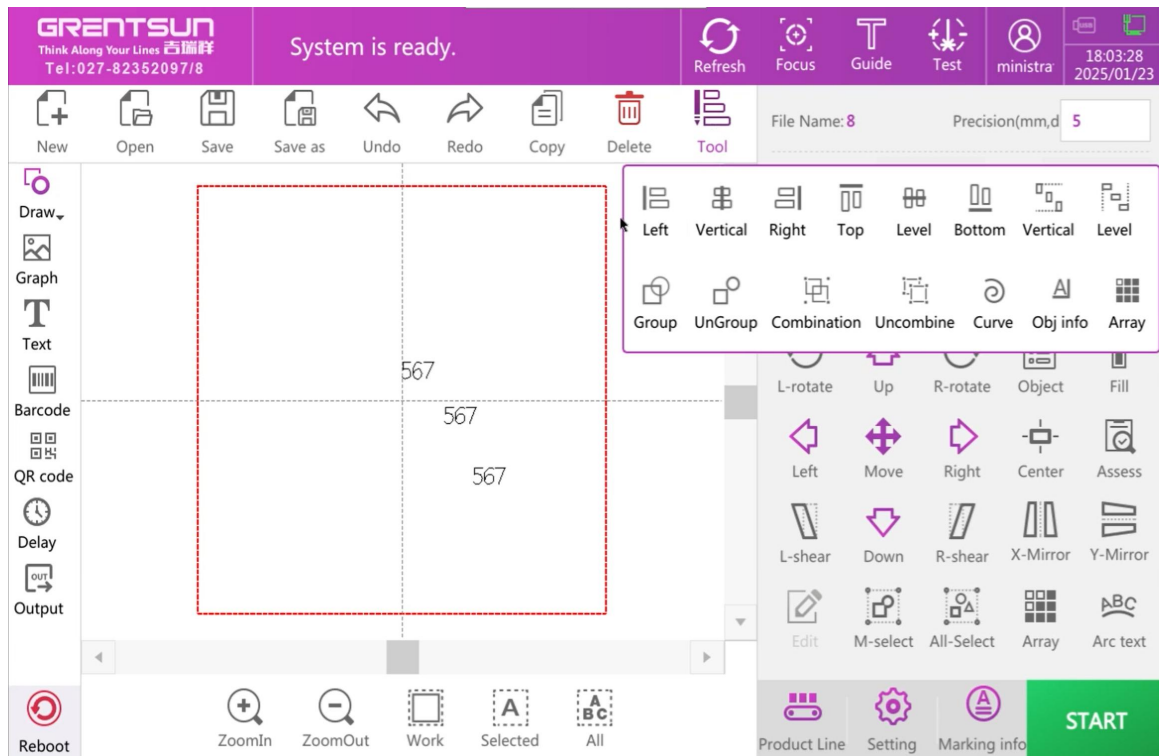


Figure 2- 47

**Group:**Two or more objects can be combined into one object

**Ungroup:**Re-separate the assembled objects

**Combination:**Combine multiple vectors

**Uncombine:**Separate vector or text content into a single vector

**Curve:**Convert text to vector

### 1.3.17. Object

The files existing in the current edit box are shown in Figure 2-48.

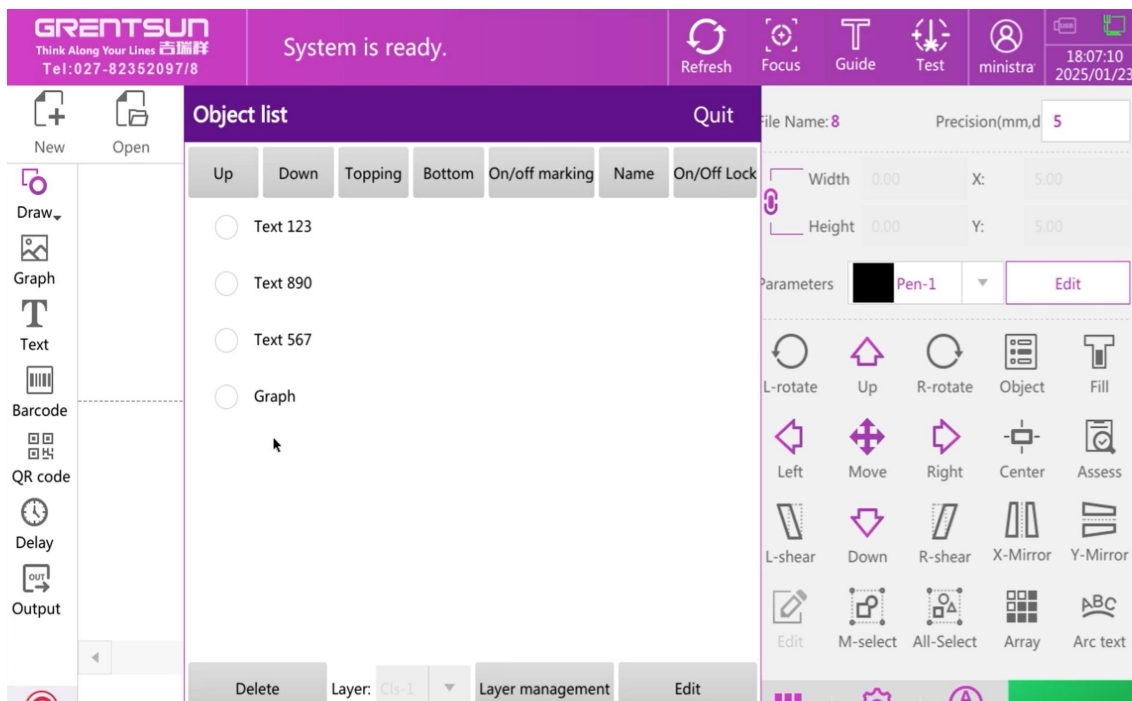


Figure 2- 48

**Up:** Move the selected object upwards, adjust the marking order of the objects, and the marking order is from top to bottom

**Down:** Move the selected object down, adjust the marking order of the objects, marking order from top to bottom

**Topping:** Move the selected object to the top

**Bottom:** Move the selected object to the bottom

**On/off marking:** The selected object can be turned on or off coding

**Layer:** If there are three pieces of data at the same time, the next piece of data can be marked after the previous one is marked, you need to add a layer, set each piece of text as a single marking layer, change the marking order, and click Manage, as shown in Figure 2-49 As shown.

Example: There are three pieces of data in the current edit box, you need to mark the previous one and then mark the next one. At this time, you

need to add three layers, each layer has a serial number, and the start delay of each layer must be set to a value , Can be set to 1. Click OK to return to the home page, as shown in Figure 2-50, each data needs to select a different layer number at the layer.

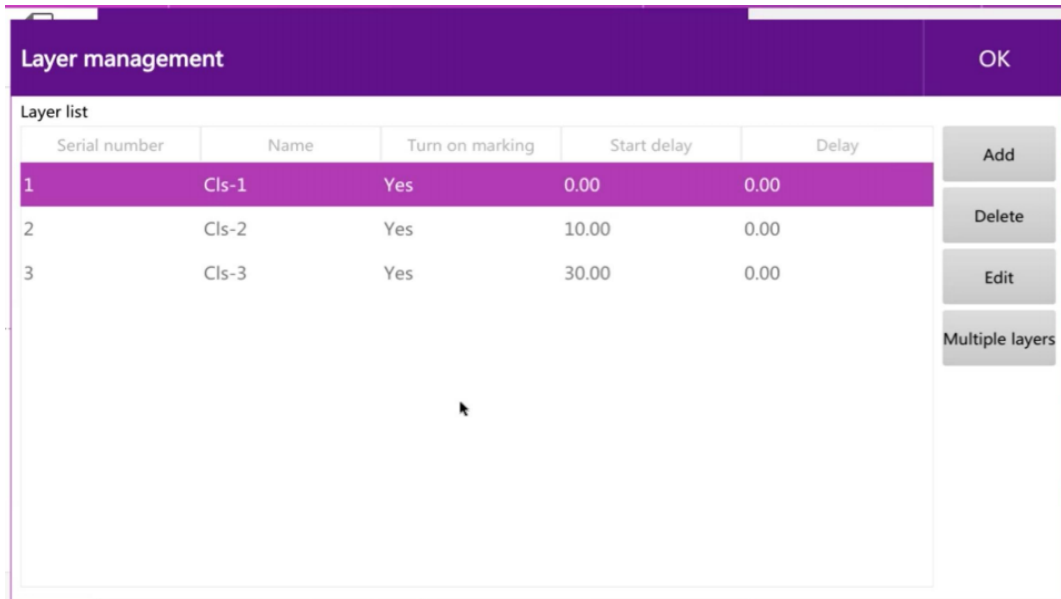


Figure 2- 49

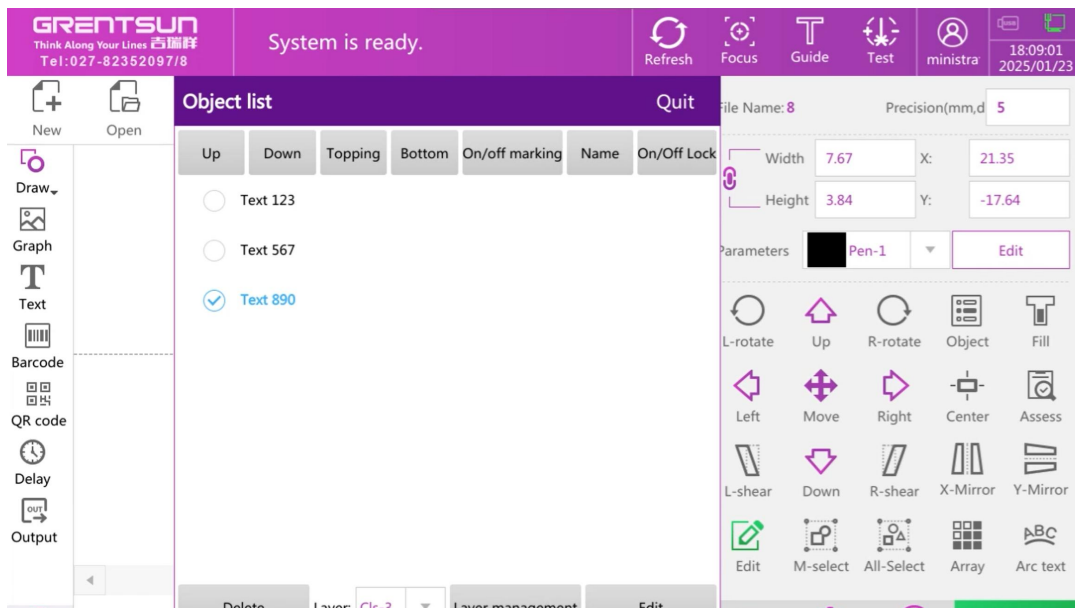
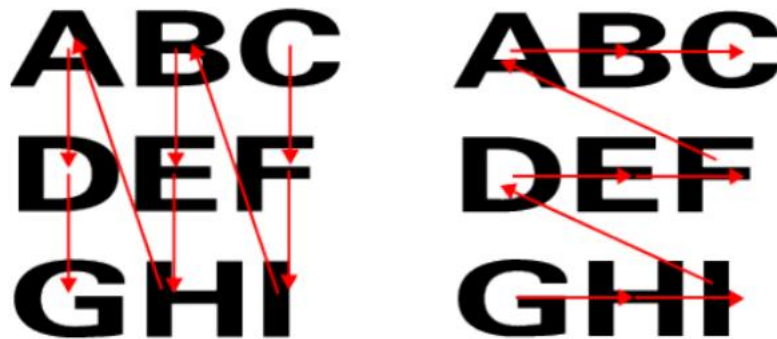


Figure 2- 50

Marking order of the same layer on the left, marking order of different layers on the right



### 1.3.18. Arc text

Click the arc text button to modify the current data into arc text, as shown in Figure 2-51. Click Yes, the data will become arc text.

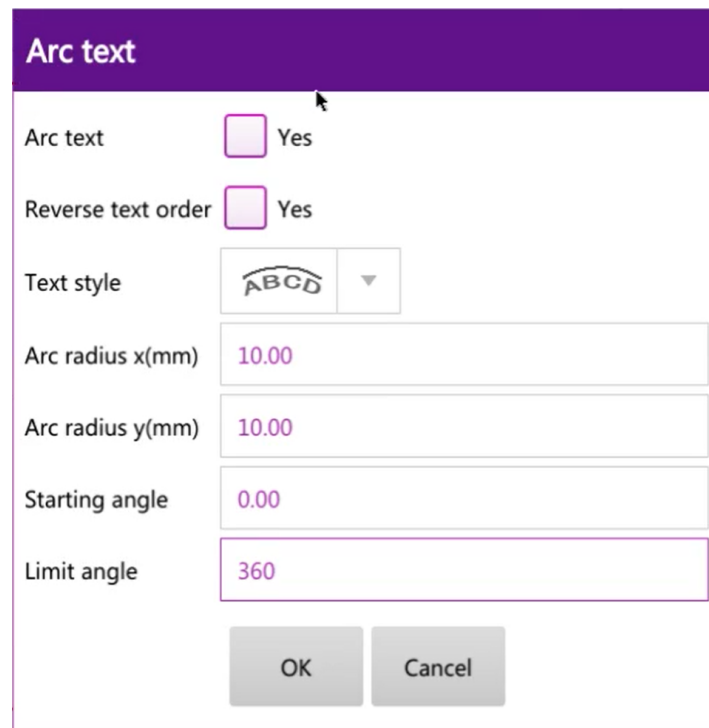


Figure 2- 51

**Reverse text order:**Text sorting direction

**Text style:**Choose according to picture

**Radius X:**Radius of arc text on X axis

**Radius Y:**Radius of arc text on Y axis

**Starting angle:**The starting angle of the first character

**Limit angle:**The angle range of the arc circle (for example, 360-degree arc-shaped text is arc-shaped text, 180-degree arc-shaped text is semi-circular arc-shaped text, as shown in Figure 2-52)

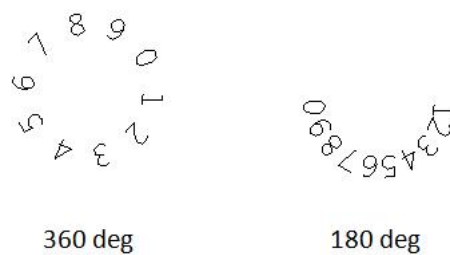


Figure 2- 52

### 1.3.19. Fill

When the font is double-lined, or when the picture is a vector diagram end to end, you can fill it, as shown in Figure 2-53.

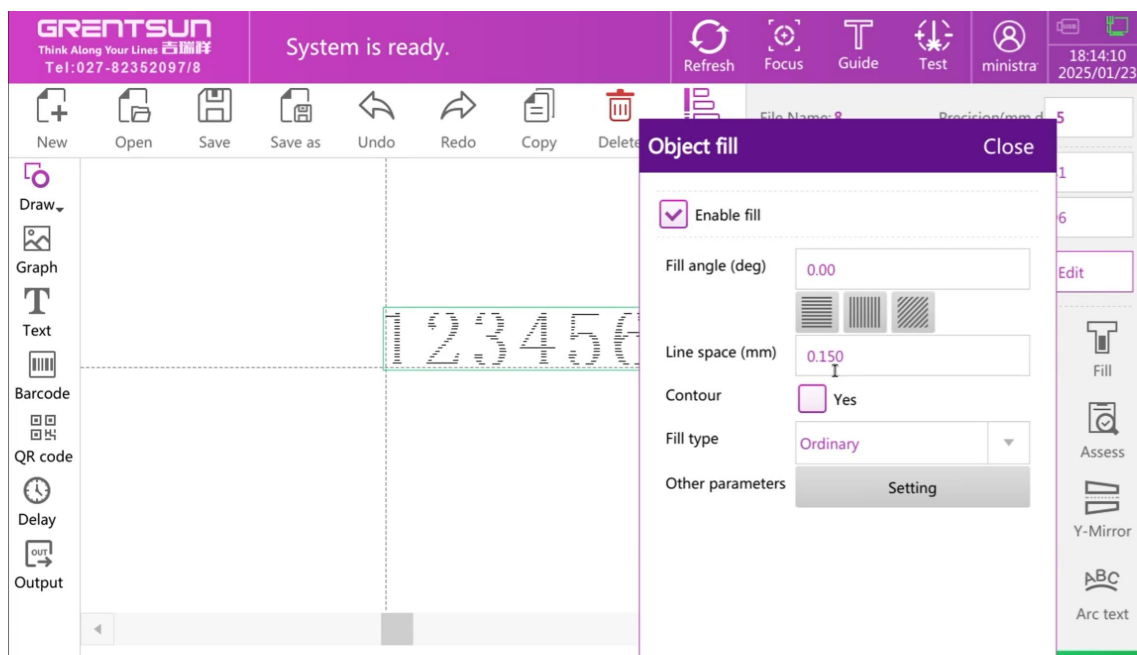


Figure 2- 53

**Enable fill:**After selected, it can realize graphics or font filling

**Fill angle:**The angle between the line filling and the X axis, you can choose the graphics to quickly fill

**Line space:**Distance between filled lines

**Contour:**Whether to enable the frame

**Fill type:**Optimize line filling (to reduce the marking time), normal line filling static marking according to the direction of the arrow to mark, as shown in Figure 2-54

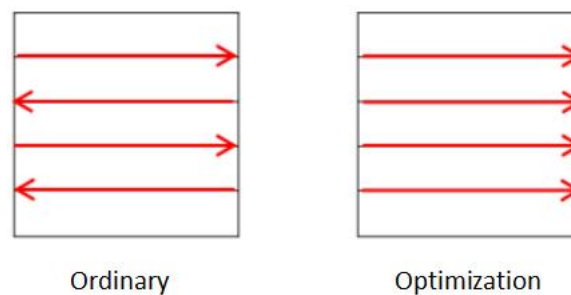


Figure 2- 54

**Other parameters:**As shown in Figure 2-55

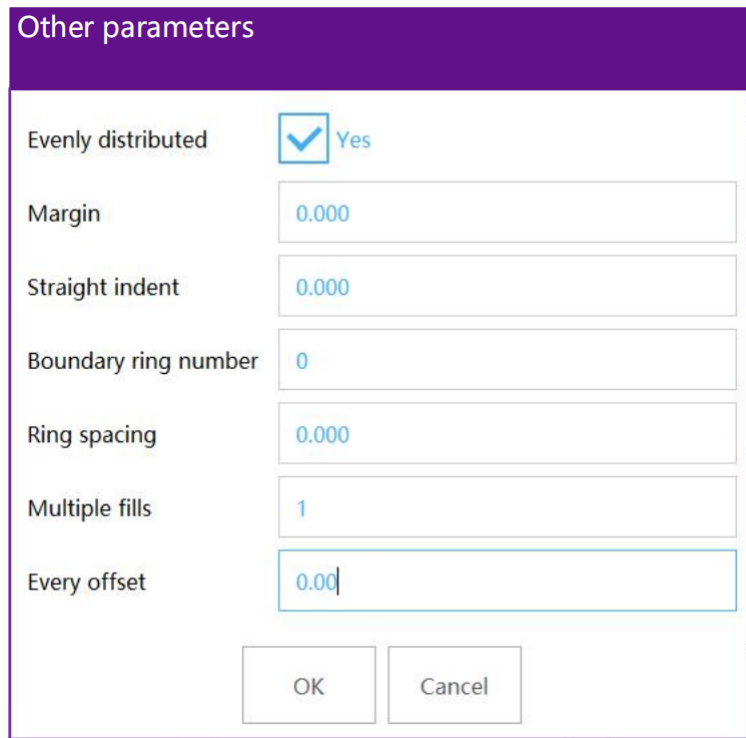


Figure 2- 55

**Margin:**Distance between filled line and enabled frame.

**Straight indent:**Distance between straight line and enabled frame.

**Boundary ring number:**Number of borders

**Ring spacing:**Distance between frame and frame

**Multiple fills:**Filling times

**Every offset:**The previous and next offset angle

### 1.3.20. Array

Arrange the objects in an array, as shown in Figure 2-56, you can set the number of X/Y directions and the distance between them. After setting, click OK to confirm as shown in Figure 2-57

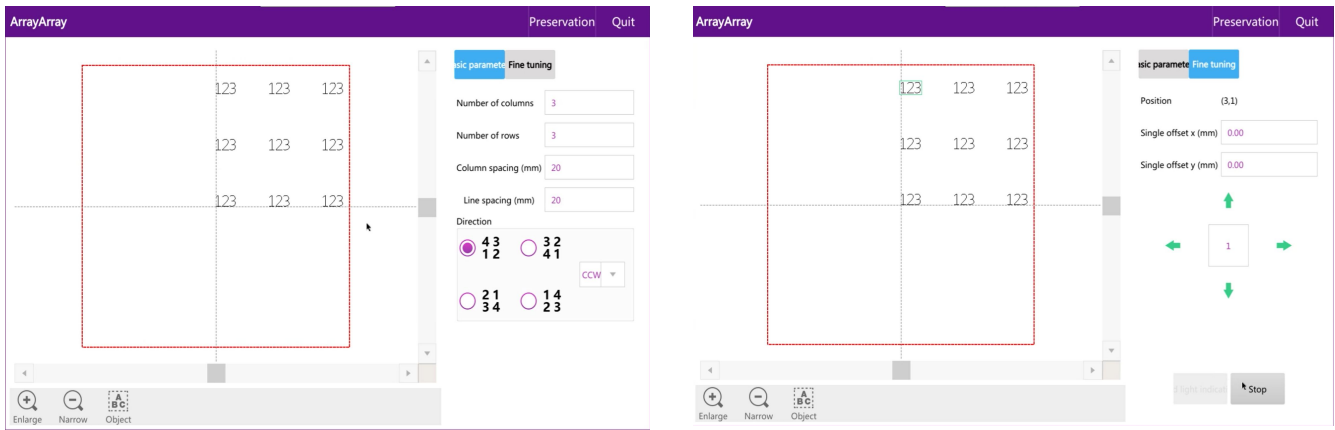


图 2- 56

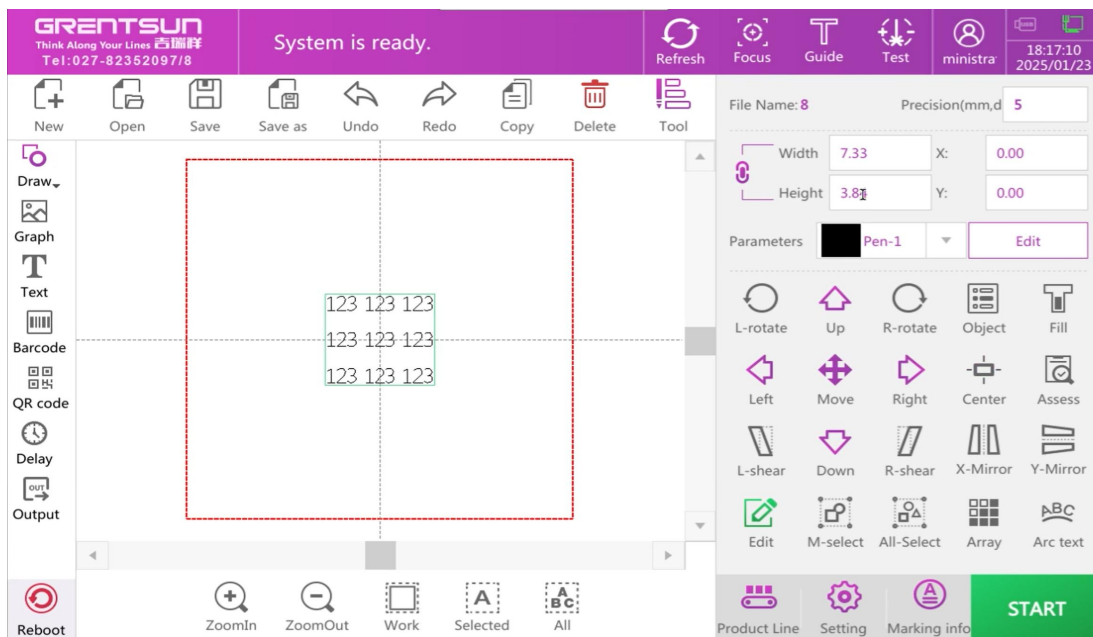



Figure 2- 57

### 1.3.21. Marking parameters

Select the color block corresponding to the marking parameters. The marking parameters can be modified in the setting function-----spraying parameters. Different text can choose different color blocks, and the

same color block can also be selected.

### 1.3.22. Dimensions and coordinates

Modify the text size and text coordinate position, as shown in Figure 2-58, click the associated button to modify the width or height individually 

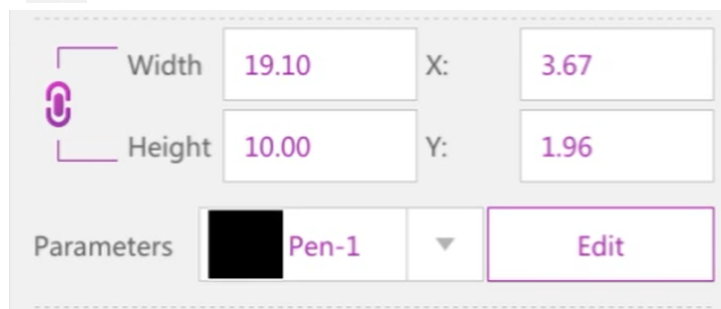
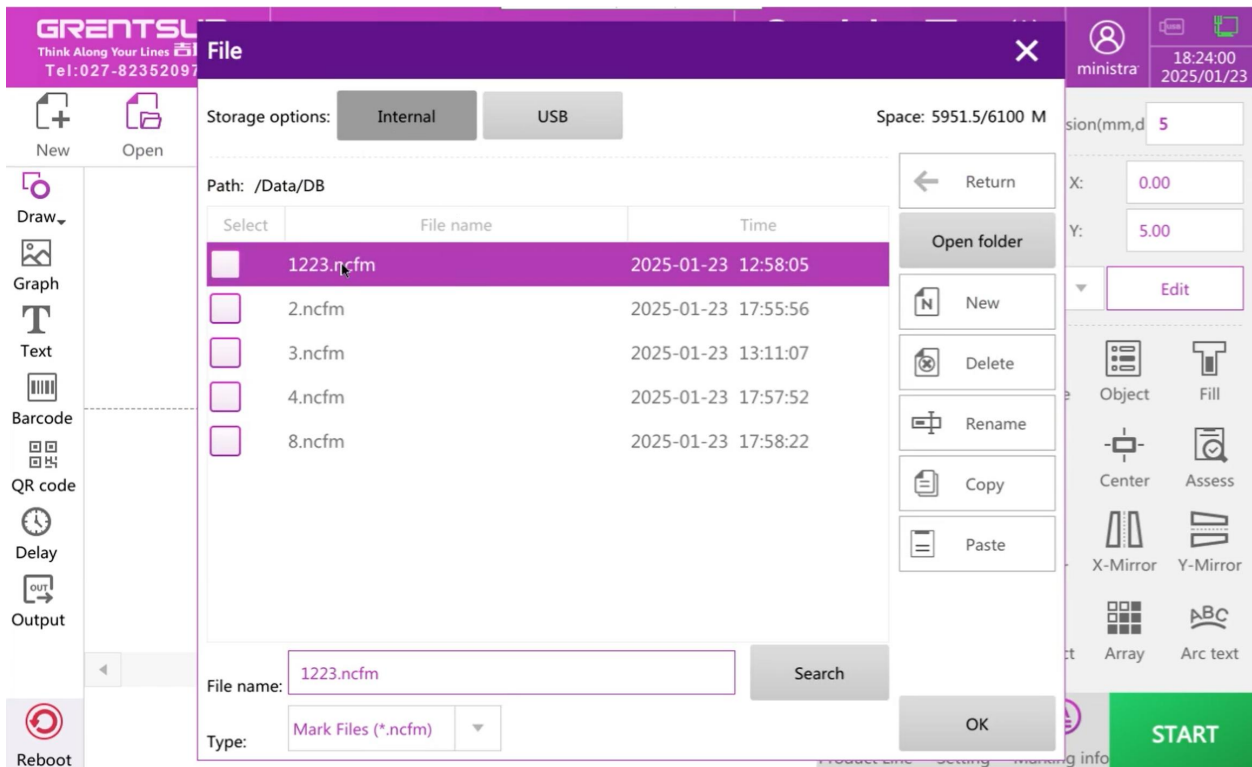


Figure 2- 58

### 1.3.23. Document management

**Document management:**Manage spray files and fonts, as shown below



## Marking file management

You can copy the files saved in the system to the U disk, and you can also copy the files in the U disk to the system.

How to use: 1. Click inside, select the file, and click Copy

2. Click USB, click Paste, the system internal files are successfully copied to the U disk

## Font management

Users can upload fonts to the inside of the system, support upload format: ttf font format,

How to use: 1. Insert the U disk with TTF font format into the USB

socket

2、 Click the font, then USB, click the font on the upper right, Select the double-line font, click USB again, then select the TTF font and click the import button

3、 After the system prompts that the font is successful, restart the system

## 1.4. System toolbar



**Document:**Manage spray files and fonts

**ZoomIn:**Zoom tool

**ZoomOut:**Zoom out tool

**Work:**Show the entire marking area

**Selected:**Maximize display of selected objects

**ALL:**Maximize all objects

## 2. Keyboard introduction

The keyboard interface is shown in Figure 2-59

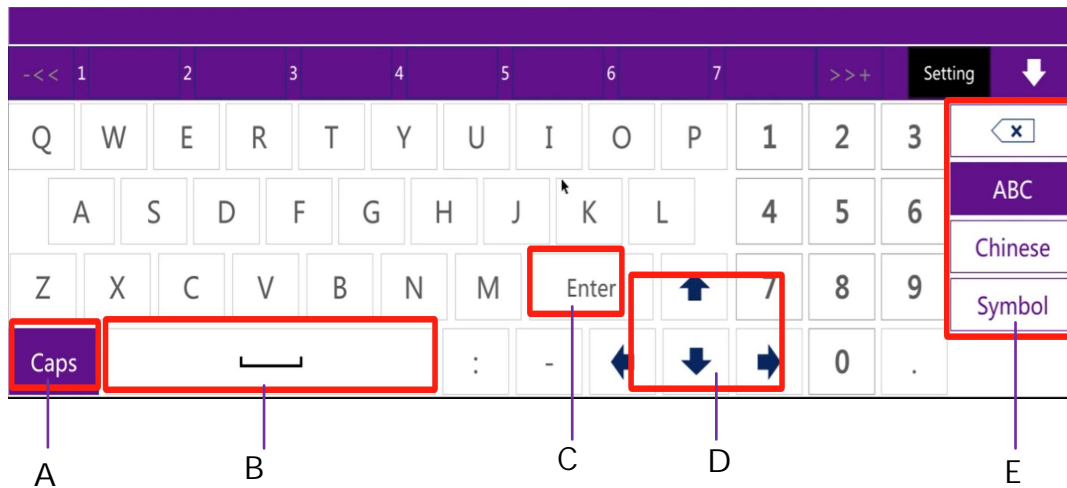


图 2- 59

**A:** Capitalization switch

**B:** Space bar

**C:** Newline key

**D:** Cursor up, down, left and right

**E:** Delete, input method switch, close (Note: Chinese is Pinyin input)

## 3. Production line settings

### 3.1.1. Static coding settings

#### 1、 Pipeline settings

The direction of the pipeline is selected to be stationary, as shown in Figure 3-1

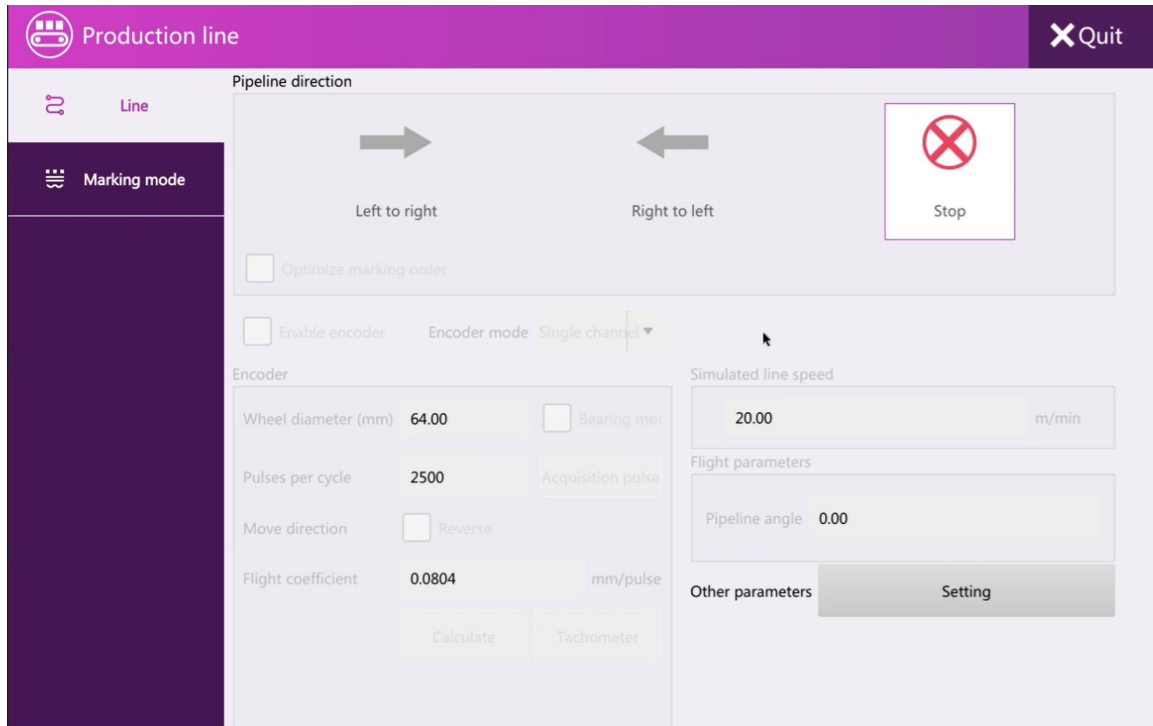


Figure 3-1

## 2、 Marking mode settings

Marking mode can choose jog mode or signal trigger mode.

### 3.1.1.1. Jog mode

Marking mode is changed to jog mode, as shown in Figure 3-2.

**Pedal Mode:**When the mode is jog mode, the pedal mode can be selected as the trigger signal, and the foot filter can be set. After clicking to start marking, wait for the foot signal before marking.

**Cont. Mode:**When checked, click once to start marking and continuous marking according to the time interval. When not checked, click once to start marking once.

**Red light mode:**After marking, the red light guide runs automatically.

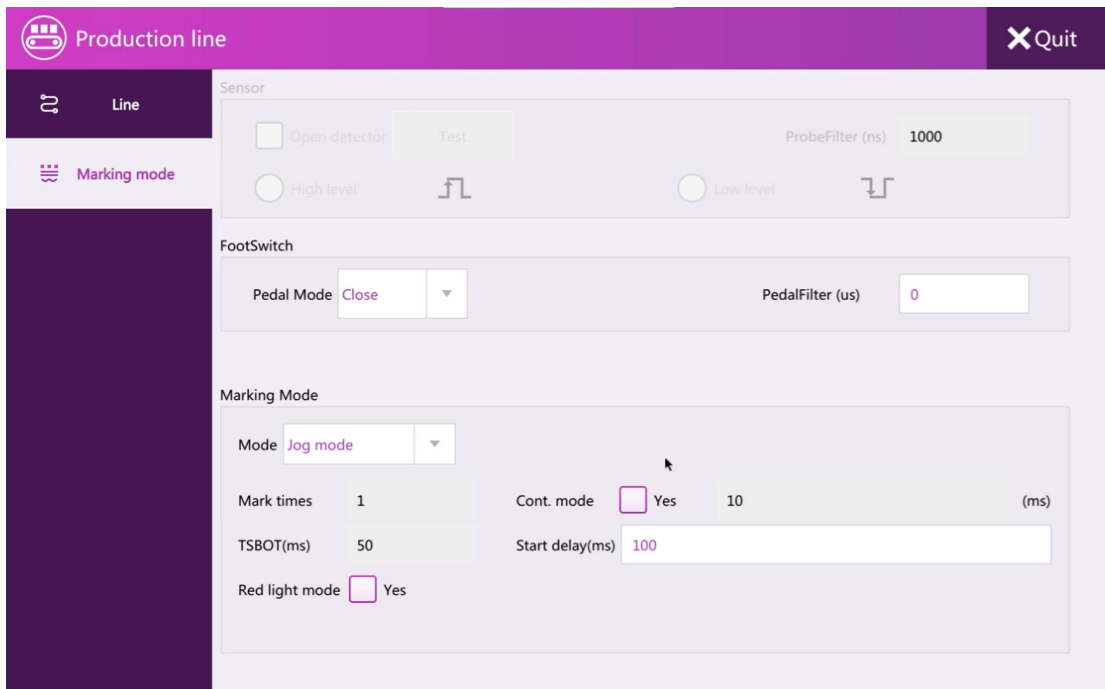


Figure 3- 2

### 3.1.1.2. Trigger marking mode

Marking mode selects the sensor mode, as shown in Figure 3-3. In this mode, the sensor must be turned on, otherwise no trigger signal will be received. In this mode, the foot switch will not take effect.

**Open detector:** Must be checked, otherwise the trigger signal cannot be received without marking, and the sensor filter can be set.

**Level setting:** Select the level trigger polarity (high level or low level trigger)

**Mark times:** After clicking to start marking, the sensor triggers a signal and the system performs several markings.

**TSBOT:** Within the set time, the system will automatically shield the trigger signal received by the sensor.

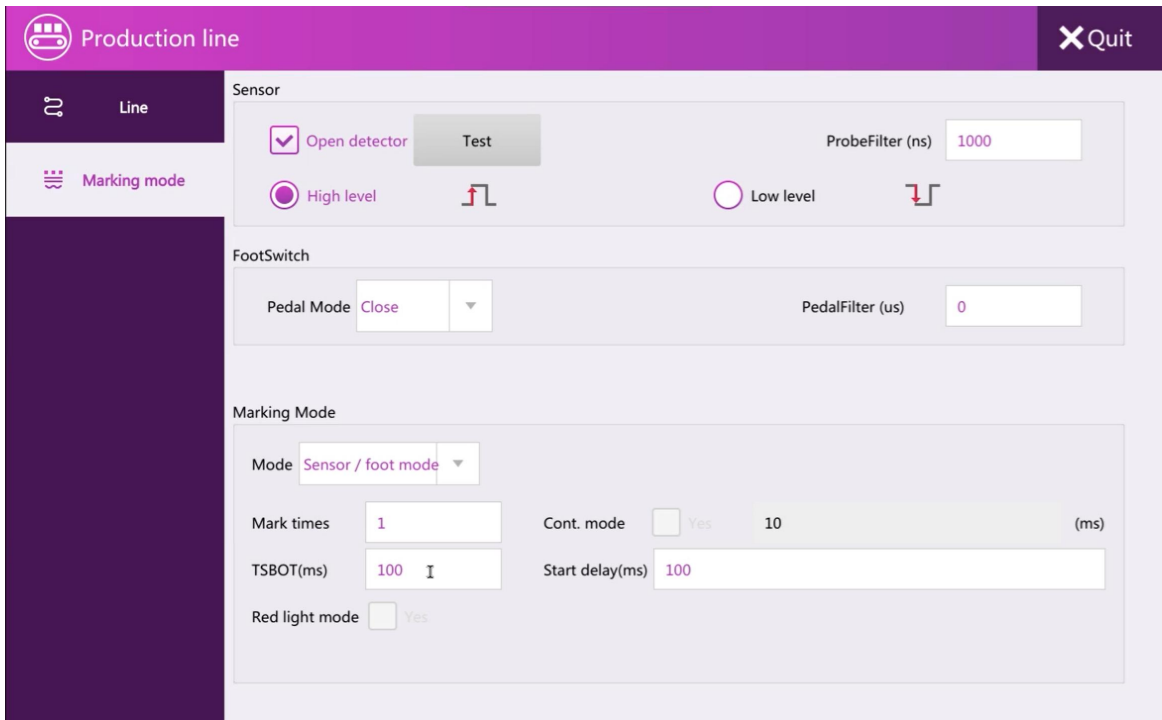
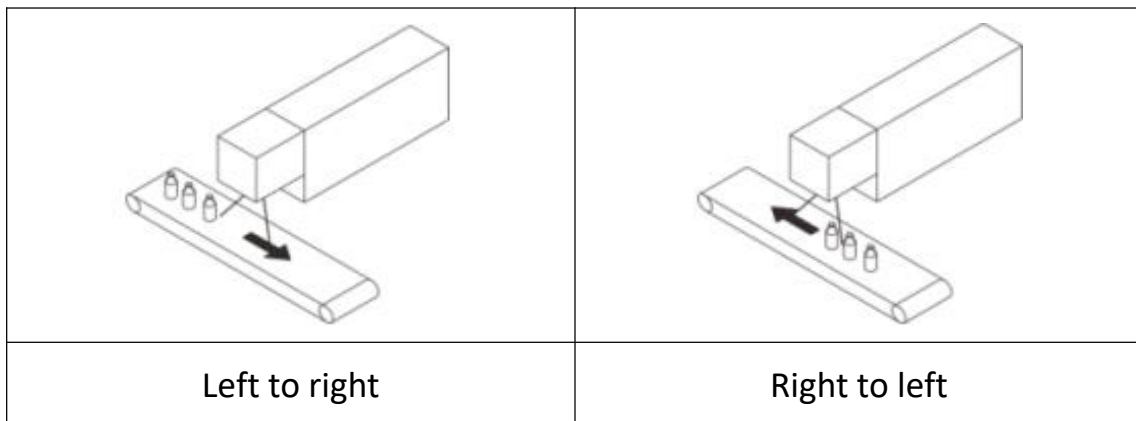


Figure 3-3

### 3.1.2. Flight marking settings

The direction of the pipeline is selected from left to right or from right to left, according to the situation of on-site coding, as shown in Figure 3-4.



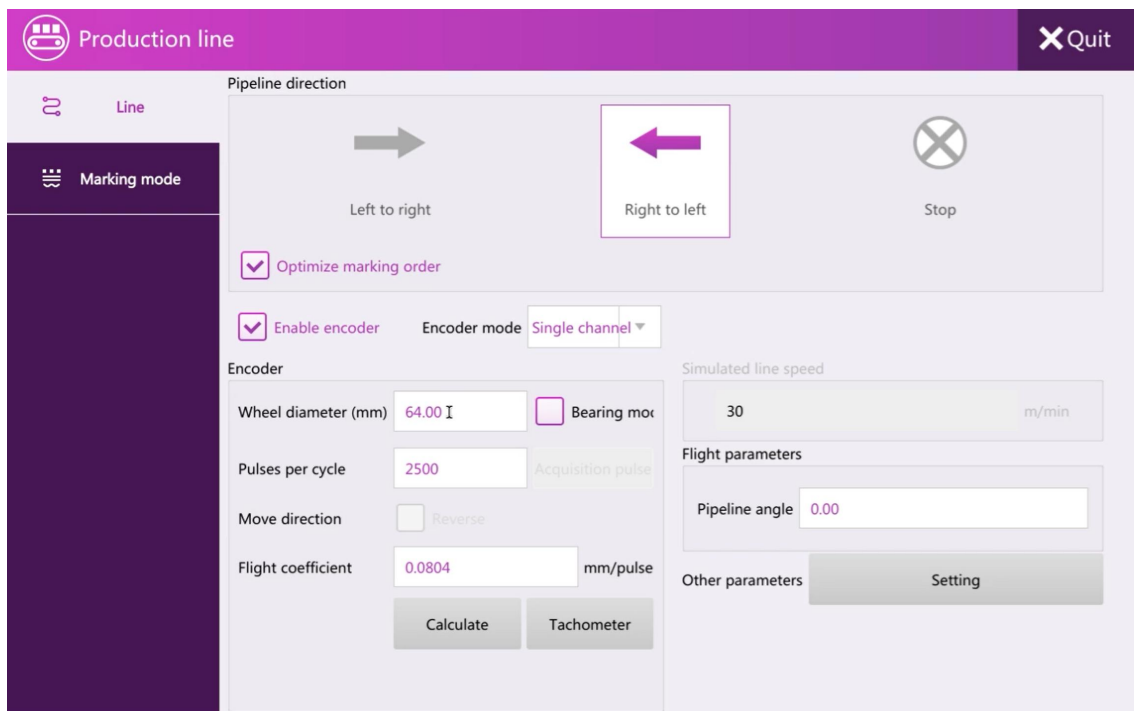
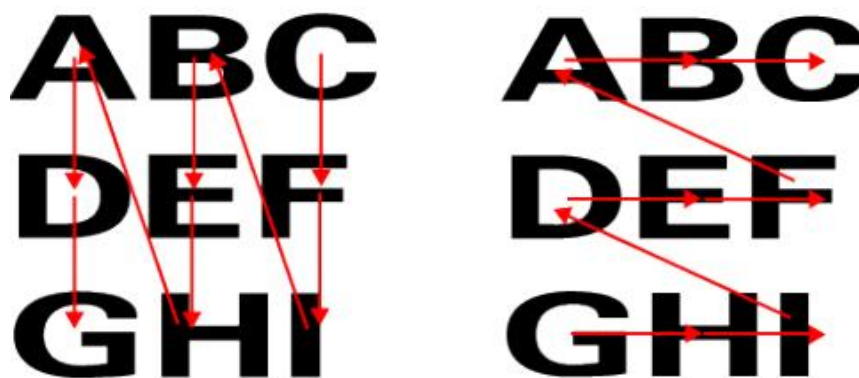


Figure 3-4

**Optimize marking order:**The comparison between optimized coding order (left) and non-optimized (right) is as follows.



**Enable encoder:**When checked, the encoder is used to mark the pipeline speed simultaneously; when unchecked, it is marked with the analog pipeline speed.

**Encoder settings:**

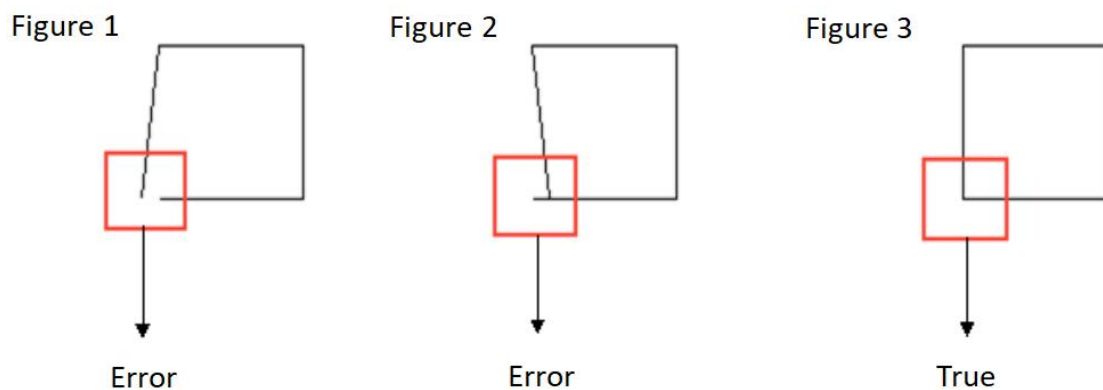
**Wheel diameter:**The diameter of the wheel mounted on the encoder.

**Pulses per cycle:**The number of encoder pulses can be obtained on

the encoder label.

**Move direction:**Click to calculate the coefficient and speed to automatically identify whether to run in reverse

**Flight coefficient:**Click the calculation coefficient to automatically obtain the flight marking coefficient (this value is the calculated value, fine-tuned according to the marking effect on site).



When the situation in Figure 1 or Figure 2 occurs, increase or decrease the coefficient according to the on-site laser placement direction and the pipeline direction until the figure marked is shown in Figure 3.

**Pipeline angle:**The angle between the laser and the pipeline, when the laser machine and the pipeline have a small angle, and the physical adjustment is not accurate enough, the angle can be corrected by software modification. The pipeline angle is shown in Figure 3-5.

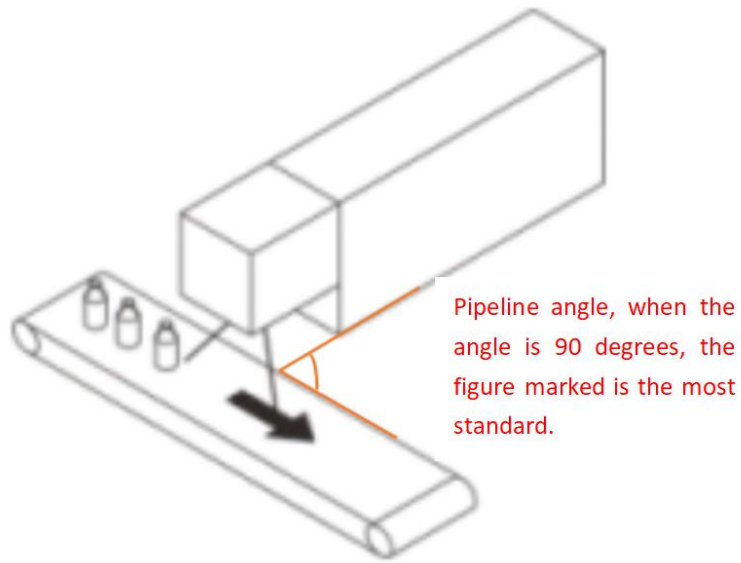


Figure 3- 5

If the angle is incorrect, the following two situations will appear, as shown in Figure 3-6

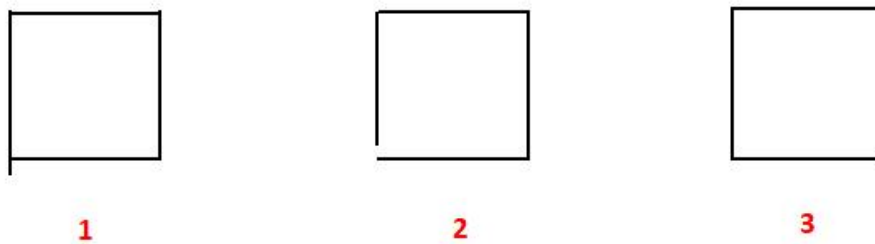


Figure 3-6

When the situation of Figure 1 or Figure 2 occurs, increase or decrease the angle of the pipeline (can be changed to a negative number) according to the direction of the laser placement on the site and the direction of the pipeline, until the marked figure is shown in Figure 3.

**Other parameter:**The interface is shown in Figure 3-7.

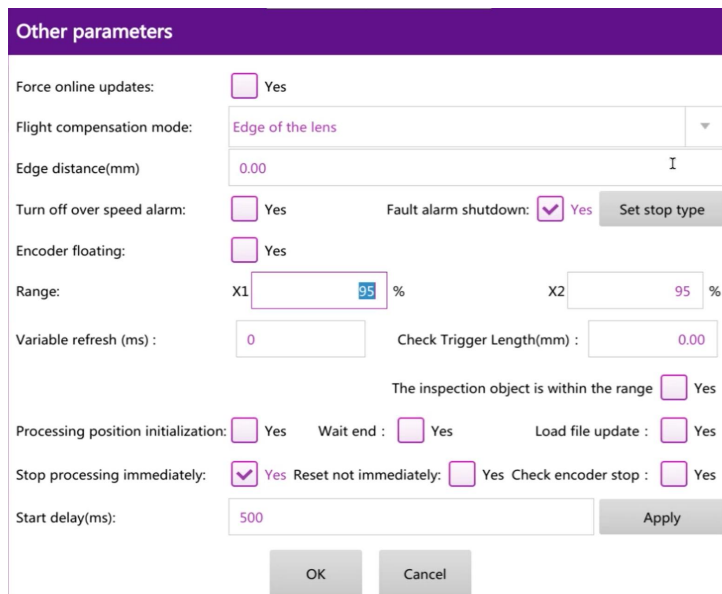


Figure 3-7

**Mandatory update:** If the current information is fixed content (excluding changes), if you want to realize the online update function, you must select "Yes" to force the update.

**Enable location restrictions:** When unchecked, the laser emits light from the edge of the galvanometer to increase the pipeline speed of the data; when checked, the laser emits light according to the position of the galvanometer where the data is located. For example: add the code content: 2020/06/28, the data is centered by default, click the calculation function, when checked, the current position of the data is allowed. The fastest pipeline speed: 133.94m/min. When not checked, the fastest line speed is obtained: 233.44m/min, as shown in the comparison below.

|  |                  |         |  |  |  |  |  |       |
|--|------------------|---------|--|--|--|--|--|-------|
|  | System is ready. | M133.94 |  |  |  |  |  | START |
|  | System is ready. | M233.44 |  |  |  |  |  | START |

**Position offset:** This value will only take effect when Enable Location

Limitation is not checked. Example: The value is 10mm, that is, the laser light exits from the edge 10mm.

**Close warning:**Close all alarms, that is, no alarm prompt appears at the top of the interface.

**Range:**This feature is temporarily unavailable.

### Simulated line speed setting

**Setting method:**Use the encoder unchecked, as shown in Figure 3-8. Measure the line speed first, then fill the line speed into the fixed speed. When the following conditions occur during marking, the fixed speed can be modified until normal.

Figure 1

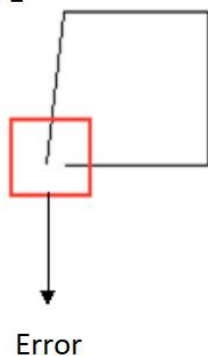


Figure 2

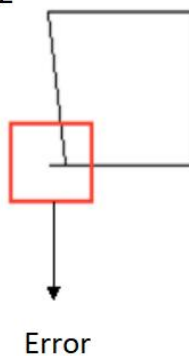
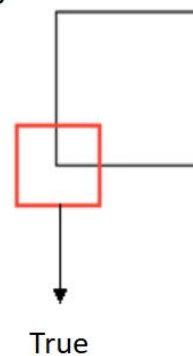


Figure 3



When the situation in Figure 1 or Figure 2 occurs, increase or decrease the simulation speed value according to the on-site laser placement direction and the pipeline direction until the marked figure is shown in Figure 3.

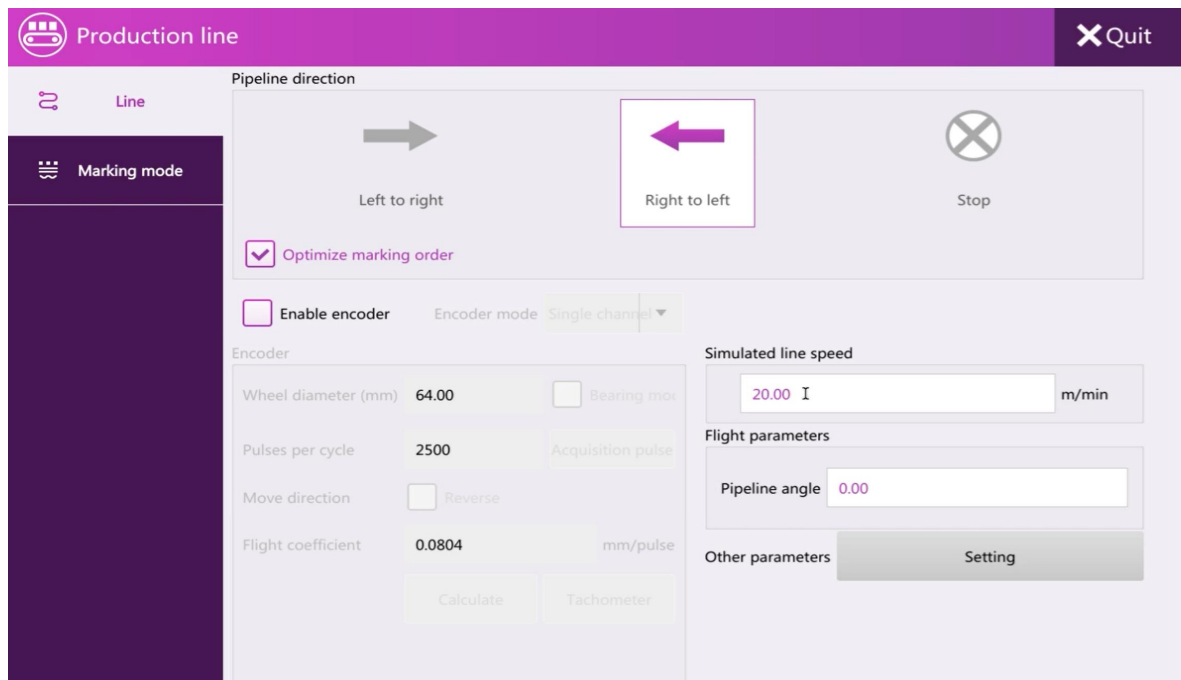


Figure 3-8

## Marking mode settings

Three marking modes: normal mode, pipeline mode, continuous marking mode

### 3.1.2.1. Normal mode

Select normal mode for the coding mode, and the sensor is turned on, as shown in Figure 3-9.

**Sensor distance:** Probe distance, that is, the distance between the probe installation position and the marking position.

**TSBOT:** Within the set distance, the system will automatically shield the trigger signal received by the sensor.

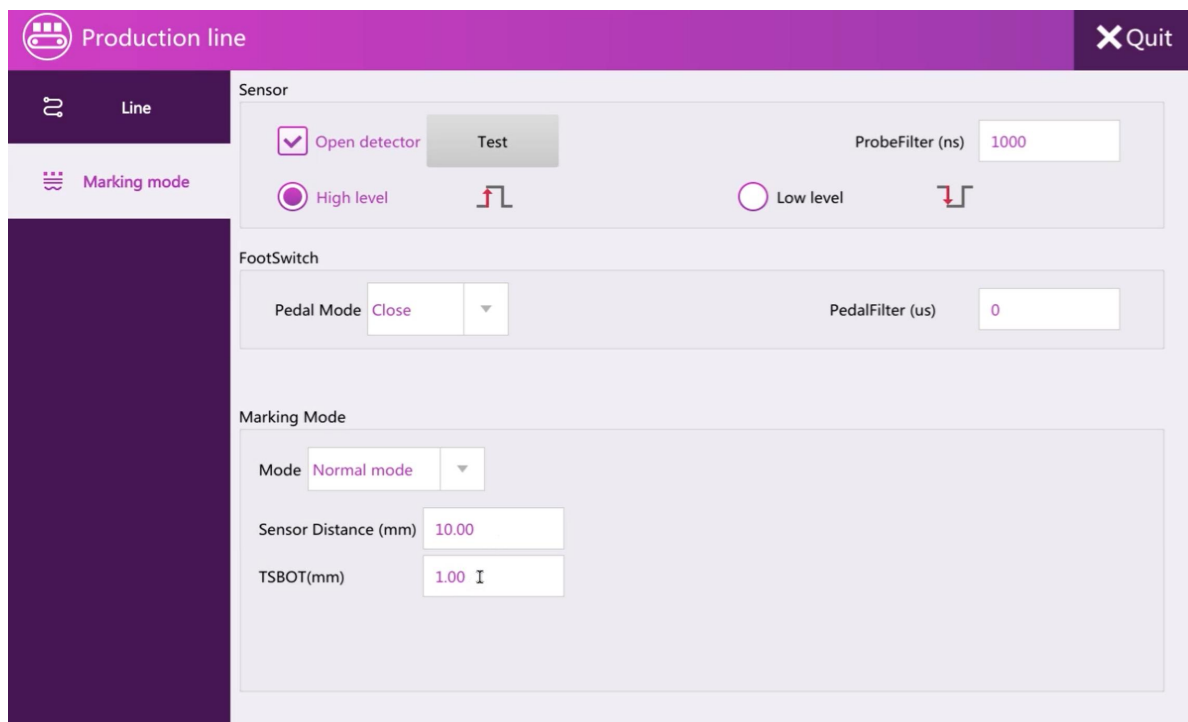


Figure 3-9

### 3.1.2.2. Pipeline mode

The marking mode selects the pipeline mode, as shown in Figure 3-10

**Starting distance:**From the moment you click to start marking, the code starts to be coded after this distance.

**Mark distance:**The distance between the last marking and the next marking.

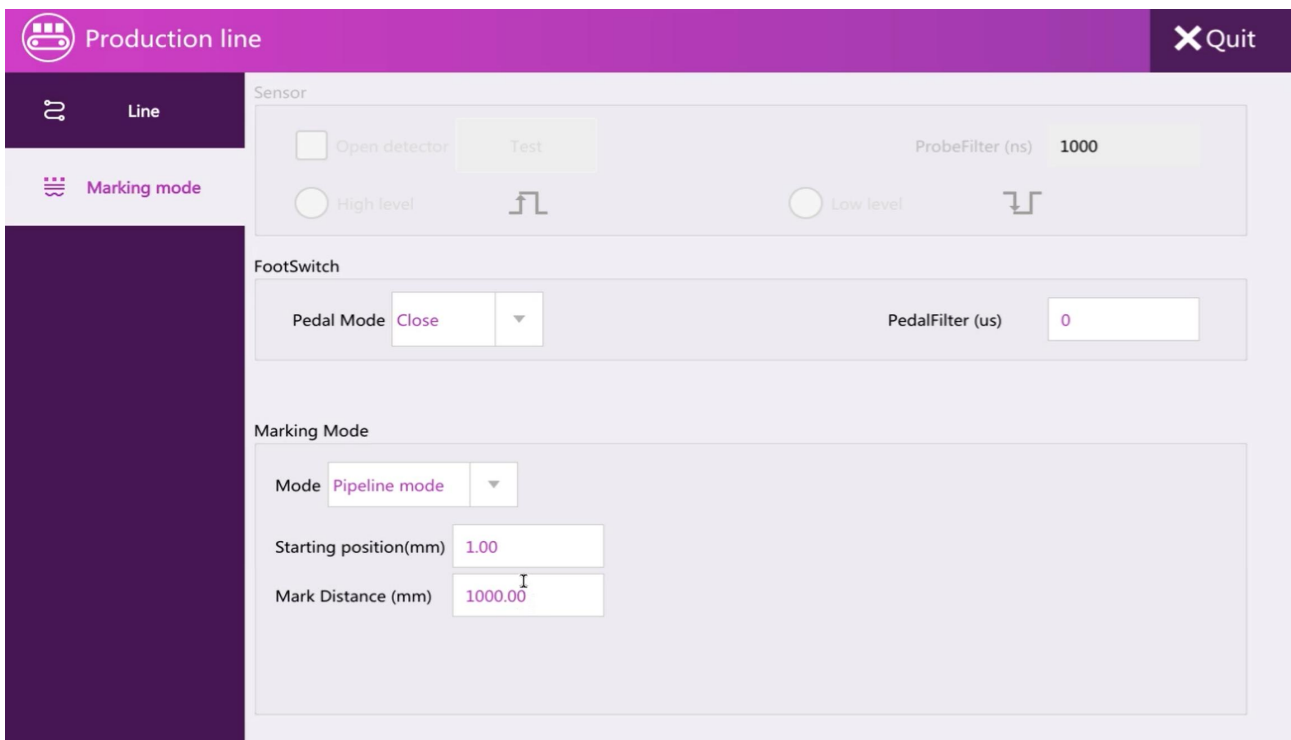


Figure 3-10

### 3.1.2.3. Continuous mode

Select continuous coding for the coding mode, as shown in Figure 3-11. At this time, the sensor must be turned on and the code will be printed only when the sensor is always at a high level.

**Sensor distance:**Probe distance, that is, the distance between the probe installation position and the marking position.

**Mark times:**Set the number of continuous coding, when there is no limit, when the sensor is at high level, the system will always code according to the set distance.

**TSBOT:**Within the set distance, the system will automatically shield the trigger signal received by the sensor.

**Mark space:**The distance between the last marking and the next

marking.

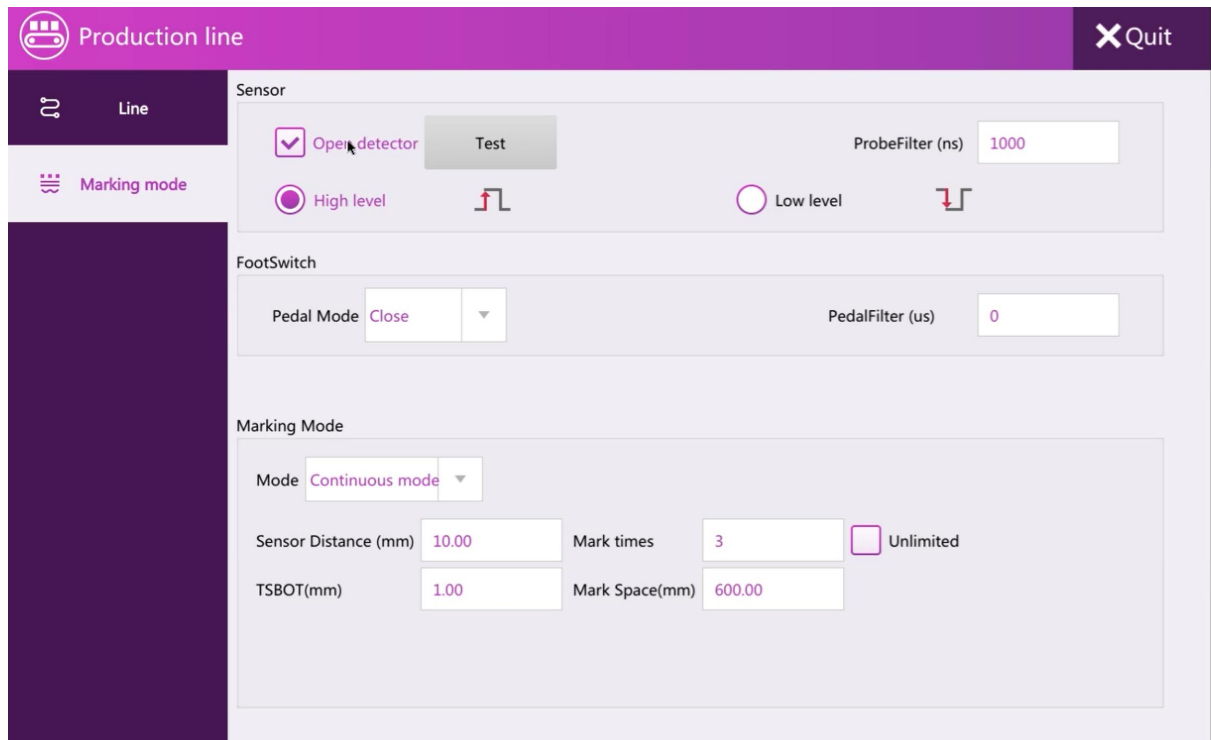


Figure 3-11

## 4. Setting

### 4.1. Marking parameters

Select the marking file on the homepage, click Settings-spraying parameters to change the parameters of the marking data, you can modify the default value.

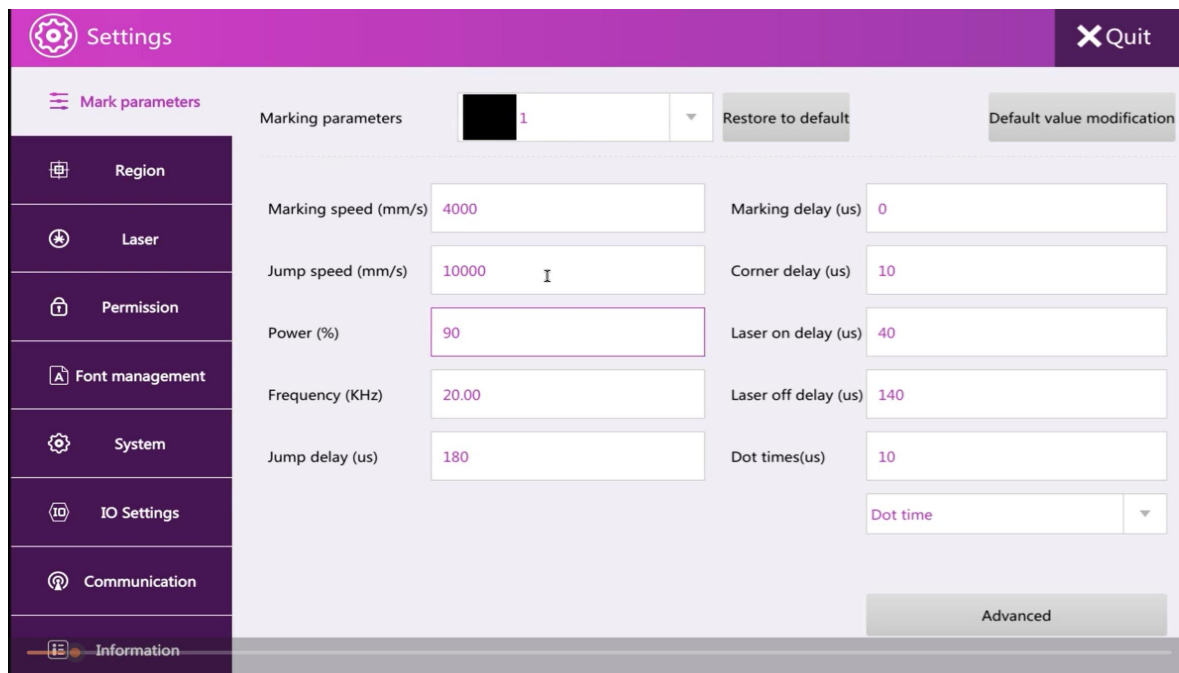


Figure 4- 1

### **Marking speed (mm/s)**

Marking speed describes the "writing" speed of the focus of the laser beam on the surface of the marking object

### **Jump speed(mm/s)**

Jump speed describes the speed at which a vector graphic is drawn after jumping to the next vector graphic. The typical value is twice the marking speed.

### **Power (%)**

The relative power of the laser (unit: %). The larger the value, the higher the power. It is recommended not to exceed 90% during use.

### **Frequency (KHz)**

The laser frequency describes the number of pulses per unit time, that is, the number of points per second (unit: KHz)

## **Pulse width (us)**

Laser pulse width

## **Delay parameter**

The delay parameters mainly include jump delay, light-on delay, laser-off delay, marking delay and corner delay. The delay must be adapted to the defined jump speed and marking speed. If the delay is not optimized, the quality of the marking result will decrease and the marking time will be extended.

In general, the length of the open laser delay and the off laser delay have no effect on the total scan time. The on-laser delay and off-laser delay should be optimized first, followed by the delay of the mark control, ie the jump delay, the end-of-mark delay and the turning point delay. It is very useful to set the jump delay and the end of the marking delay to a large value during the optimized laser delay.

Below we will illustrate the effect of various marking delays on marking quality by way of example:

### **Jump delay is too short**

If the jump delay is too short, after the jump, the scan head is not positioned yet. The first marking vector has started and will show an in-motion oscillation effect, as shown in Figure 4-2.

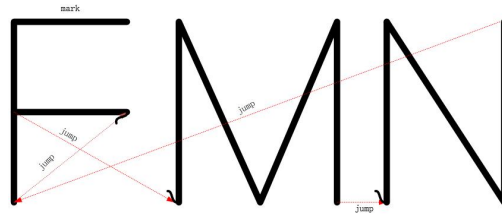


Figure 4- 2

### **Jump delay is too long**

If the hop delay is too long, there is no significant impact. However, the marking time will be extended.

### **Laser-on delay is too short**

If the Laser-on delay is too short, the laser is turned on at the beginning of the marking vector. Even if the galvanometer has not reached the required angular velocity, the starting point of each vector has a coking phenomenon, as shown in Figure 4-3.

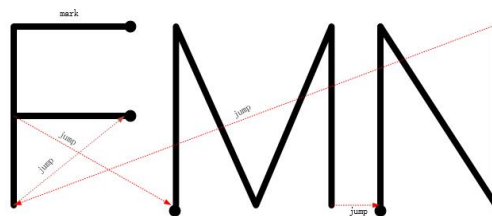


Figure 4- 3

### **Laser-on delay is too long**

If the laser-on delay is too long, the laser turns on too late at the beginning of the marking vector. The starting point of the vector is not marked, as shown in Figure 4-4.

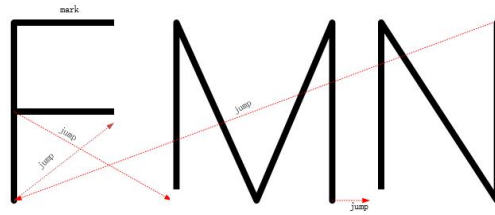


Figure 4- 4

### Laser-off delay is too short

If the laser-off delay is too short, although the galvanometer has not yet reached the final position of the vector, the laser is turned off after the last marking command of a straight line or polyline, resulting in the respective vectors not being fully marked. As shown in Figure 4-5.

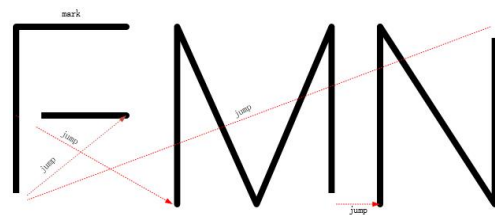


Figure 4- 5

### Laser-ff delay is too long

If the laser-off delay is too long, the laser is turned off too late after the last marking command of the line or polyline, the laser is still on, even if the galvanometer has stopped or moved very slowly, the result is that the end of each vector is coking phenomenon, As shown in Figure 4-6.

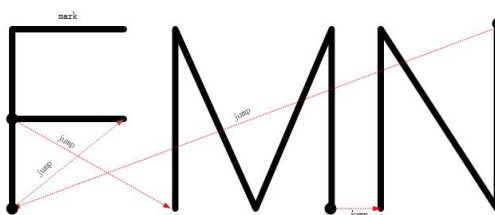


Figure 4-6

### Marking delay

No significant change, but the larger the value, the longer the marking time.

### Corner delay is too short

If the corner delay is too short, the marking command on the subsequent polyline is already being executed, but the galvanometer has not reached the end point of the previous marking vector, which will cause the corner to appear arc-shaped. As shown in Figure 4-7.

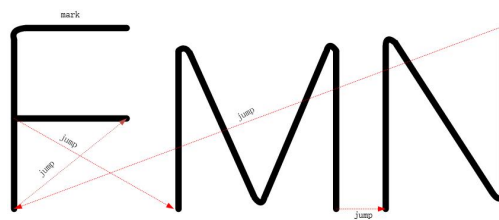


Figure 4-7

### Corner delay is too long

If the corner delay is too long, the galvanometer moves too slowly at this time or even stops when the subsequent marking command is executed. Since the laser is not turned off between these vectors, coking will occur, as shown in Figure 4-8.

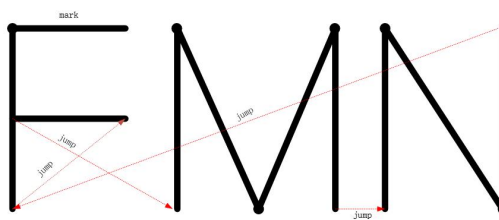


Figure 4-8

### Dot times(us)

Single-point energy, this function is effective when the font is dot matrix font or dot and dot matrix QR code is added, when  $\sqrt{\quad}$ , it is dot time output, when it is not  $\sqrt{\quad}$ , it is dot pulse output.

**Jump limit, length limit, length control:**Being not

## 4.2. Region

The region includes galvanometer calibration and red light guidance calibration, as shown in Figure 4-9.

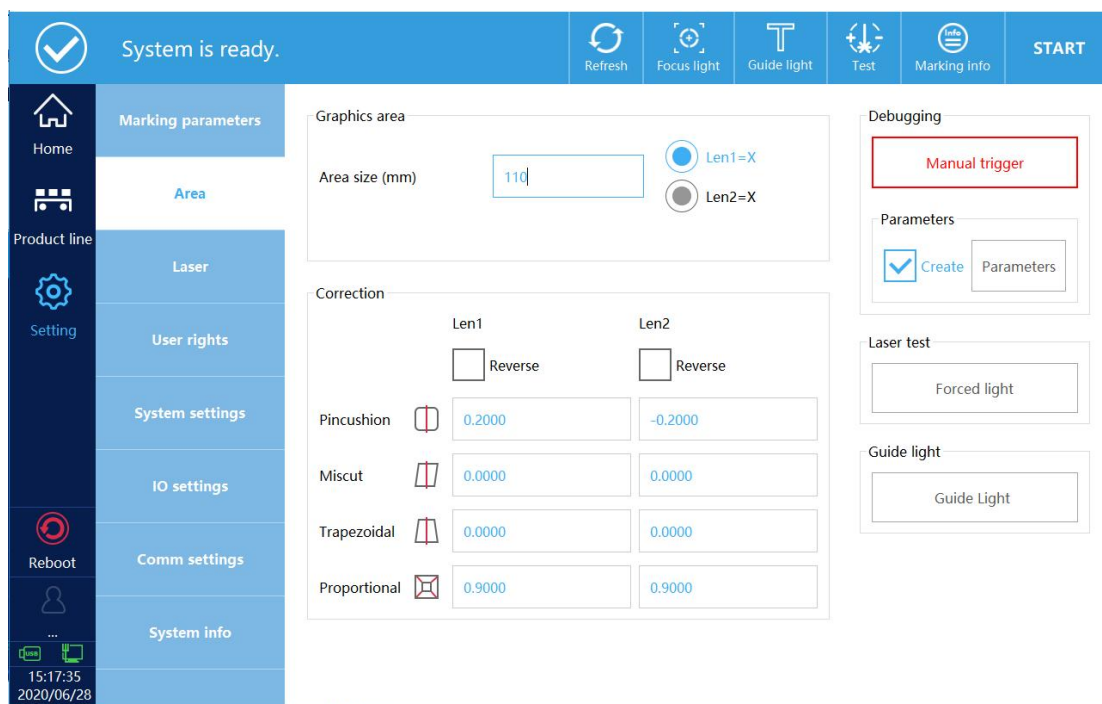


Figure 4-9

### 4.2.1. Galvanometer calibration

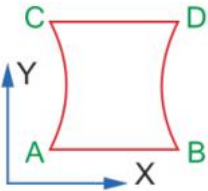
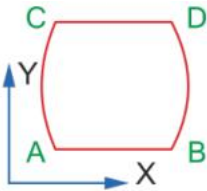
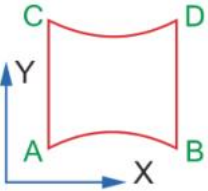
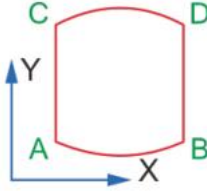
**Area size:**Marking range of current field lens.

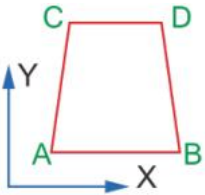
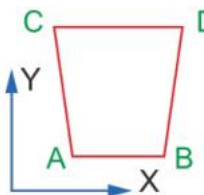
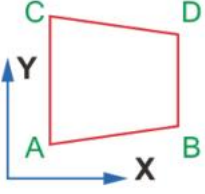
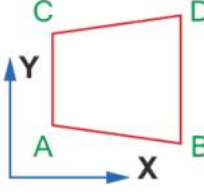
**Len 1=X, Len 2=X:**Select Len 1=X and click manual trigger. When the marked ABC is horizontal, it is correct. When the marked ABC is vertical, it means that the selection is wrong, then choose Len 2=X.

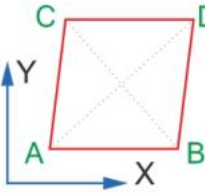
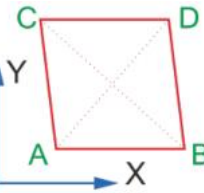
**Correction:**Observe whether the marked ABC is reversed according to the on-site situation, rotate it, and select the corresponding galvanometer to reverse until the marked content is what you need.

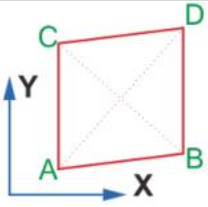
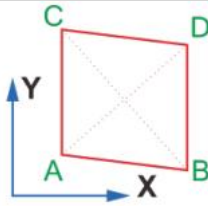
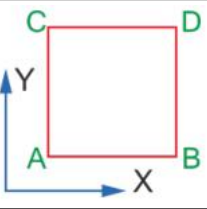
**The coefficient correction method is shown in the following table**

First, select the automatic creation of debugging parameters, and then click the test parameters to set the size of the rectangle. Example: If the area size is 110, the rectangle size is set to 109, and then click to trigger manually.

| <b>Pincushion</b>   |  |
|---|--|
|  |  |
| <p>Reduce X or Y axis corresponding galvanometer coefficient</p>                    | <p>Increase the X or Y axis corresponding to the galvanometer coefficient</p>        |
|  |  |
| <p>Reduce X or Y axis corresponding galvanometer coefficient</p>                    | <p>Increase the X or Y axis corresponding to the galvanometer coefficient</p>        |

| <b>Trapezoidal</b>  |  |
|---|--|
|  |  |
| <p>Reduce X or Y axis corresponding galvanometer coefficient</p>                  | <p>Increase the X or Y axis corresponding to the galvanometer coefficient</p>      |
|  |  |
| <p>Reduce X or Y axis corresponding galvanometer coefficient</p>                  | <p>Increase the X or Y axis corresponding to the galvanometer coefficient</p>      |

| <b>Miscut</b>   |  |
|---|--|
|  |  |
| <p>Reduce X or Y axis corresponding</p>   | <p>Increase the X or Y axis</p>  |

|   |  |
|---|--|
| galvanometer coefficient  | corresponding to the galvanometer coefficient                                      |
|    |  |
| Reduce X or Y axis corresponding galvanometer coefficient   | Increase the X or Y axis corresponding to the galvanometer coefficient             |
| <b>Proportional</b>   |  |
|   |  |
| <p>Measure the length of the frame that is actually marked, and then fill in the coefficient obtained by dividing the set length by the length of the actual mark (Note: the coefficient cannot be greater than 1, such as setting the range of 109, the mark is only 100, indicating that the maximum area range can only be marked with 100, and then the area range can be changed to 100)</p> |  |

#### 4.2.2. Red light guide calibration

Click the red light guide setting to enter the red light guide calibration interface, as shown in Figure 4-10.

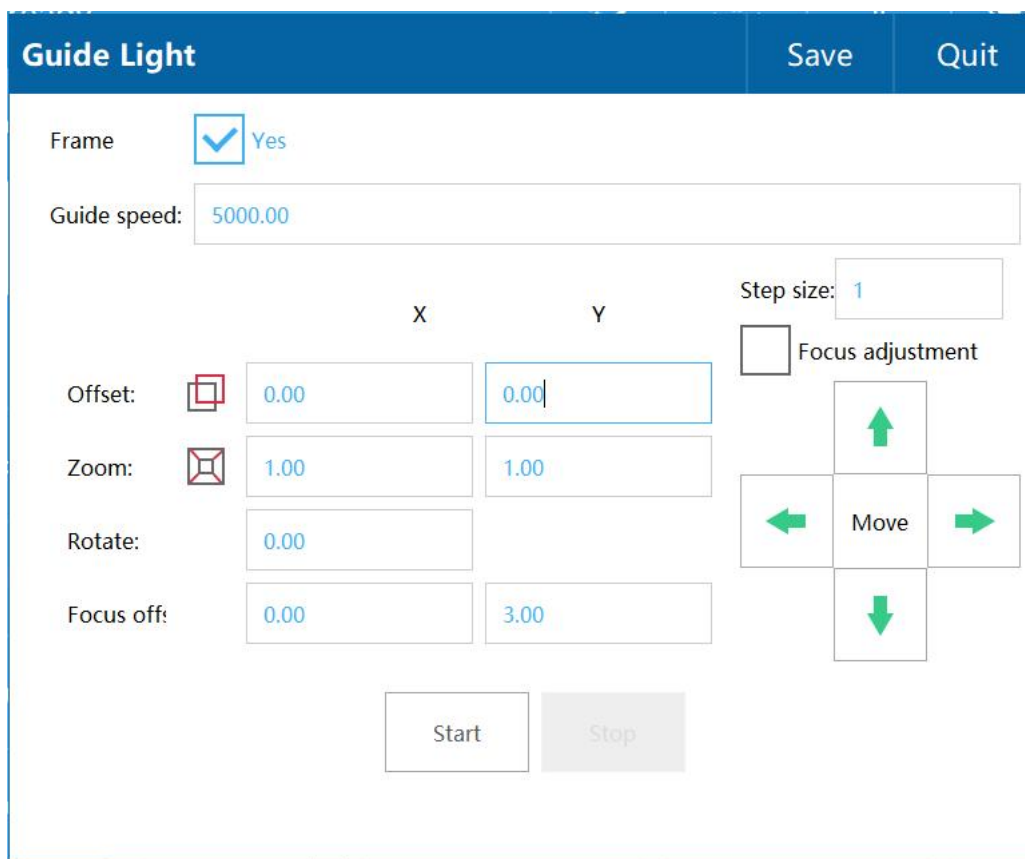


Figure 4- 10

**Frame:**When "Yes" is selected, it is guided by a rectangle; when it is not selected, it is guided by the full path of the glyph.

**Guide speed:**Guide red light line drawing speed.

**The red light guide calibration method is as follows:**

- 1、 Add a rectangular marking.
- 2、 Click the red light guide, adjust the offset, zoom, etc. so that the red light guide light completely coincides with the marked figure.

**The red light focusing method is as follows:**

- 1、 Red light focusing must have two red lights, one for fixed red light and one for adjustable red light.
- 2、 Check the red light focus adjustment, adjust the four buttons up,

down, left and right to make the two red lights completely coincide.

### 4.3. Laser

Select the laser type and modify the laser parameters, the interface is shown in Figure 4-11.

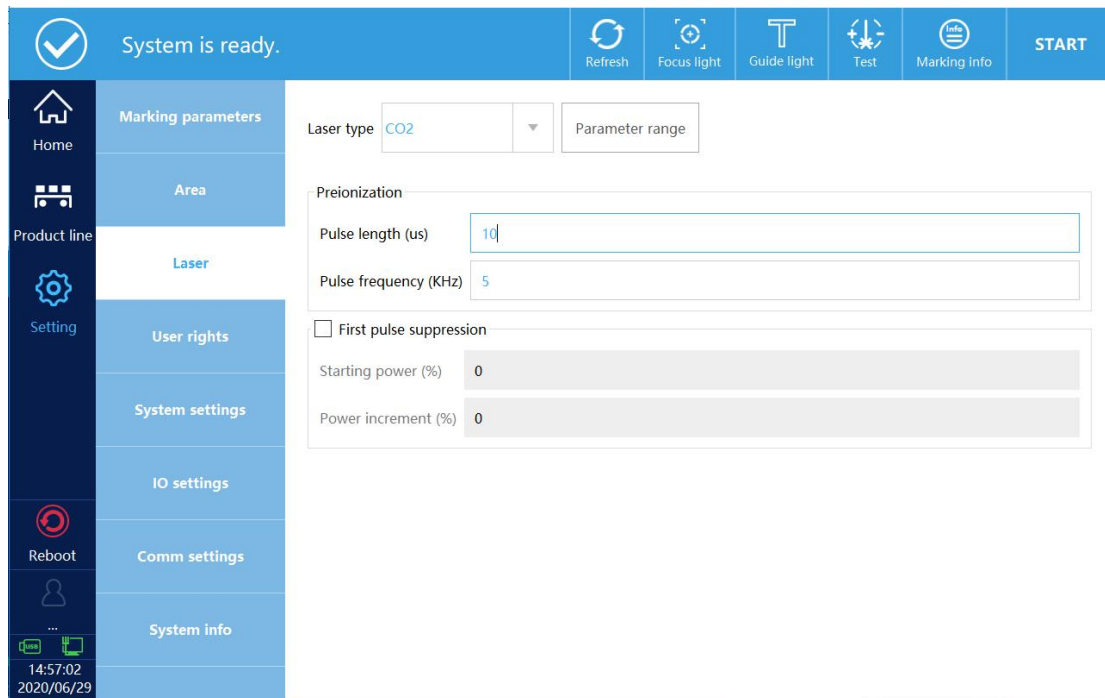


Figure 4- 11

**Laser type:**Select the type of laser, if the laser is CO2, it should be correspondingly selected as CO2, restart the system.

**Parameter range:**Modify the range of laser power and frequency.

**Fiber laser properties:**The interface is shown in Figure 4-12

**MO signal:**Can choose normally open or not normally open, usually MO needs to be opened.

**MOPA:** If the laser is a MOPA structure laser, MOPA needs to be turned on.

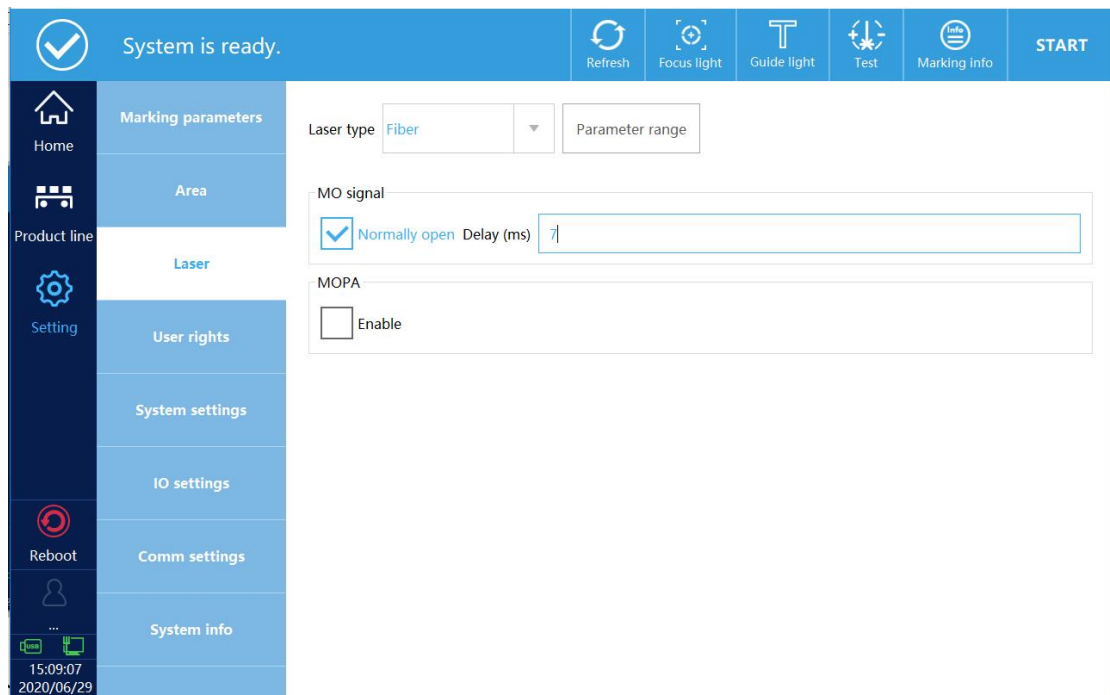


Figure 4- 12

**CO2 laser properties:**The interface is shown in Figure 4-13

**Pre-ionization:**Generally do not need to be modified, if the laser is found to have weak light leakage, reduce the pulse frequency.

**First pulse suppression:**If the starting point is too deep, you need to turn on the first pulse suppression and set the starting power.

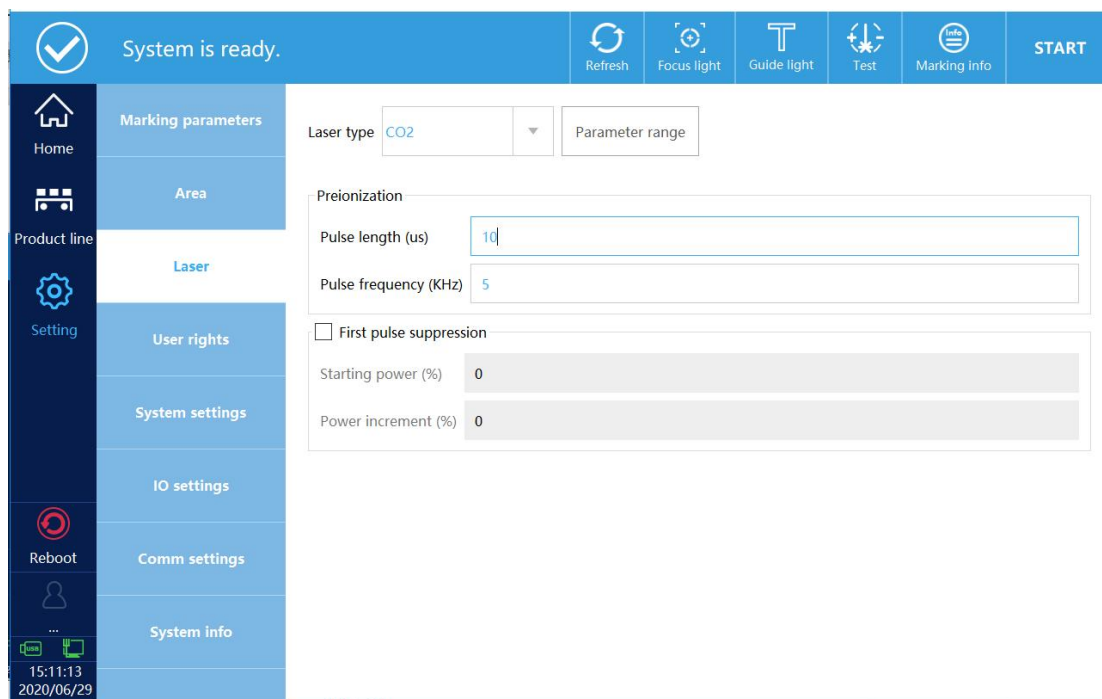


Figure 4- 13

### UV laser properties

The minimum and maximum frequency of PWM can be set. For some brands of UV lasers, when the light output reverses, that is, 1% power output power is maximum and 100% output power is minimum. In this case, select "Yes" for the PWM signal reverse, such as light output If the phenomenon is normal, you do not need to choose, as shown in Figure 4-14.

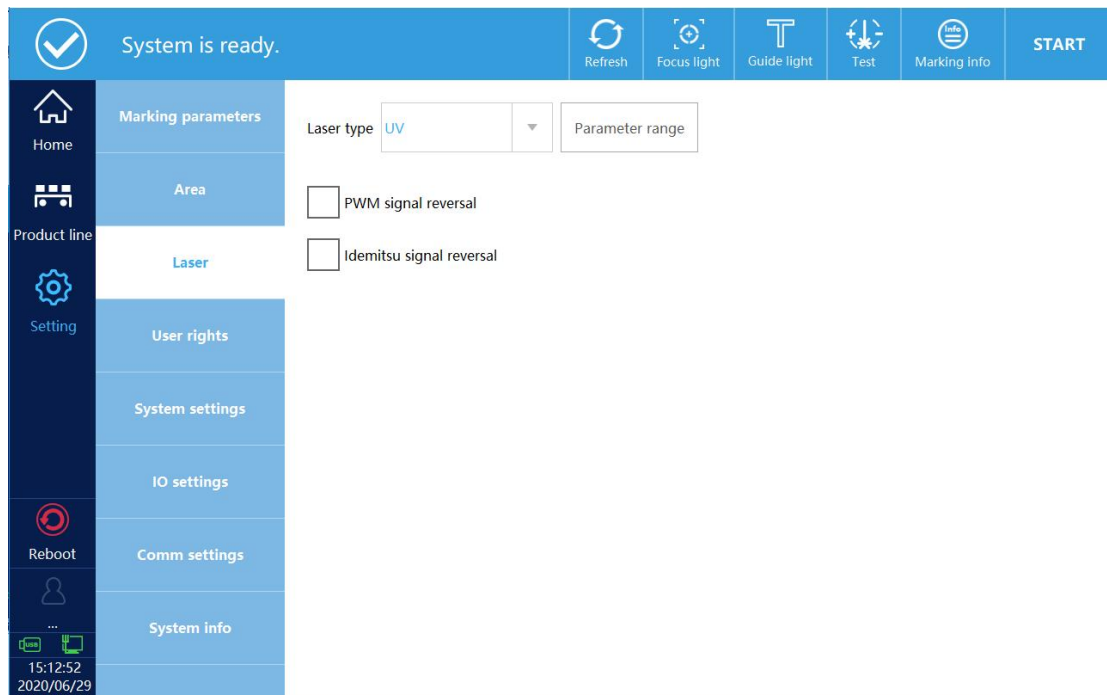


Figure 4- 14

**Inno/lightwave laser properties:**The interface is shown in Figure 4-15.

All configurations on this page can be selected by default, because the UV laser needs to be preheated. After a few minutes after booting, the laser will automatically start.

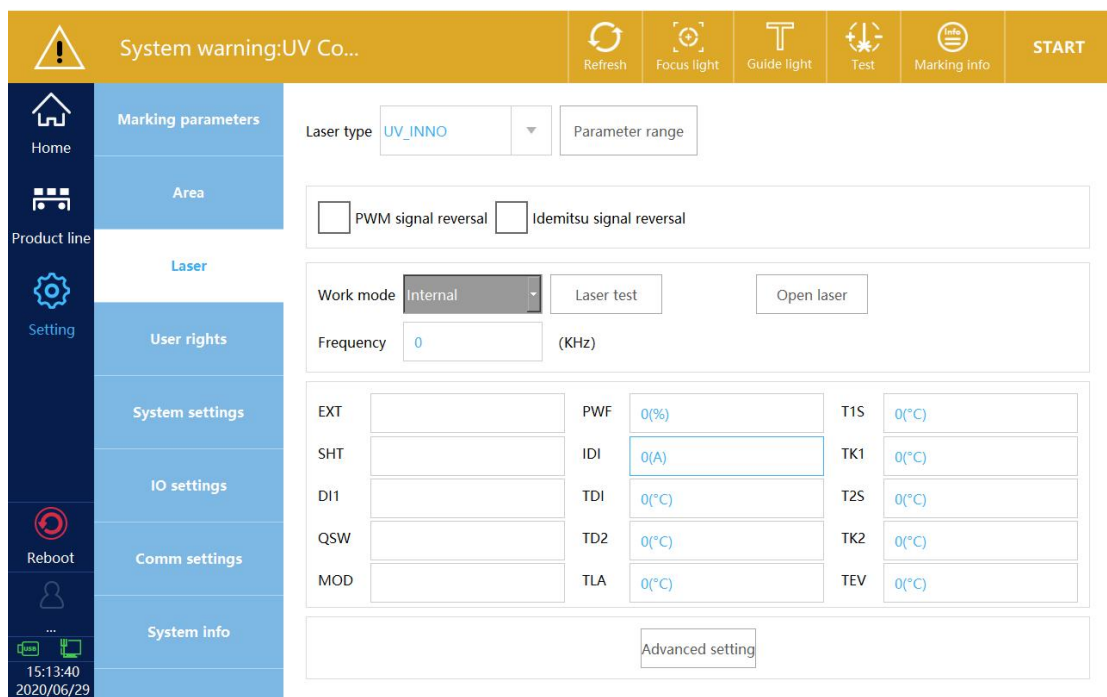


Figure 4- 15

## 4.4. User rights

Set user permissions and passwords hierarchically, as shown in Figure 4-16. Log in to the administrator user (password: 123), and set the permissions and password for each user. Example: Change the password of Level1 user to 888, as shown in tu, set the user's use rights, and cancel the three functions of adding objects, editing objects, and file operations using Figure 4-17, as shown in Figure 4-18. Log out of the administrator user and log in to the Level1 user. The user's shielding function has become gray and cannot be used, as shown in Figure 4-19.

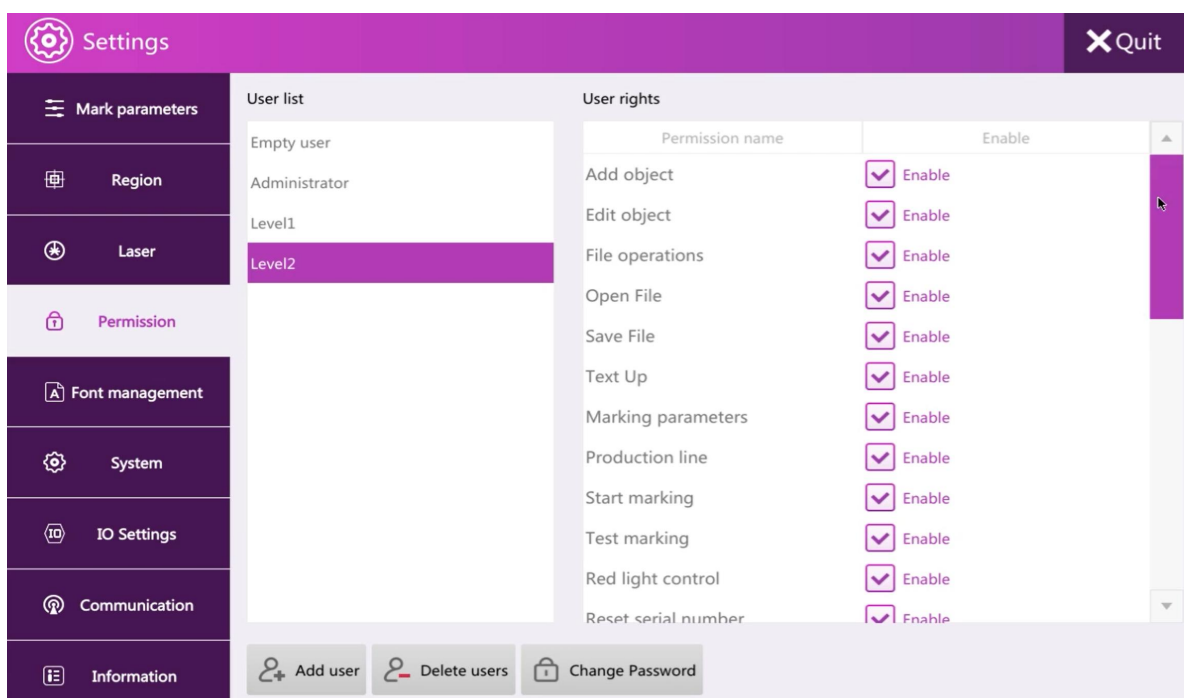


Figure 4- 16

### Change Password

Username: Admin

Password:

Confirm password:

Figure 4- 17

System is ready. Refresh Focus light Guide light Test Marking info START

Home Product line Setting Reboot Administrator 15:21:12 2020/06/29

Marking parameters Area Laser User rights System settings IO settings Comm settings System info

#### User list

|               |
|---------------|
| Empty user    |
| Administrator |
| Level1        |
| Level2        |
| ttt           |

#### User rights

| Permission name     | Enable                                     |
|---------------------|--|
| Add object          | <input type="checkbox"/> Enable            |
| Edit object         | <input type="checkbox"/> Enable            |
| File operations     | <input type="checkbox"/> Enable            |
| Marking parameters  | <input checked="" type="checkbox"/> Enable |
| Production line     | <input checked="" type="checkbox"/> Enable |
| Start marking       | <input checked="" type="checkbox"/> Enable |
| Test marking        | <input checked="" type="checkbox"/> Enable |
| Red light control   | <input checked="" type="checkbox"/> Enable |
| Reset serial number | <input checked="" type="checkbox"/> Enable |
| Clear count         | <input checked="" type="checkbox"/> Enable |
| Clear alarm         | <input checked="" type="checkbox"/> Enable |

Figure 4- 18

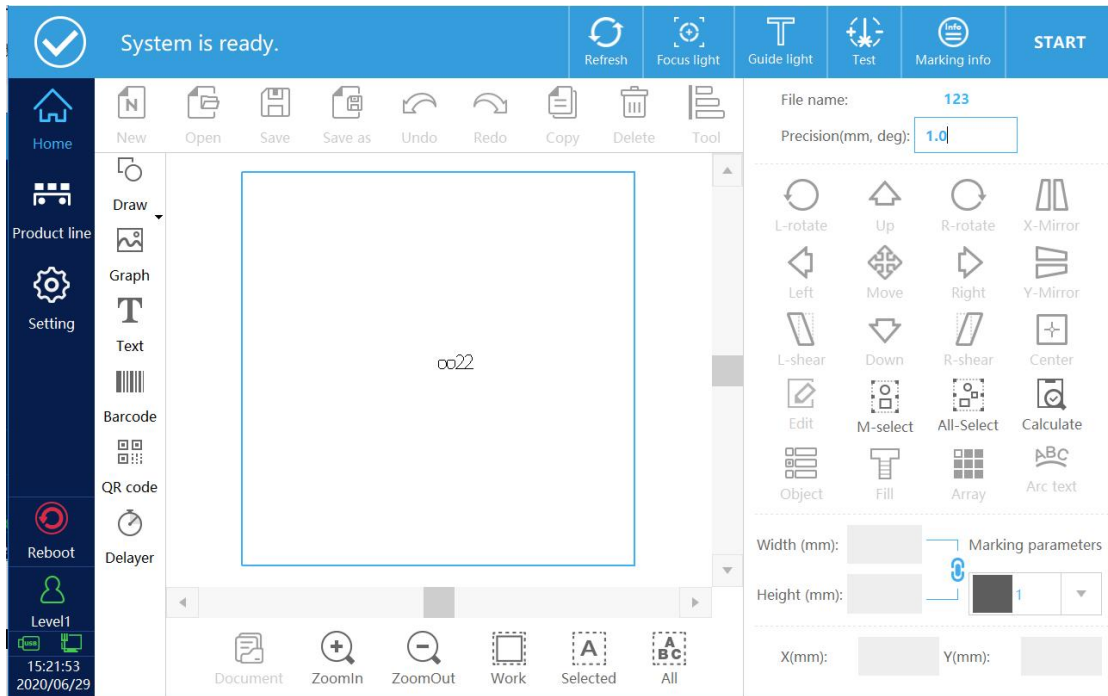


Figure 4- 19

## 4.5. System settings

As shown in Figure 4-20.

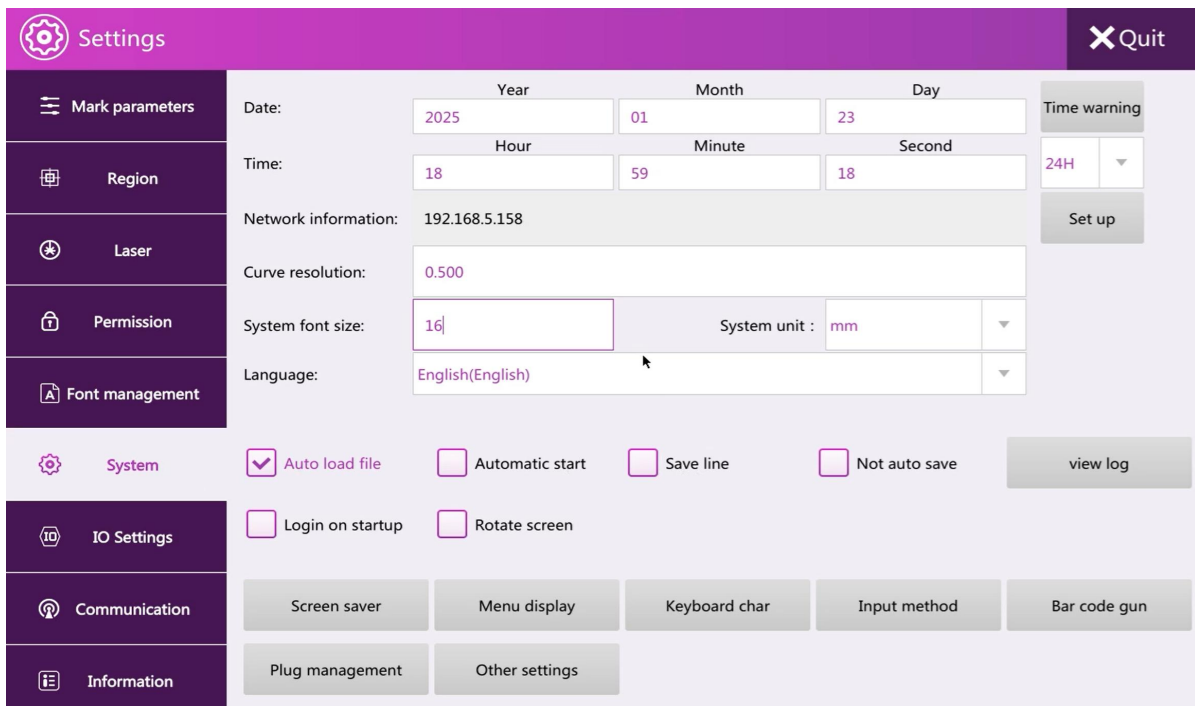


Figure 4- 20

### System settings:

**Date:**Set system date.

**Time:**Set system time.

**Internet Information:**Set the DHCP information of the motherboard, click Settings, and the interface pops up, as shown in Figure 4-21. Click Enable to set the network information, and then click Save.

| Network settings |                                 | Save | Quit |
|------------------|---------------------------------|------|------|
| Net              | Net0-Local                      |      |      |
| DHCP             | <input type="checkbox"/> Enable |      |      |
| Host name:       | SmarkX                          |      |      |
| IP address:      | 192.168.5.158                   |      |      |
| Subnet mask:     | 255.255.255.0                   |      |      |
| Gateway:         | 192.168.5.254                   |      |      |
| DNS:             | 192.168.5.254                   |      |      |

Figure 4- 21

**Host name:**Set the motherboard name.

**IP address:**Set the motherboard IP address.

No need to set subnet code, gateway, DNS

**Language:**Set the system language type, support more than 16 languages, you need to restart the system after switching languages.

**BC settings:**Developer options.

## Screensaver settings

Enable the screen saver function, you can set the screen saver time, screen saver content, backlight, etc., as shown in Figure 4-22.

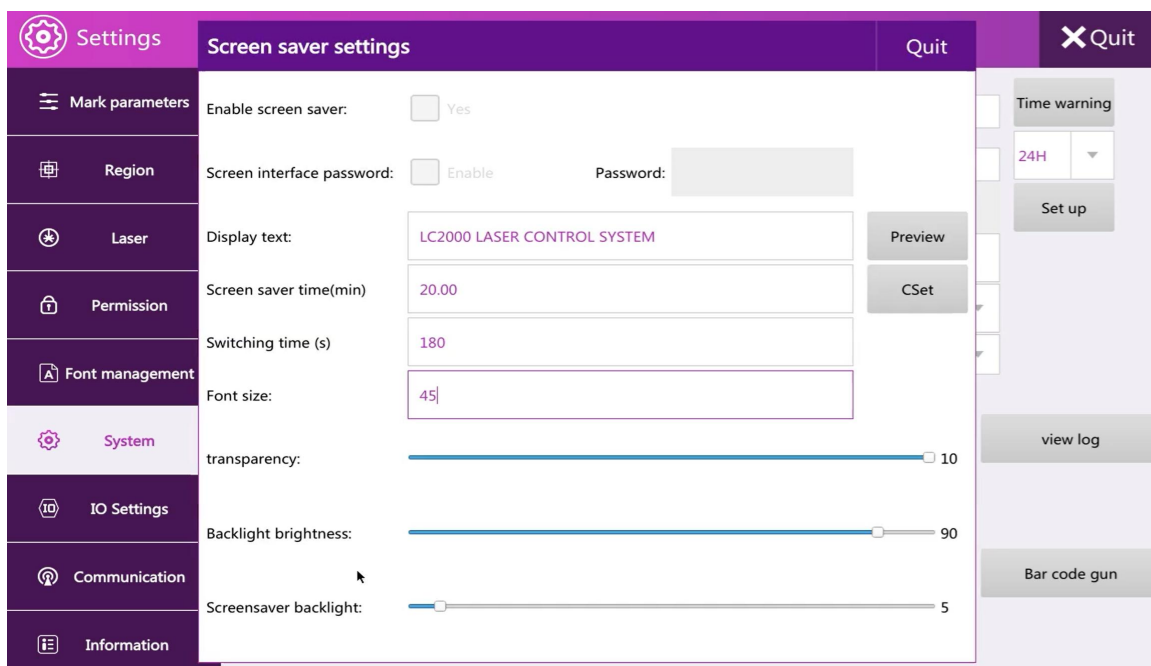


Figure 4- 22

## Other settings

**Automatically load files:**Automatically load files opened before shutdown after booting.

**The menu displays:**Whether the check function is displayed in the status bar, for example: red light focus is not checked, as shown in Figure 4-23.

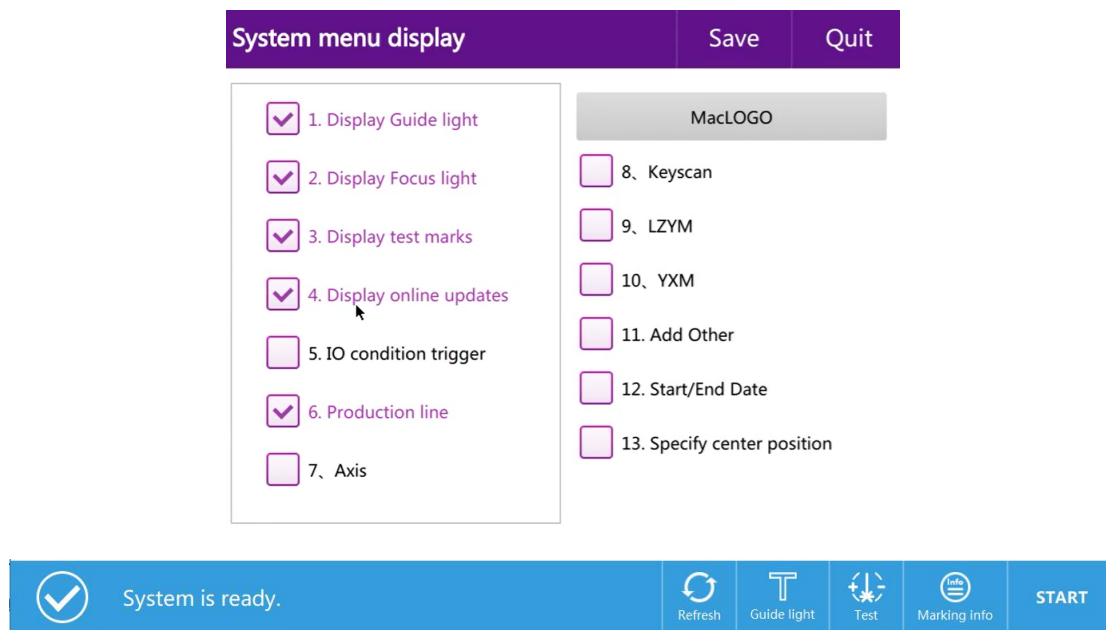


Figure 4- 23

**Keyboard characters:**To add symbols that are not in the existing keyboard, click Settings to enter the keyboard character management interface, as shown in Figure 4-24, click Add Character, Jinfu Unicode encoding interface, each character has its specific Unicode encoding, available online Find or find in Word. Example: Add the symbol ®, the corresponding Unicode code is 00AE, click 00AE on the interface, as shown in Figure 4-25, click Add, the symbol will be added to the keyboard character management interface, as shown in Figure 4-26, After the addition is complete, you can see the changed characters on the keyboard of the edited content, click the More button on the keyboard, as shown in Figure 4-27.

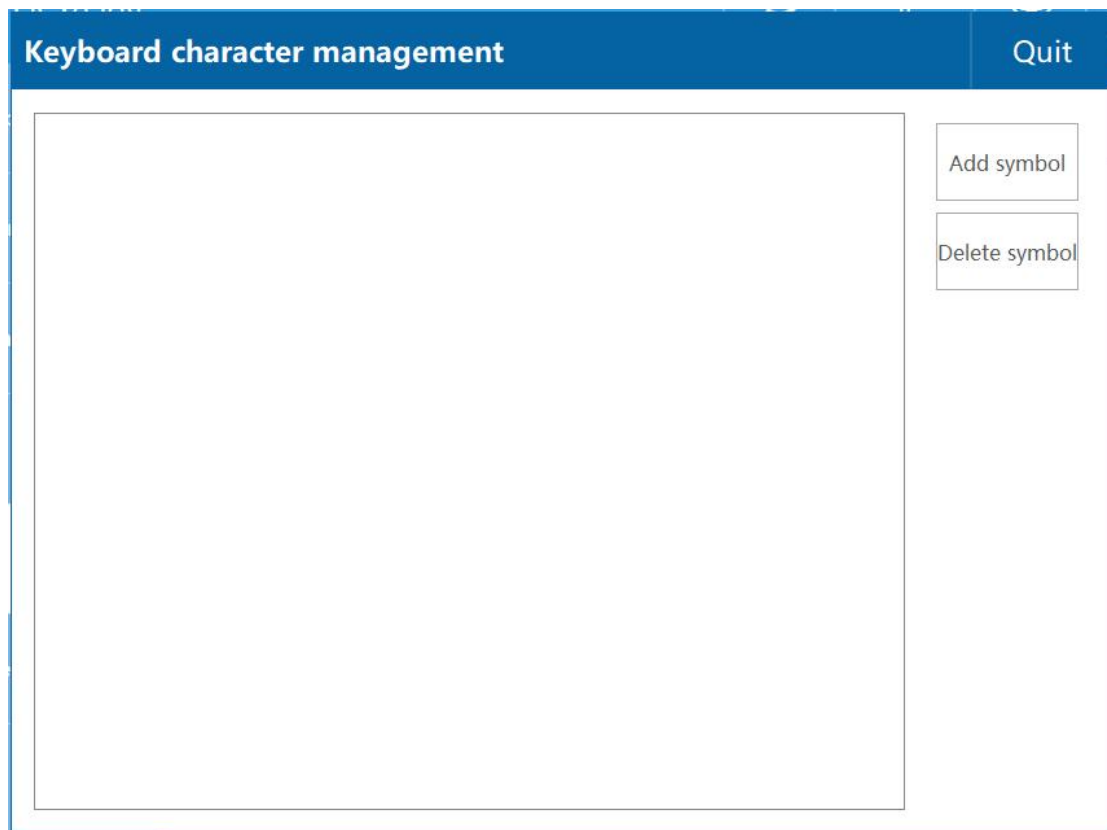


Figure 4- 24

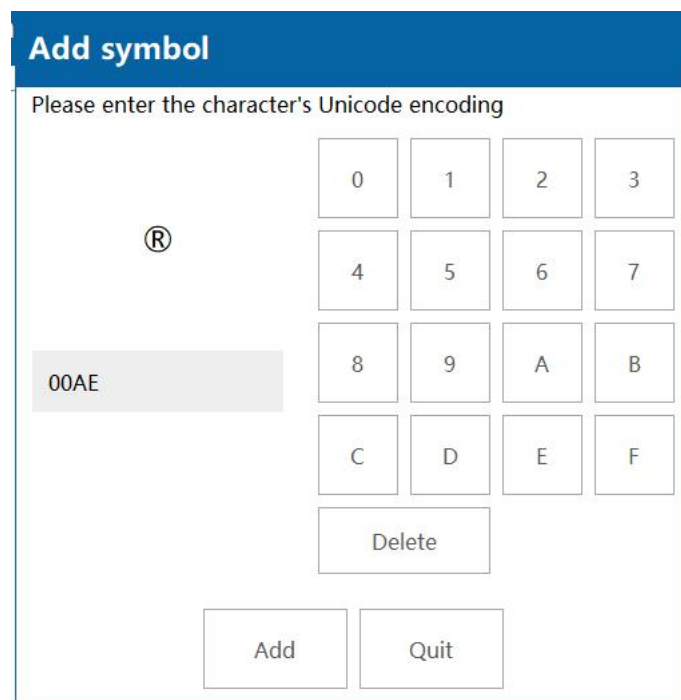


Figure 4- 25

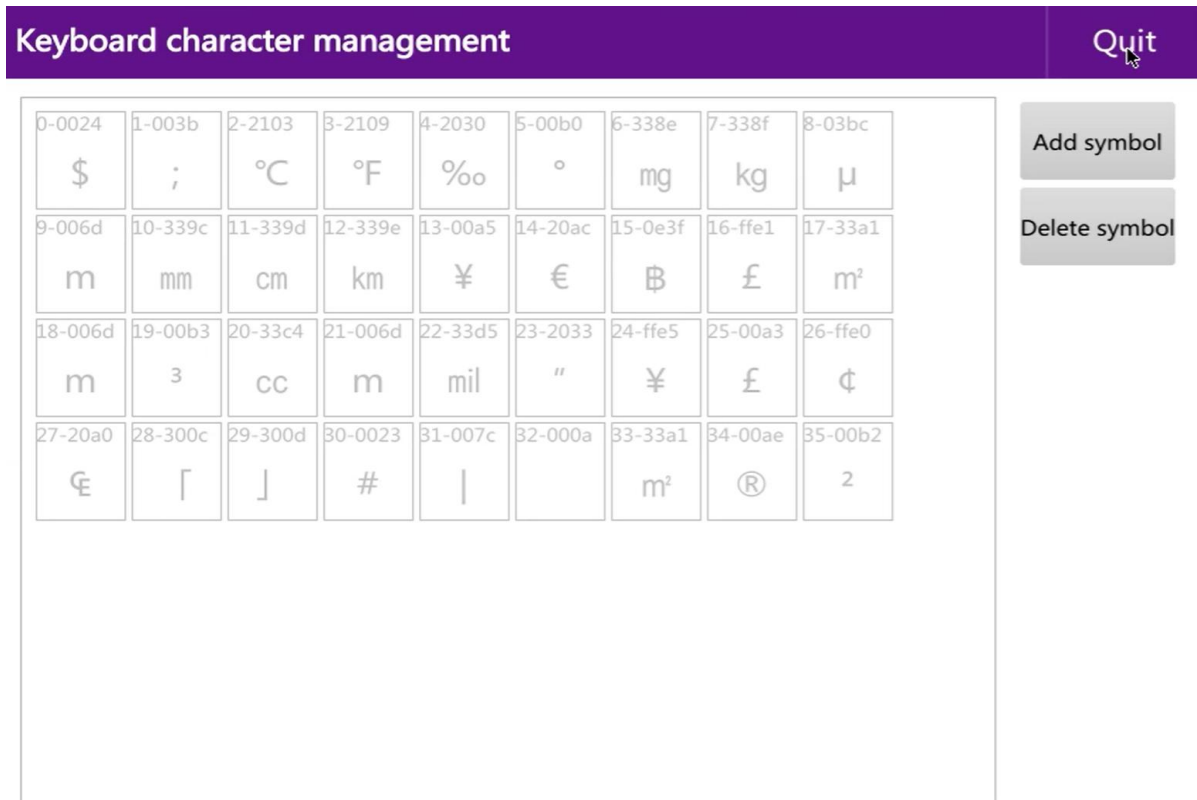


图 4-26

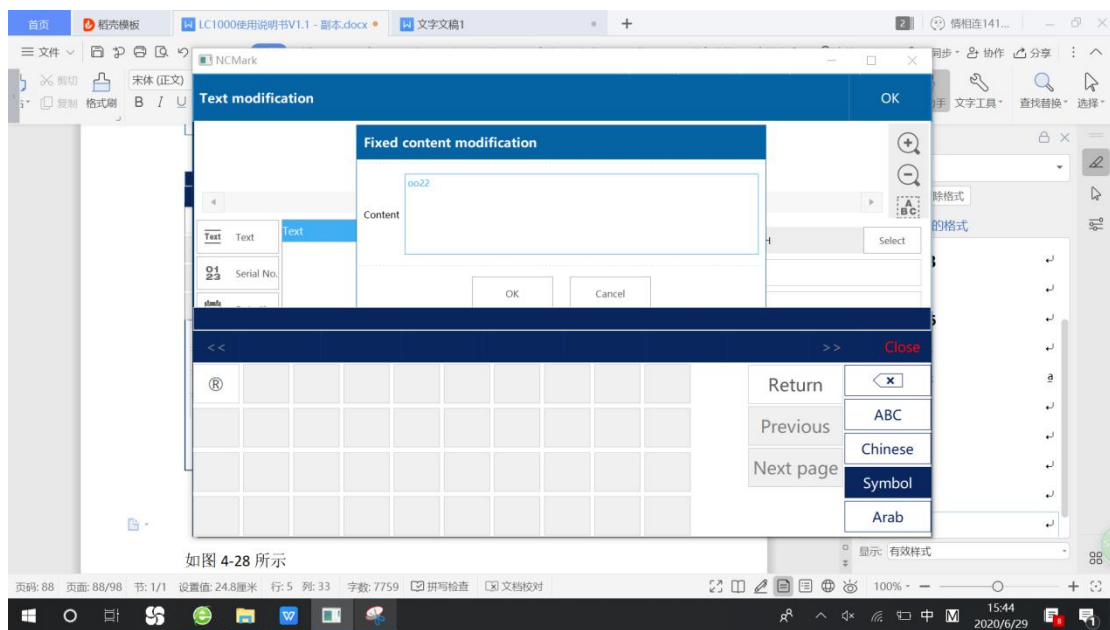


Figure 4- 27

**Input method settings:** Set the input method in the keyboard. The keyboard supports up to 4 input methods at the same time, as shown in Figure 4-28.

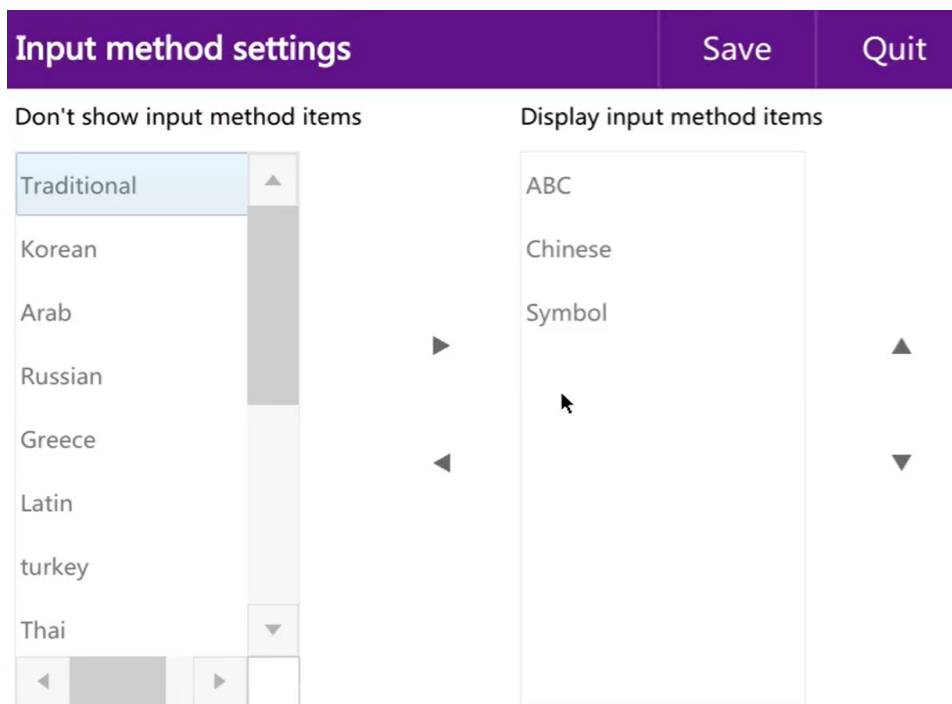


Figure 4- 28

## 4.6. IO settings

**Detection settings:**(For developers)

**IO output settings:**As shown in Figure 4-29, there are three IO signal outputs. Can be set: marking ready output, marking output, fault output, meter output, serial number end output.

Example: When the marking is required to end the output, the setting method is as follows:

- 1、 OUT-1 is set to mark the end of output.
- 2、 (Note: IO output is low level), if the wiring object is a solid state relay, the positive pole of the relay is connected to the 5V (PL19) output port of the interface board, and the negative pole is connected to the O\_1 port.
- 3、 Set the output signal width at the end of marking.

4、 Click Save and restart the system.

(Specific wiring and use method: please contact after-sales staff)

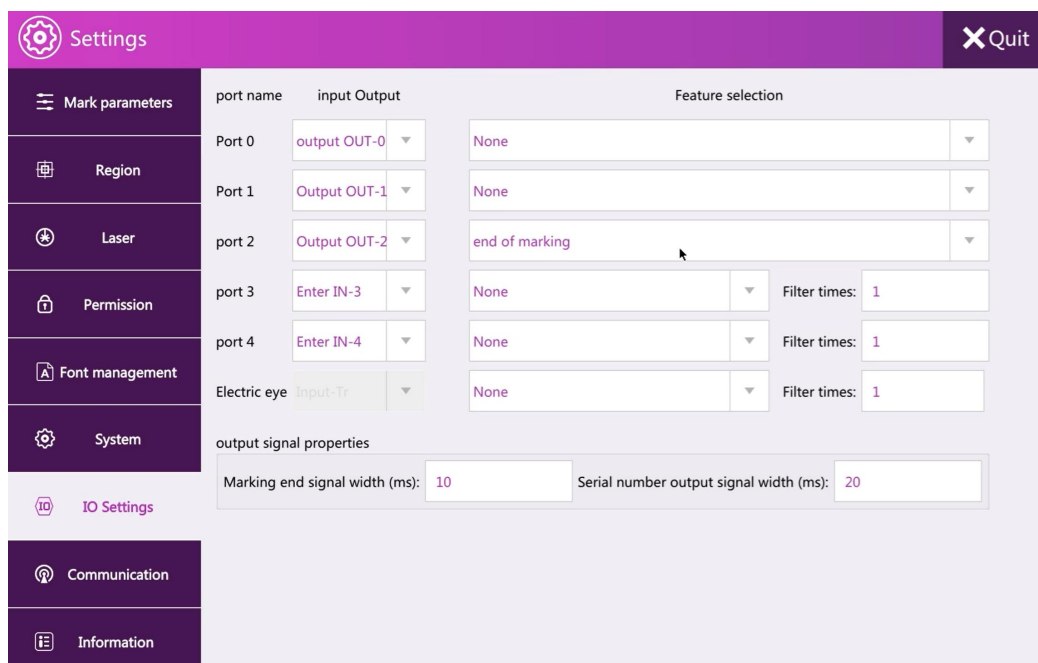


Figure 4- 29

Example: When the meter output is required, the operation steps are as follows:

- 1、 OUT-1 is set to meter output.
- 2、 (Note: IO output is low level), if the wiring object is a solid state relay, the positive pole of the relay is connected to the 5V (PL19) output port of the interface board, and the negative pole is connected to the O\_1 port.
- 3、 Marking mode is set to flying marking, trigger setting select pipeline mode.
- 4、 Click the coding information button at the top right of the screen, as shown in the meter counting information in Figure 4-30, enter the meter

counting function setting interface, as shown in Figure 4-31.

5、 Set metering parameters:

**Length:**Set the metering length. The metering starts when the pipeline is turned on, and a signal is output every time this value is reached (high level or low level, settable)

**Output:**Set the output signal to high or low.

**Signal time:**Set signal output time, unit ms.

**Output delay:**Set whether to delay the signal output, unit mm.

**Cumulative length:**The meter starts counting when the pipeline is turned on, and outputs a signal (high level or low level) whenever the accumulated length reaches the set length value.

**Signal status:**Current signal status

6、 Restart the system.

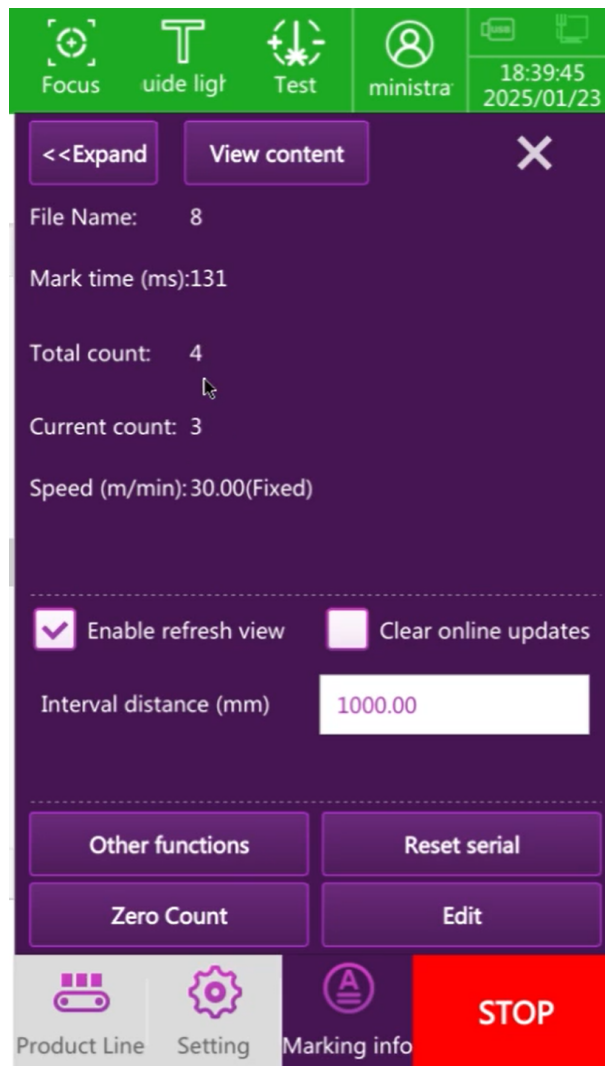


Figure 4- 30

**Meter Information** OK Quit

Enable meter:  Yes

Length (m): 0.00

Output: High level

Signal time (ms): 10

Output delay (mm): 0.00

Cumulative length (m): 0

Signal status:  Low

Figure 4- 31

## 4.7. Communication settings

If you need to use this function, please contact our staff.

## 4.8. System info

Display system related information and software update and registration, as shown in Figure 4-32.

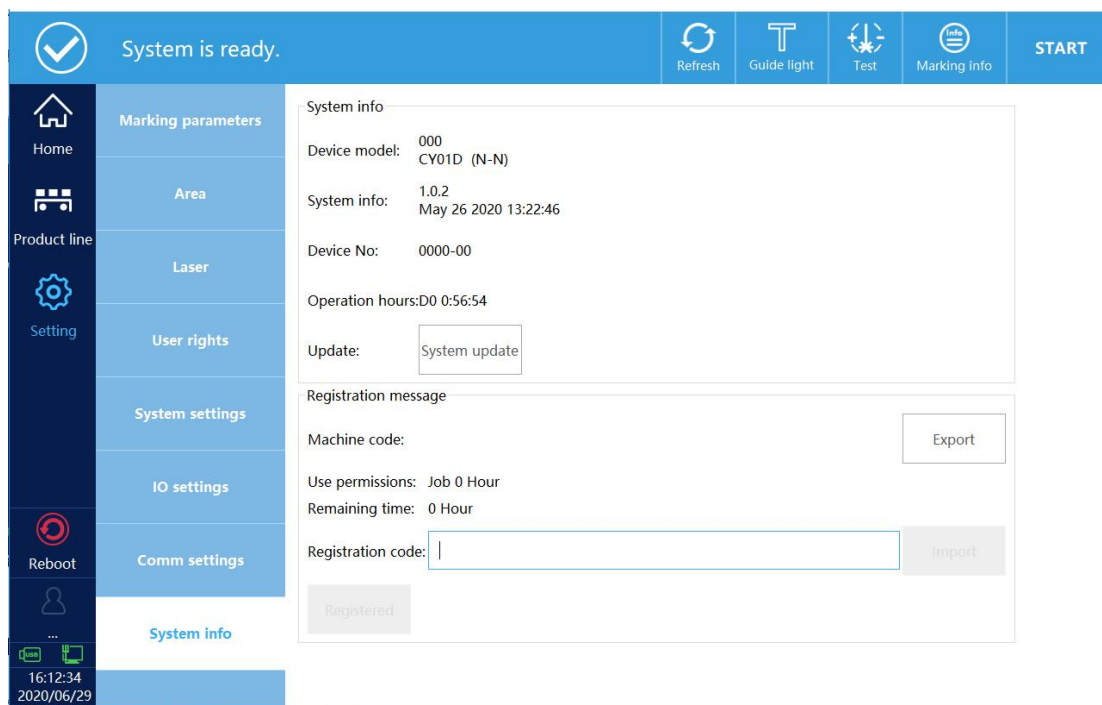


Figure 4- 32

### 4.8.1. System update

System updates include software upgrades and changes to the boot interface.

The software upgrade steps are as follows:

- 1、 Save the update file to the USB flash drive and insert the USB flash drive.
- 2、 Click Software Update, the pop-up interface is shown in Figure 4-33.

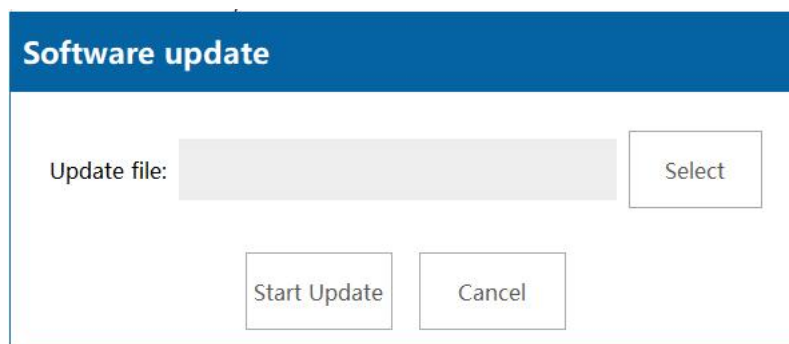


Figure 4- 33

3、 Click to select, the pop-up interface as shown in Figure 4-34.

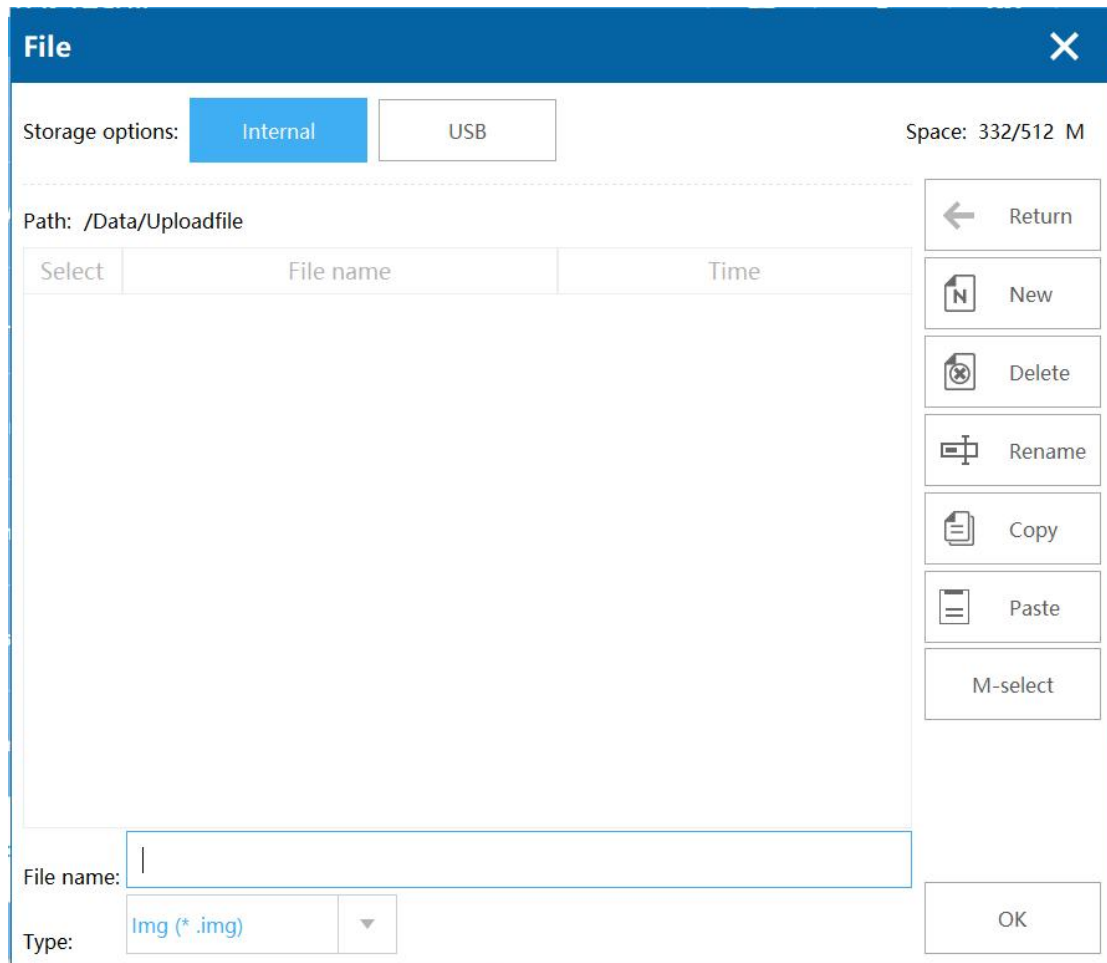


Figure 4- 34

4、 Click USB, select the update file, click OK, click start update.

The steps to change the boot interface are as follows:

- 1、 Boot picture production (format: bmp, resolution: 1280\*800, bit depth: 32,)
- 2、 Name the created picture as a logo, then save the picture and update tool (please ask the staff for the update tool) to the U disk, and then insert it into the USB at the bottom of the screen.
- 3、 Click System Update, the interface pops up, as shown in Figure 4-35.

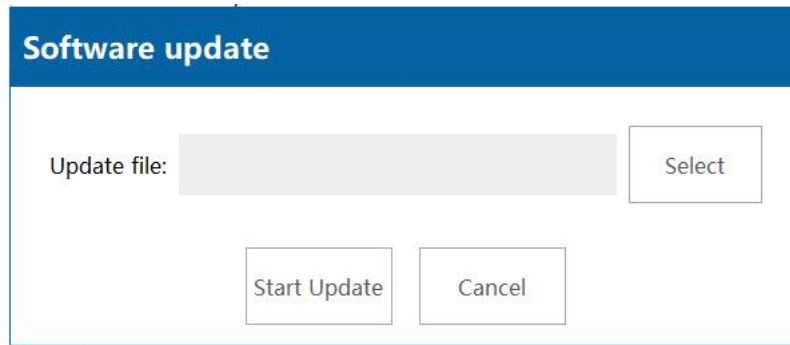


Figure 4- 35

4、 Click to select, click USB, select the update tool, click OK, click to start the update.

### 4.8.2. Registered

Limit software usage time or days.

Proceed as follows:

Step 1: Export the machine code to the U disk, the operation steps are as follows:

- 1、 Turn on the machine and log in to the system (password: 123)
- 2、 Click Settings --- System Information --- Export Machine Code (According to the system prompt to complete the operation)

Step 2: Open the registered software register.exe, as shown in Figure 4-36 (the registered software is sent to the laser manufacturer separately)

The screenshot shows a window titled "Register" with the following elements:

- Machine code:** A text input field with an "Import" button to its right.
- Secret key:** A text input field.
- Limits:** A section containing three radio buttons: "Limited hours" (selected), "Limited days", and "No limit". Below these is a "Time:" label and a text input field.
- Generate:** A button centered below the "Limits" section.
- Register code:** A text input field with a "Save" button to its right.

Figure 4- 36

Step 3: Import the machine code (Note: The machine code can be directly exported from the operation screen to the U disk, and the specific operation is completed according to the prompts on the screen)

Step 4: Set the secret key (the secret key is the secret key of the machine, you must keep in mind that the next time the machine is registered, you must use the secret key to register)

Step 5: Set the time limit or days of use, and also lift the limit

Step 6: Production registration code, save to U disk, as shown in Figure 4-37

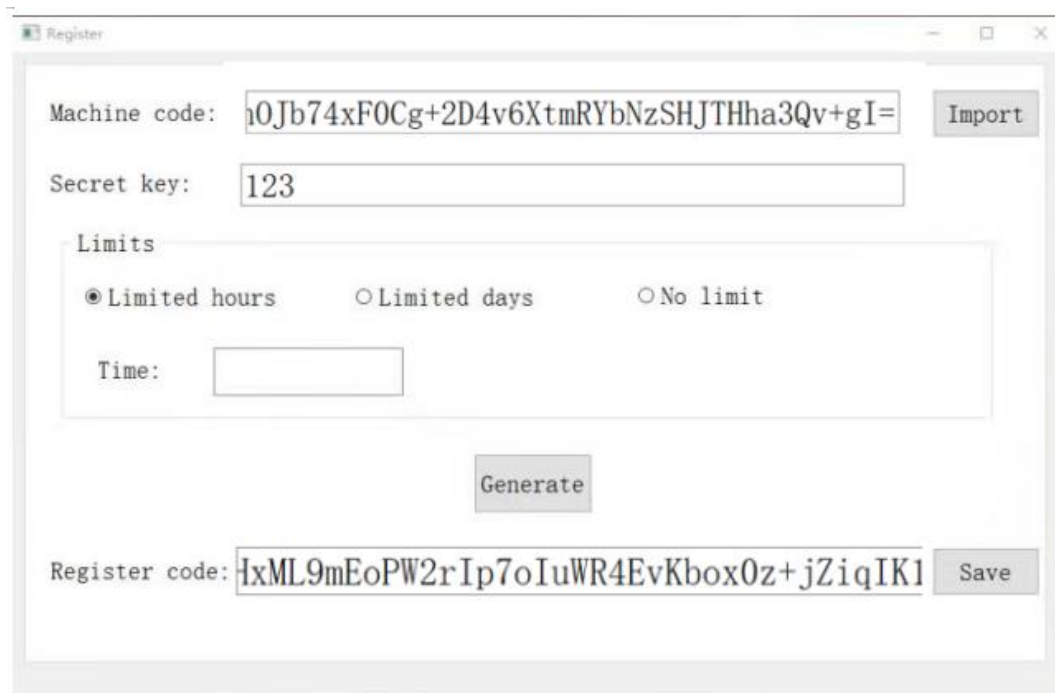


Figure 4- 37

#### Step 7: Register on the machine

- 1、 Login user, password 123 (administrator)
- 2、 Click Settings ---- System Information, import the registration code (TXT file saved in the U disk before)
- 3、 Click to register

## 5. Alarm information

**System error:**Click to open the settings --- detection settings --- enable detection (this function is used by developers, no need to tick during normal use).

**Data initialization failed:**When the data marking time is very long, click the test code and then click to start the code, there will be data initialization failure. (Re-switch the marking mode to remove the fault).

**System warning 3000:**The system failed to communicate with the  
lightwave laser.

**System warning 3001:**Warming up.